



Parks, Recreation & Open Space Dedication and Development Criteria Manual

September 2021



Mission:

Encouraging active lifestyles and creating healthy environments for people, nature and community.

INSIDE OF MANUAL COVER INTENTIONALLY LEFT BLANK

ADMINISTRATIVE APPROVAL

2021 MANUAL UPDATE

This manual was administratively approved by the Director of the Parks, Recreation & Open Space Department (PROS). Policies relevant to the provision of parks, recreation and open space under the purview of PROS are contained herein.

Dedication and development criteria were first adopted by City Council into City Code in 2004. The first comprehensive compilation of criteria into a separate, administratively approved document occurred in 2006. This 2021 manual reflects revisions to the criteria that have been made up to the effective date of this edition, as noted below.

This manual may be further revised in the future upon approval of the Director. Please refer to PROS' website using the following URL where the most up-to-date version and addendums will be posted:

<https://www.auroragov.org/cms/One.aspx?portalId=16242704&pageId=16599586>

Brooke S Bell

9-27-2021

Director, PROS

Date

NOTE: This 2021 manual update involves amendments to Section 3.8 only. Since no other revisions were made elsewhere in the manual, this new version is released as the 2020 manual in its entirety but with the cover, this page, and pages 22 through 24 replaced. The purpose of these amendments is to revise the land dedication criteria to allow certain lands which flood to receive credit for open space purposes.

THIS PAGE INTENTIONALLY LEFT BLANK

TABLE OF CONTENTS

<u>Section 1: Overview and Administration</u>	<u>PAGE</u>
1.1 – Purpose of the Manual	1
1.2 – General Authority	1
1.3 – Revisions	1
1.4 – Interpretation and Applicability	1
1.5 – Relevant Documents	3
1.6 – Adjustments	4
 <u>Section 2: Dedication & Development Fundamentals</u>	
2.1 – PROS Classification System	5
2.2 – Key Sites and Uses	5
2.3 – Partnership with the Development Community	5
2.4 – Developer Obligations	6
2.5 – Partnership Scenarios	6
 <u>Section 3: Land Dedication</u>	
3.1 – Land Dedication Requirements	11
3.2 – Cash-in-Lieu of Land Dedication	13
3.3 – Land Dedication Calculation Methodology	15
3.4 – Subdivision Plat Language for Land Dedication	16
3.5 – Site Plan Note Regarding Dedicated Land	17
3.6 – Due Diligence Prior to Land Dedication	17
3.7 – Land Dedication Planning Principles	17
3.8 – Land Dedication Criteria	22
 <u>Section 4: Park Development Fees</u>	
4.1 – Park Development Fee Requirements	25
4.2 – Fee Calculation Methodology	26
4.3 – Fee Tracking	27
4.4 – Other PROS-related Fees	27
 <u>Section 5: Facility and Resource Protection</u>	
5.1 – General	29
5.2 – City Charter and City Code Protections	29
5.3 – Protected Sites	30
5.4 – Stewardship	31
 <u>Section 6: Design Criteria</u>	
6.1 – General	39
6.2 – PROS Classification System	39
6.3 – Design Principles	41
6.4 – Organization of Design Criteria	44
6.5 – Regional Park Criteria	44
6.6 – Large Urban Park Criteria	45
6.7 – Special Use Park Criteria	46
6.8 – Community Park Criteria	47

TABLE OF CONTENTS (Cont.)

	<u>PAGE</u>
6.9 – District Park Criteria	49
6.10 – Neighborhood Park Criteria	49
6.11 – Pocket Park Criteria	53
6.12 – Mini Park Criteria	55
6.13 – Small Urban Park Criteria	57
6.14 – Golf Course Criteria	62
6.15 – Landscaped Median Criteria	63
6.16 – Natural & Conservation Area Criteria	71
6.17 – Cultural & Historic Site Criteria	72
6.18 – Greenway & Greenbelt Criteria	73
6.19 – Criteria for Open Space Resources	74
6.20 – Trail & Path Criteria	77
6.21 – Landscape-related Criteria	84
6.22 – Facilities & Programmatic Elements Criteria	87
 <u>Section 7: Planning & Design Process</u>	
7.1 – Planning & Design Fundamentals	93
7.2 – Master Planning Process	95
7.3 – PROS Design Review Process	99
7.4 – Required Reports and Plans for Submittal	100
7.5 – Drafting and Graphic Standards	102
 <u>Section 8: Construction Process</u>	
8.1 – Construction Fundamentals	107
8.2 – Pre-construction Phase	107
8.3 – Construction Phase	108
 <u>APPENDICES:</u>	
Appendix A – Land Dedication Code Excerpt	A-1
Appendix B – Park Development Fee Code Excerpt	B-1
Appendix C – Capital Impact Fee Code Excerpt	C-1
Appendix D – Park and Open Space Standard Equipment	D-1
Appendix E – Standard Irrigation Equipment	E-1
Appendix F – Fencing Guidelines	F-1
Appendix G – Tree Protection Policies	G-1
Appendix H – PROS Drafting Standards	H-1
Appendix I – Standard Technical Specifications	I-1
Appendix J – Standard Details	J-1

SECTION 1

OVERVIEW & ADMINISTRATION

1.1 PURPOSE OF THE MANUAL

The *PROS Dedication & Development Criteria Manual* is a guide for the planning, design, construction, management and operation of parks, recreation sites and open space areas provided under the authorities granted to the Parks, Recreation & Open Space Department (hereinafter referred to as “PROS”). As such, this manual establishes minimum criteria to be followed by PROS and non-city entities, such as the development community (i.e., developers and builders and their consultants and contractors) to ensure that goals, policies, procedures and standards for a quality parks, recreation and open space system are implemented as the city continues to grow and develop.

1.2 GENERAL AUTHORITY

This manual was administratively approved by the Director of PROS. The authority of the Director to approve this compilation of dedication and development criteria is set forth as follows:

- Pursuant to Charter Section 7-4, City Code Section 2-142, and Ordinance No. 09-31, the Director has the duty, responsibility and power to “*plan, develop, maintain, construct, manage and operate public parks, special use parks, athletic fields and outdoor sports complexes, off street trails, right-of-way landscaping, public facilities and open spaces throughout the city.*”
- City Code Section 146-4.3.17 specifies: “*Park land and open space areas shall be planned, designed and constructed in compliance with the standards and specifications established by this UDO, including without limitation Sections 146-4.3 (Subdivision Standards), Section 146-5.4.2 (Subdivision of Land), the Aurora City Code, and adopted regulations including all standards and requirements set forth in the Parks, Recreation and Open Space Dedication and Development Criteria Manual.*”

1.3 REVISIONS

Revisions to this manual may be administratively adopted annually and as often as needed. Revisions will be made as a result of industry, management policy, planning, and design standard changes. It is the responsibility of the developers and their consultants to obtain the latest revisions from the city.

1.4 INTERPRETATION AND APPLICABILITY

In the interpretation and application of the provisions of this manual, the following shall govern:

- A. **MINIMUM REQUIREMENTS** – These criteria shall be regarded as the minimum

requirements for the protection of the health, safety and welfare of the residents of the city as it relates to PROS' assets and resources and shall be liberally construed to further such purposes.

- B. **CODE** – Wherever a provision of this manual is inconsistent with City Code, the City Code shall control.
- C. **PERMITS & PLAT APPROVALS** – These requirements shall not abrogate or annul any permits issued before their effective date; any construction plans approved before their effective date; or any final plat documents that have been recommended for approval by the planning commission prior to their effective date.
- D. **REVIEW & APPROVAL** – PROS staff are included in the plans review function administered by other departments, including those for development applications (DAs) that are processed by the Planning and Development Services Department and civil engineering construction plans (civil CDs) that are processed by the Public Works Department. Reviews are conducted to:
- Provide the residents of the city with an interconnected parks, recreation and open space system that has the quantity and quality of lands and facilities to enhance their quality of life.
 - Build partnerships between the city, developers and other public and private entities that collectively serve the parks, recreation and open space needs of city residents.
 - Foster implementation of the city's parks, recreation and open space system goals and plans.
 - Ensure compliance with City Code requirements.

An approval by PROS through the plans review process does not relieve the developer or consultant from the responsibility of ensuring that all plans, designs, calculations, specifications, and construction and as-built drawings are correct and in compliance with the criteria in this manual.

- E. **APPLICABILITY OF CRITERIA IN EFFECT** – The following rules shall determine the criteria to be applied during plan review:
- (1) Development Applications – Manual criteria in effect at the time that a DA is initially filed with the Planning and Development Services Department shall apply. Subsequent submittals of DAs prior to their approval by the city shall not be required to comply with later changes to any criteria, except that applications deemed to be inactive or expired shall comply with the manual in effect at the time of their reactivation/extension. Amendments to approved plans shall also adhere to the manual in effect at the time of the amendment application. This provision applies to each discrete DA. Applicable criteria may change, for example, from the time that a master plan is approved and a site plan, preliminary plan or final plat is filed.
 - (2) Civil Engineering Construction Plans – Manual criteria in effect at the time that civil CDs are initially submitted to the Public Works Department shall apply.

Subsequent submittals of civil CDs prior to their approval by the city shall not be required to comply with later changes to any criteria, except that plans deemed to be inactive or expired shall comply with the manual in effect at the time of their reactivation/extension. Revisions to approved plans shall also adhere to the manual in effect at the time of submittal for review.

1.5 RELEVANT DOCUMENTS

This manual may not be the sole source which outlines developer obligations related to parks, recreation and open space. Other documents that may set forth applicable requirements include the following:

- A. **CITY CODE & ASSOCIATED ADMINISTRATIVE RULES** – The City Code is a compilation and codification of the City Charter and all ordinances of a general and permanent nature into a single document. Code basically outlines the laws of the city. Land use, zoning, subdivision and development regulations that have implications on parks and open space areas are included therein. Rules that are administratively approved by the city may also need to be considered.
- B. **REGULATORY PLANNING DOCUMENTS** – Regulatory planning documents generally consist of two types: official city plans and developer-initiated plans. Developers are advised to thoroughly research these documents to evaluate the degree to which they may impact projects.
 - (1) Official City Plans – Official city plans include policy documents adopted by City Council as a tool to guide growth and development. Such documents may address general citywide planning goals and objectives or focus on defined land use matters. The city comprehensive plan (i.e., *Aurora Places*) is an example of a broad, citywide plan.
 - (2) Developer-initiated Plans – The city requires approval of developer-initiated plans prior to the subdivision or development of land or the issuance of building permits for improvements and construction. Although these plans (DAs and civil CDs) are processed by the Planning and Development Services and Public Works departments, they are also concurrently reviewed by PROS staff when projects are deemed to impact the existing or planned parks, recreation and open space system.
- C. **ANNEXATION AGREEMENTS** – Annexation agreements set mutually agreed upon terms and conditions for the provision of public facilities and services, including parks and open space areas, to a subject annexation territory. Annexor/Developer obligations may be established by these, particularly if other agreements or City Code provisions do not take precedence.
- D. **DEVELOPMENT AGREEMENTS** – Development agreements are legally enforceable documents that establish special terms and conditions mutually agreed between the city and the developer to enable a development to proceed. Special provisions may deal with park and open space matters.

- E. **COURT DECISIONS** – Additional factors that may affect a development include court mandates and judicial rulings. Because of their unique nature, potential impacts cannot be described other than to acknowledge that they may establish separate requirements to be fulfilled by developers.

1.6 ADJUSTMENTS

In the spirit of cooperation and partnership with the development community, PROS recognizes that strict adherence to the standards and requirements herein may not be appropriate or necessary in all cases; and criteria may be adjusted accordingly. Options for alternatives to the requirements of this manual may be considered.

- A. **CRITERIA FOR APPROVAL** – It shall be the responsibility of the entity proposing deviation from the requirement to demonstrate to the satisfaction of PROS that the proposed adjustment complies with the following standards:
- (1) Whether the proposed development includes parks, recreation and open space areas and facilities that serve specific public needs and that will provide services and benefits for all of the city's citizens.
 - (2) The degree or extent to which the proposed parks, recreation and open space areas and facilities are consistent with all other applicable standards, guidelines, policies and plans adopted by City Council.
 - (3) The overall quality of design proposed for the development, including the extent to which proposed adjustments from minimum criteria are offset by specific design actions or treatments that mitigate otherwise negative impacts from uses and facilities that do not meet development requirements.
 - (4) The appropriateness of design strategies for proposed parks, recreation and open spaces areas and facilities, including their accessibility and integration into the development, adjacent development and the surrounding community.

SECTION 2

DEDICATION & DEVELOPMENT FUNDAMENTALS

2.1 PROS CLASSIFICATION SYSTEM

PROS uses a classification system to describe and categorize its parks, recreation and open space landholdings. Refer to Section 6.2 of this manual. The classification system, includes a multitude of different types of sites that collectively serve the entire city population, but a few components stand out as playing a more pivotal role in meeting residents' basic needs:

- Neighborhood parks, community parks, and open space are considered the building blocks of PROS' strategy for expanding its system in conjunction with the development community as the city continues to build out.

2.2 KEY SITES AND USES

In the late 1990s, a study was conducted to characterize representative residential density and development patterns anticipated to occur in the developing parts of Aurora. This exercise involved identifying "model" areas within the city that generally had a good supply of parks and open space. Mapping analyses of the then existing park and open space acreage and population distribution were prepared. Public input was sought and taken into account as the vision for the ideal amount of acreage needed to serve the fundamental needs of the population took shape.

The study recommended population-based acreage goals for park and open space use. City Council endorsed the analysis, including the recommendations for growth of the park and open space system into the future. The acreage goals are established as formal city policy in Section 146-4.3.18.B of the City Code, which spells out the land dedication standards that are currently imposed upon new development. The policy requires that for every 1,000 persons, no less than the following acreages should be set aside for park and open space purposes:

- 3.0 acres of neighborhood park land.
- 1.1 acres of community park land.
- 7.8 acres of open space land.

2.3 PARTNERSHIP WITH THE DEVELOPMENT COMMUNITY

PROS and the development community have a history of working together to enhance the parks, recreation and open space system to serve the growing population that their developments introduce into the city. This partnership occurs not only because the city mandates that developers and builders help to expand the system, but also because the development community recognizes that providing these community assets helps to make new development more attractive, livable and marketable, thereby building a quality community. Continuation of this partnership enables the city to strengthen its already successful park legacy to enrich the existing city and tomorrow's neighborhoods.

PROS welcomes collaboration with the developers and consultants early in the process as developments are being designed in order to help define approaches that will meet the park, recreation and open space needs of the residents that will reside in them. Staff will strive to reach mutually beneficial solutions to create appropriate park, recreation and open space components for proposed developments that are in accord with the dedication and development criteria of this manual.

2.4 DEVELOPER OBLIGATIONS

When new development occurs in the city, its impact on the park and open space system is generally two-fold – both additional land and park facilities are needed to serve the population influx. Although unique circumstances may come into play in determining the exact requirements that apply to a specific development property, developer obligations typically are as follows:

- A. **LAND DEDICATION** – If a developer must dedicate land for park and/or open space purposes, the obligation is typically met in one of two ways:
 - (1) Option 1 – Dedicate land on-site within the development property.
 - (2) Option 2 – At the discretion of the City Manager, make a cash payment to PROS in lieu of dedicating land on-site.

- B. **PARK DEVELOPMENT** – When a developer must dedicate land for park purposes, the obligation is usually also paired with a requirement to improve the park land by constructing designated park facilities. This obligation is typically satisfied in one of two ways:
 - (1) Option 1 – Construct each respective type of park with the specified programmatic elements (i.e., facilities) on-site within the development property.
 - (2) Option 2 – Instead of constructing park facilities on-site, pay fees to the city to cover the cost for PROS to improve the park land either on-site or to build facilities elsewhere in the city to serve the future development's residents.

2.5 PARTNERSHIP SCENARIOS

City policy allows developers to decide whether they want to assume responsibility for developing dedicated on-site park land and whether they also want to retain ownership of the parks, thereby taking on responsibilities for the long-term operation and maintenance of the land and facilities as well. With these choices, typical scenarios which describe the conventional ways developers meet their combined obligations for land dedication and park development are described below.

It should be noted that there can be hybrid versions of the scenarios. Unique circumstances of projects may warrant approval of special variations on a case-by-case basis.

A. **SCENARIOS FOR NEIGHBORHOOD PARKS:**

- (1) Neighborhood Park Scenario #1 – Develop, own and maintain the park land by a non-city entity, such as a metropolitan district or homeowner’s association.
Commentary: Potential benefits of developers choosing to retain ownership and maintenance responsibility of the parks they provide are as follows:
- Developers can take advantage of the economies of scale with having their own contractors construct a park for a lower cost than what they would likely pay PROS (through park development fees collected per residential unit building permit) to undertake the construction.
 - The design and development standards for a non-city park are not as prescriptive as the specifications that apply to parks that will be owned and maintained by PROS.
 - For marketability benefits, developers may prefer to construct the parks within their developments to coincide with planned phasing and sales schedules. (If the developers do not construct the parks as the new neighborhoods are created, future residents may be not be adequately served by park facilities for a considerable period of time until funds become available for PROS to undertake park development.)
 - When parks are managed by metropolitan districts, homeowner’s associations or other private entities, the level of maintenance can be based on local preferences, practices and schedules.
- (2) Neighborhood Park Scenario #2 – Develop and dedicate the park land to the city.
Commentary:
- Under this scenario, developers choose to construct the park(s) and turn the site(s) over to PROS for long-term operation and maintenance. Additionally, the city accepts ownership of the park land.
 - Parks to be maintained by PROS after they are constructed must follow different, more prescriptive design and development standards than those that apply to parks which will be owned and maintained by a non-city entity. For example, a public outreach process for the preparation of a park master plan is required, as are park construction documents that must be submitted (along with plan review fees) for detailed staff review and approval. Certain brands of equipment must be installed at these parks for system consistency and maintenance reasons. Final inspection is required and as-built plans must also be provided upon completion of construction prior to PROS acceptance of maintenance responsibility.
- (3) Neighborhood Park Scenario #3 – Dedicate undeveloped park land to the city and pay park development fees.
Commentary:
- If this is the decision made by developers, all responsibility to own, plan, design, construct, and maintain the park land dedicated to the city is placed on PROS. Park design and construction occur when sufficient fees have been collected to fund park development.
- (4) Neighborhood Park Scenario #4 – Pay cash-in-lieu of on-site park land dedication and pay park development fees.

Commentary:

- When a property is not large enough to accommodate a neighborhood park within a development, developers fulfill their obligation by making monetary payments to PROS. PROS uses this money for capital projects, including land acquisitions and park development projects, at alternative locations to serve the residents.

B. SCENARIOS FOR COMMUNITY PARKS:

The partnership scenario choices for community parks are fewer because most developments are too small to warrant the provision of a full-sized community park on-site. It takes a projected population of approximately 36,400 persons to trigger a 40-acre community park land dedication requirement. For this reason, only very large developments are typically able to satisfy this portion of their park land dedication obligation on-site. Projects that have lower population impacts must adhere to the third scenario by paying cash-in-lieu of land dedication.

Developers may not retain ownership and maintenance responsibility of community parks. Instead, these parks must be dedicated to the city so that the land and facilities can be managed and programmed according to PROS' needs and schedules.

- (1) Community Park Scenario #1 – Develop and dedicate the park land to the city.

Commentary:

- Under this scenario, developers choose to construct the park and turn the site over to PROS for long-term operation and maintenance. Additionally, the city accepts ownership of the park land.
- The park must be designed and developed following prescriptive standards. A public outreach process for the preparation of a park master plan is required, as are park construction documents that must be submitted (along with plan review fees) for detailed staff review and approval. Certain brands of equipment must be installed for system consistency and maintenance reasons. Final inspection is required and as-built plans must also be provided upon completion of construction prior to PROS acceptance of maintenance responsibility.

- (2) Community Park Scenario #2 – Dedicate undeveloped park land to the city and pay park development fees.

Commentary:

- If this is the decision made by developers, all responsibility to own, plan, design, and develop the park land dedicated to the city is placed on PROS. Park design and construction occur when sufficient fees have been collected to fund park development.

- (3) Community Park Scenario #3 – Pay cash-in-lieu of on-site park land dedication and pay park development fees.

Commentary:

- When a property is not large enough to accommodate a community park within a development, developers fulfill their obligation by making monetary payments to PROS. PROS uses this money for capital projects, including

land acquisitions and park development projects, at alternative locations to serve the residents.

C. SCENARIOS FOR OPEN SPACE:

- (1) Open Space Scenario #1 – Dedicate open space land to the city and construct open space improvements.

Commentary:

- In addition to dedicating land for open space purposes, developers will be required to make improvements, such as constructing trails, as well as revegetating and restoring disturbed areas. Not only do the trails open up access to the open space, they also enhance connectivity to adjacent and surrounding areas. This requirement is supported by several sections of the City Code specifying how new developments shall provide a safe, continuous pedestrian and bicycle network that minimizes conflict with automobiles while promoting a convenient option for movement within and between developments.

- (2) Open Space Scenario #2 – Pay cash-in-lieu of on-site open space land dedication.

Commentary:

- When a property is not large enough to provide qualifying open space as part of a development, developers fulfill their obligation by making a monetary payment to PROS. PROS uses this money to acquire and improve open space at alternative locations to serve the residents.

For information about calculating cash-in-lieu of land dedication payments and park development fees, if applicable to the above scenarios, refer to Sections 3 and 4 of this manual, respectively.

D. SCENARIOS FOR LANDSCAPED MEDIANS:

City policy requires developers to construct interior streets and half of the perimeter streets serving their respective projects. Street construction responsibility also includes developed medians if any of the streets are classified as arterials and not otherwise approved for painted medians.

Although developers are required to maintain the medians within *minor* arterial streets, they also sometimes accept responsibility to maintain *major* arterial medians. It is an option of the developer to choose whether major arterial medians will be maintained by a non-city entity or PROS.

- (1) Landscaped Median Scenario #1 – Develop and maintain the median by a non-city entity, such as a metropolitan district, homeowner’s association or other private entity.

Commentary: Potential benefits of developers choosing to accept maintenance responsibility of landscaped medians are as follows:

- The design and development standards for a non-city maintained median are not as restrictive as the specifications that apply to medians that will be owned and maintained by PROS. Therefore, these medians may be developed according to themes matching the private development.

- For marketability benefits, developers may prefer to construct the medians within their developments to coincide with planned phasing and sales schedules. This is because if they do not improve the medians as the roads are built, their condition may detract from the positive image of the new neighborhoods for a considerable period of time until funds become available for PROS to improve them.
- Non-city maintenance by metropolitan districts, homeowner’s associations or other private entities can ensure that the level of care given to the medians will match the expectations of developers and homeowners. (Maintenance by PROS might not be performed as frequently or in accordance with standards of others.)
- An Intergovernmental Agreement (IGA) between the city and the non-city entity must be executed to outline the terms and conditions of maintenance responsibilities.

(2) Landscaped Median Scenario #2 – Develop the median to be maintained by PROS.

Commentary:

- Developers constructing any landscaped median under this scenario must adhere to the design criteria presented in Section 6.15. These criteria are less flexible than if the median were to ultimately be maintained by a metropolitan district, homeowner’s association or other private entity. For example, there is less flexibility in plant material selection in order to keep the median xeric-based (i.e., water conserving). Similar to park projects, final inspection approval and as-built plans must also be provided upon completion of construction prior to PROS acceptance of maintenance responsibility.

SECTION 3

LAND DEDICATION

3.1 LAND DEDICATION REQUIREMENTS

Land dedication requirements set forth in Section 146-4.3.18.B of the City Code (refer to Appendix A) are imposed to provide parks and open space areas for new neighborhoods and to address the impacts of additional residents within existing neighborhoods. It is also with these dedications that critical linkages to the greenway and trail network in the city are facilitated.

- A. **LEVEL OF SERVICE STANDARDS** – The following land dedications are required by Code:
- 3.0 acres per 1,000 residents for neighborhood parks.
 - 1.1 acres per 1,000 residents for community parks.
 - 7.8 acres per 1,000 residents for open space, other park uses and trails.
- B. **AVERAGE HOUSEHOLD SIZES** – Average household sizes for different residential unit types are used, in part, to calculate land dedication requirements by projecting the future population of a residential development so that the level of service standards can be applied. The average household sizes, which are based on census data, are as follows and may be modified as determined by the City Council when new numbers become available from the Census Bureau and other reliable sources:
- 2.65 persons per single family dwelling unit.
 - 2.50 persons per multi-family dwelling unit.
 - 2.02 persons per dwelling unit in a transit station area.
 - 1.58 persons per dwelling unit in an active adult community.
- C. **CHANGE IN LAND USE & RESIDENTIAL DENSITY** – For developments that result in a change in land use and/or residential density that increases the number of residents impacting the existing park and open space system, land dedication requirements shall apply. For purposes of calculating the projected population for such developments, credit shall be given for the population attributed to any existing residential units on site.
- D. **SENIOR HOUSING** – Senior housing developments, or portions of such developments, that are assisted living, continuing care retirement, skilled nursing and convalescent communities or facilities are exempt from all land dedication requirements because the occupants of these projects are not considered to be independently mobile or able to leave the residential facility to use a city park. If a senior housing project is entirely characterized as “active adult” or is comprised of a mix of dwelling unit types including some for active adults and persons under age fifty-five (55), then land dedication requirements will be imposed, but only upon the number of units characterized as active adult or those units intended to be occupied by persons without the age limitation or by residents not in need of personal care or health services.

- E. **QUALIFYING INFILL & TRANSIT STATION AREA DEVELOPMENT** – Development characterized as infill development and development within transit station areas may take advantage of special land dedication criteria. To qualify, such developments must either:
- (1) conform to the definition of infill development parcel, as established by Sec. 146-6.2 of the City Code, or
 - (2) be located within the boundaries of a transit station area, as designated in the city’s comprehensive plan or defined by a city-adopted station area plan.
- F. **INFILL & TRANSIT STATION AREA DEVELOPMENT CRITERIA** – Special dedication and development criteria applicable to infill development and development within transit station areas include the following:
- (1) Land provided in conformance with small urban park (SUP) criteria shall be credited toward satisfying, in whole or in part, neighborhood park land dedication requirements.
 - (2) Land provided to complete or enhance the system of regional trails or greenways that connect bicyclists and pedestrians to major destinations on the development site and to adjacent properties shall be credited toward satisfying, in whole or in part, community park land dedication requirements.
 - (3) Such developments shall be exempt from the 7.8 acres per 1,000 residents open space land dedication requirement.
- G. **URBAN CENTERS** – Development within a qualified “urban center,” as designated in the city’s comprehensive plan, may satisfy the open space land dedication requirement, in whole or in part, by providing lands in conformance with SUP criteria.
- H. **SMALL URBAN PARKS** – Land dedication credit for SUPs may be issued by PROS when in conformance with the site design criteria presented in Section 6.13 of this manual. Despite the applicability of SUP criteria within designated areas described in paragraphs F and G above, a minimum three (3) acre neighborhood park may, at the discretion of PROS, be required when a development introduces more than one-thousand (1,000) residents into a part of the city that is underserved by neighborhood parks. The decision will be based on an analysis of the magnitude of new residents’ park needs and the ability of proposed SUPs to serve these needs, the quantity of existing park facilities within one-half (½) mile service radius of the development, the size of the development, the population density, and the feasibility of integrating a three (3) acre park into the mix of proposed land uses.
- I. **ANNEXATION AGREEMENTS** – Some annexation agreements which precede the current dedication code requirements established public land dedication by a percentage of the gross residential acreage rather than by projected population. In these cases, the annexation agreement prevails unless the proposed land use changes from that approved at the time of annexation. Development without an existing annexation agreement must comply with the dedication requirements of Section 146-4.3.18.B of the City Code.

- J. **PUBLIC USE DEDICATION** – Annexation agreements may also establish a “public use” land dedication requirement based on a percentage of residentially zoned acreage and a percentage of the non-residential acreage. This dedication shall provide for municipal facilities such as fire stations, police stations, libraries, etc. In the absence of any other municipal need, the land dedication shall be provided as open space and meet dedication criteria of this manual.
- K. **UNIQUE SITES** – If a proposed development involves a unique circumstance or opportunity related to parks, recreation and open space that is not thoroughly addressed by the land dedication requirements and other design standards, PROS staff and the developer/consultants may work together, early in the design process, toward a resolution which results in mutual benefit for the developer and the city’s residents. Below are examples of special circumstances that might warrant special land dedications:
- Developments that have extensive natural features or historic/cultural resources worthy of protection.
 - Developments that exhibit extraordinary potential to provide critical regional trail and open space connectivity.
 - Developments that include key lands targeted by the city to satisfy demonstrated or anticipated public facility demands.
 - Transit oriented development projects.
 - Redevelopment and infill projects.
 - Affordable housing projects.

3.2 CASH-IN-LIEU OF LAND DEDICATION

A cash-in-lieu payment to the city may be permitted at the City Manager’s discretion if a development does not provide enough park and open space land to comply with the land dedication standards.

- A. **DISTINCTION FROM PARK DEVELOPMENT FEES** – Cash-in-lieu of land dedication payments are different from park development fees (refer to Section 4 of this manual) that may be paid to the city. Such monies are collected by the city for two distinct purposes. The former monetary payment is collected when required park and open space **land** dedications are not provided on-site, whereas the latter monetary payment is collected when required park **facilities** are not constructed on-site.
- B. **TIMING OF CASH-IN-LIEU PAYMENT** – Cash-in-lieu payments shall be paid at the time that the first final plat for the subdivision is submitted to the city, except under the following circumstances:
- (1) No Plat – For developments involving properties that are already platted or that do not require a plat, cash-in-lieu payments shall be paid prior to Site Plan approval and recordation.
 - (2) Deferral – For mixed use developments, nonresidential plats may be approved and cash-in-lieu payments may be deferred until such time as a final plat involving residential lots or tracts is processed, provided the development also satisfies two supplemental criteria:

- (a) the development qualifies as infill development or a transit station area (refer to paragraph E in Section 3.1); and
- (b) the development is not required to make a public use land dedication (refer to paragraph J in Section 3.1).

C. LAND VALUE CALCULATIONS – Cash-in-lieu payments shall be based on the market value of property within the subdivision as fully developed, with all attendant infrastructure, in accordance with the land uses approved for the subdivision.

- (1) Appraisal – If the developer has a recent appraisal report (current within six months of the date of submittal) or other document, such as a recent or pending agreement of sale, PROS and Real Property Services may review such information to determine whether it adequately reflects an estimated market value for the site and is based on the same assumptions outlined in City Code Section 146-4.3.18.B.

Alternatively, PROS and Real Property Services staff may generate a per-acre value based on their knowledge and judgment of the market. This option may be used if the developer doesn't have a recent appraisal or wants to avoid going to the expense of hiring an appraiser. No report or written analysis is prepared by the city; only a per-acre value is provided for the developer's consideration. The developer shall not be bound to accept the city's number and has the option to still produce an appraisal or agreement with an alternative number for the city to review and approve.

- (a) If the developer and city cannot agree upon the amount of any cash-in-lieu payment, each party shall appoint an appraiser of its choosing, whose fees shall be paid by the appointing party. If the two appraisers thus appointed cannot agree on the amount, they shall jointly appoint a third appraiser whose fees shall be paid half by the developer and half by the city. The amount shall be the average of the two appraisal amounts (out of three appraisals) which are closest to one another in value.
- (2) Infill & Transit Station Area Development Value – For infill development and development within transit station areas that are required to provide cash-in-lieu of land dedication, the amount of such payment shall be based upon a per-acre value derived from a case study analysis of the market value of property acquired by the city for community-based park, recreation, and open space purposes.
 - (a) Such per-acre value shall be determined annually by the Director of PROS in accordance with the provisions of Section 2-587 of the City Code. A value of \$50,900/acre was derived from the 2020 case study.

D. CASH-IN-LIEU PAYMENT TRACKING – Payments received for cash-in-lieu of land dedication are used to provide park and open space facilities to serve the future residents of the development from which they are collected. Once a payment is received, it is deposited into a special account and reserved solely for use by PROS. Using the city's accounting software program, PROS staff is able to identify the geographic area from which the monies were received. Staff ultimately requests approval from City Council to appropriate the money, in its entirety or in part, to fund future capital park projects that service the development as they are budgeted and programmed.

3.3 LAND DEDICATION CALCULATION METHODOLOGY

The methodology used to calculate park and open space land dedication requirements is presented below.

Step 1: Calculate the projected population by multiplying the number of proposed residential units by 2.65 persons per Single Family (SF) dwelling unit, 2.50 persons per Multi-Family (MF) dwelling unit, 2.02 persons per Transit Station Area (TSA) dwelling unit, and 1.58 persons per Active Adult Community (AAC) dwelling unit. Then add the results together to arrive at a total population count.

- A. # of proposed SF units X 2.65 persons = Projected SF Population
- B. # of proposed MF units X 2.50 persons = Projected MF Population
- C. # of proposed TSA units X 2.02 persons = Projected TSA Population
- D. # of proposed AAC units X 1.58 persons = Projected AAC Population
- E. Projected SF Population + Projected MF Population + Projected TSA Population + Projected AAC Population = Total Projected Population

NOTE: The Total Projected Population is rounded off to the nearest whole number.

Step 2: Calculate the acreage of park and open space land required to serve the projected population. (These acreages represent how much Neighborhood Park [NP], Community Park [CP] and Open Space [OS] acreage must be dedicated on-site to meet the needs of the residents of the project. Depending on the annexation agreement, a Public Use [PU] land dedication equaling a percentage of the residentially zoned acreage and a percentage of the acreage zoned non-residential may be required to serve the needs of other municipal facilities, such as police and fire stations, etc.)

- A. Total Projected Population X 3.0 acres of NP Land / 1000 persons = Required NP Acreage
- B. Total Projected Population X 1.1 acres of CP Land / 1000 persons = Required CP Acreage
- C. Total Projected Population X 7.8 acres of OS Land / 1000 persons = Required OS Acreage
- D. (Residentially Zoned Acreage X applicable percentage) + (Non-residentially Zoned Acreage X applicable percentage) = Required PU Acreage

NOTE: The Required NP, CP and OS Acreages are rounded off to the nearest 100th. The balance of the Public Use land dedication acreage not needed for any other municipal purpose shall be counted as an additional open space requirement. The following sub-step may be necessary.

- E. Required OS Acreage from "C" above + (Required PU Acreage from "D" above – Acreage Needed for Public Use other than parks, recreation and open space) = Required OS Acreage

Step 3: (If none or not enough acreage is provided on-site to satisfy the requirement of any category of park or open space land dedication, then a cash-in-lieu payment shall be provided for the balance. This step adjusts the acreages to account for qualifying land dedications.) Adjust the acreages if qualifying park and open space land will be provided on-site as part of the project.

- A. Required NP Acreage – # of acres of NP acreage provided on-site = Adjusted NP Acreage
- B. Required CP Acreage – # of acres of CP acreage provided on-site = Adjusted CP Acreage
- C. Required OS Acreage – # of acres of OS acreage provided on-site = Adjusted OS Acreage

NOTE: A project may not qualify for acreage adjustments if standards for minimum park sizes cannot be met on-site or if the subject site does not include other lands deemed necessary by PROS for the future city parks and open space system.

Step 4: Multiply the adjusted acreages by the estimated per-acre value. (Prior to payment, PROS staff must approve the current fair market value of the land.) Then add the results together to arrive at a total estimated cash-in-lieu payment.

- A. Adjusted NP Acreage X Estimated Per Acre Value = Estimated NP Payment
- B. Adjusted CP Acreage X Estimated Per Acre Value = Estimated CP Payment
- C. Adjusted OS Acreage X Estimated Per Acre Value = Estimated OS Payment
- D. Estimated NP Payment + Estimated CP Payment + Estimated OS Payment = Total Estimated Cash-in-Lieu Payment

NOTE: Criteria for calculating the cash-in-lieu of land dedication payment may vary from the above if an annexation agreement or other legal document approved by the city for the subject development sets forth other applicable rules or guidelines.

Based on a hypothetical residential development comprised of 100 single family detached units, land dedication requirements are calculated in the manner presented in the following example.

Step 1:

A. 100 SF units X 2.65 persons = 265 persons

Step 2:

A. 265 persons X 3.0 acres of NP Land / 1000 persons = 0.80 NP acres

B. 265 persons X 1.1 acres of CP Land / 1000 persons = 0.29 CP acres

C. 265 persons X 7.8 acres of OS Land / 1000 persons = 2.07 OS acre

NOTE: This example assumes there is no PU land dedication requirement.

Step 3:

A. 0.80 NP acres – 0.00 acres = 0.80 NP acres

B. 0.29 CP acres – 0.00 acres = 0.29 CP acres

C. 2.07 OS acres – 0.00 acres = 2.07 OS acres

NOTE: This example assumes there is no land within the subject site that has been targeted or appropriate for the city parks and open space system.

Step 4:

A. 0.80 NP acres X \$100,000 per acre = \$80,000 Estimated NP Payment

B. 0.29 CP acres X \$100,000 per acre = \$29,000 Estimated CP Payment

C. 2.07 OS acres X \$100,000 per acre = \$207,000 Estimate OS Payment

D. \$80,000 + \$29,000 + \$207,000 = \$316,000 Total Estimated Cash-in-Lieu Payment

NOTE: This example assumes an estimated value of \$100,000 per acre. (The actual per acre value shall be determined on a project-specific basis taking into account appraisal data, comparable sales data, and/or a case study analysis of the market value of property acquired by the city for community-based park, recreation, and open space purposes.)

3.4 SUBDIVISION PLAT LANGUAGE FOR LAND DEDICATION

In addition to being clearly mapped and identified using text/narrative and tabular data in master plans and site plans (as required by the Planning & Development Services Department), property provided to satisfy land dedication requirements shall be designated as such on preliminary and final plats in accordance with the following requirements:

- Land which is receiving credit toward park and/or open space land dedication requirements shall be indicated on the plat with a note and/or label stating “...for public purposes.”
- If the land is also required to be dedicated for additional municipal uses, such as for drainage/utility purposes, the above phrase shall be in addition to text required by the other city departments.

Dedication by subdivision plat does not constitute acceptance of maintenance responsibility by the city. Park and open space related improvements shown in approved DAs and civil CDs must be completed to PROS’ satisfaction before responsibility for the dedicated property is accepted. Refer to Section 8.3 for procedures required before the city will take over maintenance of a site.

3.5 SITE PLAN NOTE REGARDING DEDICATED LAND

The following note shall be included on the cover sheet of all site plans and preliminary plats to acknowledge that dedicated park and open space land as well as the improvements upon such land must be open for use by the general public:

- Parks, recreation improvements, trails, and open space areas provided to satisfy land dedication requirements in accordance with approved development plans or provided by a metropolitan district or other appropriate jurisdiction or owners association in accordance with approved metropolitan district service plans shall be open to the general public.

3.6 DUE DILIGENCE PRIOR TO LAND DEDICATION

The city and its agents shall be given the right by the landowner to enter upon the property to conduct any studies, inspections, surveys, and testing of lands proposed to be conveyed to the city to satisfy PROS' land dedication requirements. A determination of whether property is accepted or rejected shall be made by PROS, in its sole and absolute discretion, after review of due diligence investigations, studies, and reports that may be required, including but not limited to the following:

- A. TITLE COMMITMENT** – A policy from an underwriter that will provide for “extended” coverage over the standard exceptions for the property showing all liens, encumbrances, and other matters affecting title to the real property, including severed mineral rights ownership.
- B. ENVIRONMENTAL TESTING / ASSESSMENT** – A phase I environmental site assessment or other form of substitute site evaluation regarding the environmental risk associated with the property.
- C. FEASIBILITY STUDY / ANALYSIS** – A study of land use, building, and construction regulations as well as economic circumstances that affect the potential use of the property for its intended purpose(s).

Staff from PROS and the Real Property Services Division of the Public Works Department shall define on a case-by-case basis any due diligence documentation that may be warranted to aid in deciding whether the city should accept land offered for dedication. Such documentation may be required from developers at their expense.

3.7 LAND DEDICATION PLANNING PRINCIPLES

Planning principles shall aid in determining where park land and open space areas to meet land dedication requirements should be located.

- A. CONSISTENCY** – Dedicated land shall be set aside so as to be consistent with land use and site planning objectives:

- (1) Spirit & Intent – Be compatible with the spirit and intent of PROS master plans, the city comprehensive plan, requirements of City Code, and other policies and plans adopted by City Council.
- (2) Surrounding Land Uses – Be compatible with surrounding land uses, both existing and planned, in order to protect natural features and processes and to integrate open space and natural areas into developed areas for both visual diversity and the definition of neighborhood/community character.
- (3) Site Suitability – Be compatible with the physical characteristics of the land, ensuring that sites are favorable for their intended purpose and use. For example, a flat, open site rather than a very hilly site is more conducive to athletic field construction if a sports field complex is expected to be the key programmatic element of a new park. Likewise, if the goal is to provide a place to offer nature study and interpretative opportunities, then a location with intact natural features should be of prime importance in site selection.

B. RECREATIONAL, CONSERVATION & EDUCATIONAL VALUE – Land dedicated for parks and open space uses shall have recreational, conservation, or educational value.

- (1) Recreational Value – Public recreation activity takes many different forms because the way in which people recreate is a personal choice governed by individual interests. Therefore, the ways in which lands can be improved to satisfy public recreation needs vary as well. Below are examples of how to provide recreational value within parks and open space areas:
 - (a) The provision of facilities primarily oriented to active recreation, including athletic fields, sports courts, playgrounds, etc. (In some cases, benefits to the community may be achieved through efficiencies in site use by coordinating with school districts to offer joint facilities.)
 - (b) The provision of facilities for contemplative recreation, including seating areas and enhanced landscaped areas for gathering and passive recreation.
 - (c) The provision of open grass areas that offer scenic vistas and visual relief from developed areas but that also serve as places for field games and casual recreation activity.
 - (d) The provision of site furnishings to compliment nearby uses and facilities.
 - (e) The provision of trails and paths.
- (2) Conservation Value – Public lands are commonly set aside to guard, protect and preserve natural resources from the hazardous effects of development, to maintain natural process, and to safeguard people and property from certain natural hazards. Natural features that are sensitive to disturbance and alteration, lands that pose constraints on development, and areas that play a significant ecological role can become important conservation areas within a park or open space area. Ways in which conservation values can be integrated to receive land dedication credit include:

- (a) Reclaim and restore creeks, wetlands, steep slopes, wooded areas, etc. that have been degraded.
 - (b) Create features within new developments that provide a naturalized amenity where prior to development there was no conservation value.
 - (c) Undertake habitat enhancement projects that benefit plant and animal species, thereby promoting wildlife and habitat protection.
 - (d) Coordinate development design with planning for historic and cultural resources.
 - (e) Foster the concept of outdoor classrooms by setting aside natural areas that have overlapping resources of value and interest for environmental study.
 - (f) Preserve land to establish an interconnected park and open space system throughout the city.
- (3) Educational Value – Parks and open space lands are places that can be used to inform and educate residents. There are often plentiful opportunities to interpret the features within a park and open space or to teach about related subjects. Below are some examples of how educational benefits can be derived through site improvements and land use.
- (a) The provision of signs, displays, etc. for environmental education for self-guided learning or programmed tours dealing with topics such as:
 - (i) The study of plants and animals.
 - (ii) Historical site and cultural resource interpretation.
 - (iii) Scenic view interpretation.
 - (iv) Natural area interpretation and the study of natural processes.
 - (v) Teaching about the relationships between different elements of the environment and between people and the environment.
 - (vi) Teaching a conservation ethic and stewardship.
 - (b) The provision of hardscape improvements as well as landscape planting to support interpretation goals.
 - (c) Implementation of land management practices to support interpretation goals.

C. **PARK SERVICE AREA GUIDELINES** – Service area guidelines shall be used to decide where park land should be dedicated within new development to prevent areas where people live too far from parks to be reasonably served by them. These guidelines, which are expressed in terms of straight-line distances (radii) from park boundaries, help to ensure that parks are well distributed throughout the city:

- (1) Community Parks – Residents should not be farther than 2 miles from a community park.

- (2) Neighborhood Parks – Residents should not be farther than ½-mile from a neighborhood park.
- (3) Small Urban Parks – SUPs have service area standards that vary based on the size of the park:
 - (a) SUPs less than one-half (½) acre in size shall be considered to serve residents living no farther than one-quarter (¼) mile away.
 - (b) SUPs equal to or greater than one-half (½) acre in size shall serve residents living no farther than one half (½) mile away.
- (4) Pocket Parks – A ¼-mile service area shall apply to a pocket park provided to fill a gap in an area that is unserved or underserved by neighborhood park land.

D. **EQUITABLE DISTRIBUTION OF OPEN SPACE** – Ensuring community access to plentiful open space is critical to PROS’ long-term vision for the parks, recreation and open space system. The city comprehensive plan also supports this philosophy by declaring open space as an essential physical feature for achieving the quality of life planned for the city. *Aurora Places* states:

- “... *protected open spaces support healthy living by connecting residents and visitors to Aurora’s natural amenities, while a robust and interconnected network of trail and bicycle ways serve commuters and recreational users alike.*”

The land dedication requirements of the city reflect the importance of open space to the community as well. Sixty-six percent (66%), or two-thirds, of the acreage required to be dedicated for park, recreation and open space purposes is intended for open space objectives. To advance these city policies, special emphasis shall be placed on open space during the design of new development so that it is geographically-distributed in a manner that all residents will have reasonably equal access.

Key principles for achieving equity in the availability of open space are as follows:

- (1) Plan for Cohesiveness – Create a cohesive park and open space system that physically links sites together by means of continuous ribbons of green space (i.e., greenways and greenbelts) woven into developed areas, which will maximize the ability of residents to access the system close to their homes:
 - (a) Rely upon major greenways and smaller connector greenbelts which punctuate development and become focal points and amenities.
 - (b) Aim to create strong corridors that help establish identity, form and continuity for the larger open space network beyond a development’s boundaries. Look beyond the immediate development site to understand its context within the area and its relationship to surrounding land uses, both existing and planned.
 - (c) Opportunities to contribute to the expansion of or fill a gap in a greenway/greenbelt should be a higher priority than satisfying open space

dedication requirements in other ways, unless there are significant natural resources associated with the development site which warrant or require protection, in which case that should take precedence.

- (i) The preservation of natural resources can and should be effectively incorporated into greenways.
 - (ii) Maintain or improve a site's natural resource values.
 - (iii) Capitalize on opportunities to enhance land along drainageways for habitat diversity and compatible recreation use.
 - (iv) Restore degraded lands.
 - (v) Introduce naturalized areas to expand environmental value and benefit.
- (2) Make Open Space Accessible via Trails – Provide an integrated bicycle and pedestrian network to enhance connectivity among open space areas (as well as parks and other key destinations) for both recreation and transportation benefit:
- (a) Focus on providing independent trails rather than shared sidewalk conditions.
 - (b) Supplement conventional greenways and greenbelts with wide landscape buffers and a meandering trail/sidewalk parallel to select streets as park-like spaces for bicycle/pedestrian comfort and mobility and as an upgrade to a traditional sidewalk.
 - (c) Minimize interruptions in the continuity of trails caused by at-grade street crossings, particularly for regional trails.
- (3) Distribution of Open Space – Distributed acreage achieves more for making land accessible for all residents of a development than does centralizing the acreage in one or two main areas:
- (a) Open space shall be distributed throughout a development such that no specific area contains the bulk of the dedicated acreage, unless PROS agrees that site characteristics or development design objectives warrant disproportionate allocation of the open space.
 - (b) The required open space land dedication acreage shall be distributed to the extent that, at a minimum, the percentage equivalent to the proportion of the overall development devoted to residential use must be interspersed among and between the residential areas.
- E. **FILLING SERVICE GAPS** – The principles presented in paragraph D above, in conjunction with the service area guidelines presented in paragraph C of this Section 3.7, establish that where gaps in the park and open space system exist, they shall be corrected by the addition of such amenities. PROS staff may, at their sole discretion, require the provision of a specific facility to meet the minimum service area requirements and needs of residents proposed with new development.

3.8 LAND DEDICATION CRITERIA

Certain types of land and land uses are listed in this section according to whether they are either permitted or prohibited for receiving land dedication credit.

A. PERMITTED FOR LAND DEDICATION:

- (1) Acreage occupied by significant natural resources, such as:
 - High points.
 - View corridors.
 - Black Forest and other wooded areas.
 - Native prairie habitat.
 - Special plant and animal species.
 - Riparian corridors and floodplain ecosystems in accordance with the provisions of the next subsection titled Floodplain.

Commentary: Developers are encouraged to protect and conserve these features to the greatest degree possible. These resources should be recognized on plans and adequate land should be set aside to preserve the area with buffers from adjacent uses.
- (2) Floodplain – Acreage that is regulated as a 100-year floodplain or within the 100-year water surface elevation as identified in an applicable city-approved drainage master plan or approved drainage study may receive credit toward the open space land dedication requirement, but shall not be eligible to satisfy neighborhood park or community park land dedication requirements. Up to but not exceeding fifty percent (50%) of the total open space land dedication requirement of a development may be satisfied by floodplain, provided the following additional criteria are met:
 - Mile High Flood District (MHFD) Funding – Floodplain land receiving credit also shall be deemed eligible for maintenance assistance through MHFD’s Maintenance Eligibility Program.
 - Conservation Value – In support of the land dedication planning principles presented in Section 3.7.B(2), the floodplain land shall also be designed, constructed, and managed to protect or enhance conservation values by preserving existing or creating new naturalized floodplain ecosystem habitat.
 - (a) **Existing Floodplain** – Open space dedication acreage that encompasses a significant natural ecosystem associated with an existing floodplain shall:
 - (i) Minimize the encroachment of infrastructure, such as utilities and streets, within the natural floodplain.
 - (ii) Maximize the continuity of the riparian corridor and ecosystem.
 - (iii) Accommodate appropriate public access to offer recreational value.
 - (b) **New Naturalized Floodplain** – Open space dedication acreage within man-made floodplain channels shall:
 - (i) Maximize consistency with MHFD design criteria for high functioning, low maintenance streams.

- (ii) Incorporate appropriate plant material sufficient to provide stream water quality benefits.
 - (iii) Advance the long-term provision of suitable habitat for wildlife.
 - (iv) Accommodate appropriate public access to offer recreational value.
- (3) Acreage for the continuation of and connections to the city's trail network.
Commentary: Developers are encouraged to provide for a contiguous open space system through new development and that trails, particularly regional trails at a minimum width of seventy feet (70'), be provided for trail user safety and comfort. All trails characterized as a regional corridor shall be not less than 70' wide in order to qualify as dedicated open space.
- (4) Acreage that is explicitly mapped or described in a PROS master plan for a future park or open space area to help fill a service area gap or meet a critical need.
Commentary: Developers are encouraged to follow the recommendations of PROS planning initiatives and to help implement such plans when applicable. PROS staff shall confirm whether a recommendation is still valid and relevant should the need arise for such a determination.
- (5) Acreage containing all or part of a storm drainage retention or detention system may be counted toward community park or open space acreage dedication if these additional following criteria are met:
 - (a) The lands shall offer open space benefit by providing significant recreational, conservation and/or educational value.
 - (b) The entire area receiving credit shall have twenty-four (24) hour recovery from stormwater inundating the pond/basin.
- (6) Acreage upon which a community recreation center or aquatic facility is located within a community park may be counted toward community park acreage if these additional criteria are met:
 - (a) The center/facility shall be publicly-accessible.
 - (b) The lands occupied by the center/facility shall be above and beyond the required forty (40) acre minimum size for a community park.

B. PROHIBITED FOR LAND DEDICATION:

- (1) Acreage devoted to stormwater detention and retention, except land that complies with Section 3.8.A(6) above.
- (2) Water quality facilities. (Dedicated lands shall be outside of all water quality facilities.)
- (3) Acreage within three hundred and fifty feet (350') from an oil and gas well pad, said distance shall be measured from the perimeter of the oil and gas site or property line or the designated boundary of the reclaimed pad site.

- (4) Lands in excess of four-to-one (4:1) slope used to transition grades between city and non-city lands. The maximum distance of a sustained slope may, at the discretion of PROS, be limited. The decision to limit how far a slope may extend longitudinally will be based on an analysis of the ability to provide the required programmatic elements of the park or open space and the collective impact that all surrounding slopes will have on the public use and function of the site. Retaining walls or other treatments may be required to reduce the impacts of sloped areas.
- (5) Lands that are already encumbered from development such as deed restricted areas; lands protected by conservation easements; utility easements for gas pipelines, overhead electric transmission lines, and waterlines which restrict the installation of plant material and public use amenities; the E-470 Multi-Use Easement; etc.
- (6) Neighborhood entry features, monumentation and signage.
- (7) Street rights-of-way and streetscapes.
- (8) Medians and traffic-related “eyebrows,” except those that satisfy mini park criteria in accordance with Section 6.12 of this manual.
- (9) Golf courses.
- (10) Private clubhouses, community centers and recreation centers (including associated parking lots).
- (11) Swimming pools and other restricted access facilities.

SECTION 4

PARK DEVELOPMENT FEES

4.1 PARK DEVELOPMENT FEE REQUIREMENTS

In order for park land to serve its intended function and fully satisfy the needs of the residents, Section 146-5.3.20 of the City Code (refer to Appendix B) requires the construction of facilities upon dedicated land.

- A. If developers do not build a neighborhood park or community park (or both) within their development, they must pay a park development fee so that the city can construct the required facilities.
- B. The fee is based upon unmet park facility needs and the land dedication requirements of a development. Neighborhood and/or community park development fees are equal to the park land acreage to be developed by PROS multiplied by the city's average cost of recent park development.
- C. Fees are currently calculated using average construction costs of \$176,794 per acre for neighborhood park facilities and \$177,679 per acre for community park facilities. These per-acre costs are updated by the city annually or as needed. Construction costs are updated based on the Construction Cost Index (CCI; computed by the *Engineering News Record*) for the Denver metro area if new city cost data is not available. The CCI is a type of inflationary index that measures how much it costs to undertake a construction project compared to what it was in a chosen base year.
- D. Fees calculated in accordance with City Code Section 146-5.3.20 are levied and assessed upon the following types of development:
 - (1) Lands annexed to the city after December 31, 1984.
 - (2) All rezoning and changes in land use occurring after August, 2001.
 - (3) Lands with annexation agreements prior to August, 2001 which do not indicate a per-unit Park Development Fee cost or where no annexation agreement exists.

Note: Fees collected from developments for lands annexed to the city prior to August, 2001 are generally based on a per-unit cost of \$300, provided that such dollar amount is established within the applicable annexation agreement.
- E. In some cases, the city may impose an exaction as a monetary payment equal to the park development fee. The exaction may be applicable to properties that were annexed before December 31, 1984 and represent a new and significant burden on the parks, recreation and open space system. The exaction shall be used to provide recreation facilities required to the extent the demand or need for such facilities is created by the proposed development in order for the city to provide public facilities or services at a level roughly proportional to those received by other residents of the

city, to the extent authorized by the constitution or laws of the federal government or the state of Colorado, including without limitation the powers granted to home rule municipalities in Article XX of the Colorado Constitution.

4.2 FEE CALCULATION METHODOLOGY

Below and on the next page is the methodology used to calculate park development fees. The methodology and hypothetical example are continuations of the processes described in the land dedication portion of this manual (refer to Section 3).

Step 5: (If none or not enough acreage is developed on-site to satisfy the requirement of either category of park land, then a park development fee shall be provided for the balance. This step adjusts the land dedication acreages to account for qualifying developed park land.) Adjust the acreages from Step 2 if qualifying park and open space land will be developed on-site as part of the project.

A. Required NP Acreage – # of acres of NP acreage developed on-site = Adjusted NP Acreage

B. Required CP Acreage – # of acres of CP acreage developed on-site = Adjusted CP Acreage

Note: If the City has agreed to accept responsibility to construct a park(s) upon land dedicated for park purposes, a per-acre cost shall be collected for the acreage to be constructed. In these cases, the dedicated park acreage to be developed by the city should not be subtracted in this Step 5. Only park land that will be both dedicated **and** developed by the developer should be subtracted.

Step 6: Multiply the adjusted acreages from Step 5 by the city-determined costs for developing each respective category of park land. Then add the results together to arrive at a total development fee.

A. Adjusted NP Acreage from Step 5.A X NP Development Cost = NP Development Fee

B. Adjusted CP Acreage from Step 5.B X CP Development Cost = CP Development Fee

C. NP Development Fee + CP Development Fee = Park Development Fee

Step 7: The total fee is then apportioned to the type of unit for which building permits will be issued.

A. Neighborhood Park Development Fee adjustment, if necessary:

1) Required NP Acreage – # of acres of NP acreage developed on-site = Adjusted NP Acreage

2) Adjusted NP Acreage X NP Development Cost = NP Development Fee

B. Community Park Development Fee adjustment, if necessary:

1) Required CP Acreage – # of acres of CP acreage developed on-site = Adjusted CP Acreage

2) Adjusted CP Acreage X CP Development Cost = CP Development Fee

C. The Park Development Fee for the entire development is computed:

1) NP Development Fee + CP Development Fee = Park Development Fee

D. For purposes of calculating how much money should be collected at the time of building permit issuance, the Park Development Fee is then apportioned to the type of dwelling unit(s) that will be built in the development:

Single Family (SF) Dwelling Units, if any:

1) (NP Development Fee X percentage of projected SF population) / # of SF units = NP Fee Share

2) (CP Development Fee X percentage of projected SF population) / # of SF units = CP Fee Share

3) NP Fee Share + CP Fee Share = SF Per Unit Fee

Multi-Family (MF) Dwelling Units, if any:

1) (NP Development Fee X percentage of projected MF population) / # of MF units = NP Fee Share

2) (CP Development Fee X percentage of projected MF population) / # of MF units = CP Fee Share

3) NP Fee Share + CP Fee Share = MF Per Unit Fee

Transit Station Area (TSA) Dwelling Units, if any:

1) (NP Development Fee X percentage of projected TSA population) / # of TSA units = NP Fee Share

2) (CP Development Fee X percentage of projected TSA population) / # of TSA units = CP Fee Share

3) NP Fee Share + CP Fee Share = TSA Per Unit Fee

Active Adult Community (AAC) Dwelling Units, if any:

1) (NP Development Fee X percentage of projected AAC population) / # of AAC units = NP Fee Share

2) (CP Development Fee X percentage of projected AAC population) / # of AAC units = CP Fee Share

3) NP Fee Share + CP Fee Share = AAC Per Unit Fee

Step 5:

- A. 0.80 acres – 0.0 acres = 0.80 acres
- B. 0.29 acres – 0.0 acres = 0.29 acres

Note: This example assumes that an on-site park will not be constructed by the developer or the city because the required acreages are too small to satisfy minimum site size requirements. Instead, the city will collect the fees to construct parks at other locations to serve the residents.

Step 6:

- A. 0.80 acres **[or 0.7950 acres]** X \$176,794 per acre = \$140,551.23 NP Development Fee
- B. 0.29 acres **[or 0.2915 acres]** X \$177,679 per acre = \$51,793.43 CP Development Fee
- C. \$140,551.23 + \$51,793.43 = \$192,344.66 Park Development Fee

Note: To maintain a consistent per-unit cost for all developers across-the-board (and to simplify account tracking), the Park Development Fees in Step 6 are based on park land acreage needs that are not rounded off.

Step 7:

- A. Apportioning the total fee to the type of unit for which building permits will be issued results in the following per-unit fees:
 - Neighborhood Park Development Fees -- \$1,405.51 per single family unit
 - Community Park Development Fees -- \$517.93 per single family unit

4.3 FEE TRACKING

Park development fees are used to provide park and open space facilities to serve the future residents of the development from which they are collected. Fees are deposited into a special account and reserved solely for use by PROS. Using the city’s accounting software program, PROS staff is able to identify the geographic area from which the monies were received. Staff ultimately requests approval from City Council to appropriate the money, in its entirety or in part, to fund future capital park projects that service the development as they are budgeted and programmed.

4.4 OTHER PROS-RELATED FEES

Other fees paid to PROS as a result of development review and approval processes may be required based on the unique circumstances of a development project.

- A. **CAPITAL IMPACT FEES** – For the purpose of defraying the projected impacts on capital facilities of the city caused by proposed development, the city collects Capital Impact Fees in accordance with Section 146-5.3.17 of the City Code (refer to Appendix C). Fees for large urban, special use and regional parks as well as for recreation purposes vary according to the type of proposed residential unit. For the year 2020, fees are as follows:

<u>Type of Dwelling Unit</u>	<u>Large Urban, Special Use, & Regional Parks</u>	<u>Recreation Purposes</u>
Single Family Detached Unit	\$629.51	\$371.66
Single Family Attached Unit	\$483.84	\$272.06
Multi-Family Dwelling Unit	\$451.01	\$268.42

Fees are collected at time of building permit issuance on a per-unit basis. PROS staff requests approval from City Council to appropriate capital impact fee money, as needed, to fund qualified capital improvement projects as they are budgeted and programmed.

- B. **GOLF FEES** – In accordance with the golf course development agreement executed for the Murphy Creek Golf Course, lot premiums to help recover the cost to construct the golf course and related facilities are paid to the city prior to issuance of a certificate of occupancy for all residential units within the development. The premium amount varies based on the type of residential unit constructed:
- \$600.00 per Single Family dwelling unit.
 - \$400.00 per Multi-Family dwelling unit.
- C. **TREE PLANTING FEES** – For the purpose of planting and maintaining street trees, PROS collects prior to issuance of a building permit a tree planting fee from developers on a per-lot basis. In accordance with Section 142-31 of City Code, this fee is calculated based on the total linear distance that each lot abuts public street rights-of-way. The total linear footage is then multiplied by a unit cost that varies according to the type of proposed land use. The unit costs, which are adjusted annually, are as follows for the year 2020:
- \$6.95 per linear foot for a single family lot.
 - \$3.45 per linear foot for a multi-family lot, excluding any distance abutting minor and major arterial streets.
 - \$3.45 per linear foot for a commercial lot, excluding any distance abutting minor and major arterial streets.
- D. **TREE MITIGATION** – In accordance with Section 4.7.7 of the City Code, developers are required to comply with the tree preservation, relocation and mitigation requirements found in the city’s adopted “Policy on Preservation of Existing Trees.” Depending on the circumstances of a proposed development project, a monetary payment which is the appraised value of an existing tree that will be removed (if not being replaced on-site) may be required. Tree mitigation monies are collected prior to site plan recordation and deposited into the community tree fund for purposes of tree planting and maintenance. Consult with the City Forester in PROS to learn more about the details of the city policy, including the guidelines for determining the value of lost trees, if you are contemplating tree removal without on-site replacement.
- E. **PLAN REVIEW FEES** – Developers that choose to construct a neighborhood park, a developed median or any other physical asset that will become the maintenance responsibility of PROS may need to prepare special plans, such as a park master plan or design and construction drawings, which are submitted to PROS for review and approval independent from other processes required to proceed to construction. The time spent by staff to review the plans to ensure that the design and construction conforms to PROS standards, details and specifications is recoverable as a service fee which is calculated on a per-sheet cost basis:
- The fee for 2020 is \$259.00 per sheet.

SECTION 5

FACILITY AND RESOURCE PROTECTION

5.1 GENERAL

When development occurs in the city, it may impact the park, recreation and open space system in ways other than necessitating additional land and facilities to serve new residents. Resource protection and mitigation measures may be required if a development project proposes to disturb PROS' facilities and resources or to develop adjacent to or near them.

5.2 CITY CHARTER AND CITY CODE PROTECTIONS

The City Charter and City Code afford protections to land that is intended to be used for publicly-accessible recreation and open space uses:

- A. **CITY CHARTER** – City Charter restricts the sale or conveyance of lands granted to, or purchased for use and used by the city for park purposes, without a majority vote of the registered electors at a special or regular municipal election. The charter does not provide any other specific protections to city parks and open spaces except to authorize PROS to establish rules and regulations as may be necessary to control their use (refer to Section 2-371).
- B. **CITY CODE** – Article 146 of City Code, also referred to as the Unified Development Ordinance (UDO), sets forth land use, subdivision, and development regulations applicable to all properties throughout the city. It is the UDO which authorizes PROS' land dedication requirements and park development fees presented earlier in Sections 3 and 4 of this manual, but it also establishes policies for the preservation and protection of parks, recreation and open space as an essential land use in the city:
 - (1) Parks and Open Space (POS) District – The POS zone district recognizes the necessity of existing park and open space lands as areas which benefit public health, safety and welfare. The intent of this base zone district is to map said areas and to perpetuate them as a special purpose land use into the future.
 - (2) City Parks Overlay (CPO) District – This overlay district supplements the POS base district by serving as a mechanism which further recognizes and protects land that was acquired by the city for public park and recreation purposes. The district places restrictions on the conveyance and conversion of the land to a non-park use as well as limitations on future improvements and operations within such designated areas.
 - (3) Natural Areas Overlay (NAO) District – Like the CPO District, this overlay district also supplements the POS base district, but it further recognizes and protects land that was acquired by the city to serve as natural and conservation

areas and preserves. The district restricts future use and development to that which is compatible with conservation easement protections, approved master plans and resource management goals and objectives.

- (4) Special Landscape Buffer – Section 146-4.7.5.H of the UDO requires special landscape buffers adjacent to public parks, open space and trails. The purpose of these development standards is to provide a setback from the edge of public properties within which plant material is planted to help buffer and screen adjacent development, thereby improving the landscape aesthetic and increasing the compatibility between different land uses. Minimum plant material quantities for the landscape are specified and PROS has the authority to approve the planting plan, including the ability to require that a buffer be treated as a native landscape if deemed appropriate to complement an adjoining public use area.
- (5) Fence and Wall Regulations – Fencing and wall standards for land uses adjacent to public parks, open space and trails are found in Section 146-4.7.9.K of the UDO. The purpose of these requirements is to further screen adjacent uses and to provide safety and security measures for the protection of the public as well as the natural resources within the public property.

5.3 PROTECTED SITES

Additional site protections above and beyond city charter and code requirements may need to be considered during development. Certain PROS properties are encumbered by instruments that were executed to protect sites and resources and to regulate use and development. Research into real property records is advised to determine if any of the following instruments could pose limitations on proposed changes or impacts to PROS property:

- A. **CONSERVATION EASEMENTS** – A conservation easement is a legal agreement that places restrictions on the use of property in perpetuity to protect the conservable values that make a site special and worthy of preservation. The easement becomes a recorded instrument which is held by a conservation-minded entity who monitors the property to ensure the terms of the easement are upheld. The city holds title to many properties that are encumbered by an easement.
- B. **DEED RESTRICTIONS** – Before taking ownership of property, conditions agreeable to the city may have been placed within a deed. City park and open space properties could include restrictive language in their deeds or perhaps on the subdivision plats which dedicated the land to the city.
- C. **COVENANTS, CONDITIONS & RESTRICTIONS** – Covenants, Conditions and Restrictions (CCRs) is another type of legally binding document that runs with the land and places limitations on the use of a property.
- D. **FUNDING-RELATED RESTRICTIONS** – The city often leverages outside funding to help acquire land and improve parks, open space and trails. Such funding can involve special conditions that then apply to the property, including conversion clauses that restrict what the city can later do at the site without having to pay back

the monies received. Some grant programs require sites be forever open for public park purposes, thereby prohibiting lands and facilities from being converted to non-park uses.

5.4 STEWARDSHIP

As land manager of the city's parks and open spaces, PROS must be a responsible steward by monitoring properties and safeguarding them from encroachments and degradation. Without a defined policy regarding use and protection of the lands, the parks and open spaces could be at risk from misuse.

Below are standards outlining permitted uses and activities as well as access constraints necessary to manage park and open space properties for continued public benefit and to protect sensitive resources as well as the public investment already committed to those sites.

A. **ENCROACHMENT / OCCUPANCY** – In general, park and open space lands and facilities owned by the city shall not be encroached or trespassed upon for any unauthorized purposes. An unauthorized purpose shall be any use or activity that PROS had not formally been requested to consider and subsequently approved. PROS staff will review written requests accompanied by related graphic materials submitted by parties that wish to occupy a portion of a park or open space for any purpose, be it temporary or long-term in nature. A decision regarding such requests will be made taking into consideration factors relative to the proposed use/activity, which include but are not limited to the following:

- (1) Probable public health, safety and welfare impacts.
- (2) Probable impacts to the park character and any effects on facility usage.
- (3) Probable impacts to natural resources.
- (4) Potential to restore the park or natural area to its original condition.
- (5) Potential to improve the property and expand public use.
- (6) Feasible alternatives to the proposal.

PROS may authorize uses and activities with conditions of approval deemed appropriate to reasonably address concerns and opportunities associated with disturbance and occupancy of the lands. Some examples of conditions that might be imposed or negotiated include:

- (1) Land restoration and enhancement.
- (2) Site improvements.
- (3) Monetary compensation.

Encroachment into park and open space areas for utilities shall be avoided. Corridors for sanitary sewer, water lines, etc. should be located within residential and other private properties served by the utilities, to the greatest extent possible, rather than be designed to fall within city property. Site disturbance for utility installation and future maintenance and repair is an intrusion into public use areas and natural areas. For these same reasons, all utilities should also be designed so that access to the easement corridor can be achieved without having to pass through city property, if possible.

- B. **ENCROACHABLE AREAS** – The city has established policy regarding encroachment of private property interests onto City of Aurora easements, rights-of-way, and property. The Real Property Services Division of the Public Works Department administers the policy by processing requests and issuing license agreements that grant permission to cross, use, or occupy city property. Agreements typically grant temporary permission for the encroachment and are revocable at the city’s election:

- (1) License Agreements – License agreement requests that affect city parks and open space real property assets are reviewed by PROS to ensure the encroachment will be compatible with and will not adversely impact its resources or the public’s use and enjoyment of or access to said properties. PROS is a signatory to such license agreements, thereby authorizing encroachments that appear to be reasonably consistent with applicable standards and will not impede the use or function of the property or cause danger to the health, safety, and welfare of the general public.

Where a party has encroached into parks and open space properties without authorization, PROS shall seek to eliminate the encroachment, restore the affected area, and/or process a license agreement that covers the encroachment to the extent possible, provided PROS finds the encroachment acceptable and the licensee can satisfy all requirements and special conditions that may be imposed.

- C. **TEMPORARY ACCESS** – PROS may grant permission to an entity for temporary access and use of park and open space property provided the entity seeking this privilege agrees to adhere to PROS criteria, standards and specifications:

- (1) Access Agreements – Temporary access is granted using an Access Agreement which spells out the terms and conditions of the access and use. Plans showing the proposed activity requiring access must be submitted to PROS staff for review and approval and the agreement must be fully executed prior to commencement of any work. The entity must also protect the property to a degree satisfactory to PROS as the work is being performed and restore the land following completion of the work. PROS staff shall be on site to observe the work and ensure compliance with all requirements.

- D. **LANDSCAPED MEDIANS** – In order to accommodate access needs for future developments and modifications to travel patterns within public street rights-of-way, PROS will permit reasonable impacts to existing landscaped medians that it maintains. When an existing landscaped median is impacted by a development

proposal to the degree that existing hardscape, landscape or irrigation must be altered and/or removed, developers shall work with PROS staff to ensure that the resulting median improvements are attractive, functional and safe:

- (1) Accurate survey information of existing conditions shall be provided for PROS to decide how the median should be retrofitted to establish good function and form for the remainder.
- (2) Median retrofits shall be designed to PROS standards.
- (3) Developers shall be required to pay all associated expenses to restore the median to PROS standards.

E. **GENERAL LAND MANAGEMENT ISSUES** – Growth and development adjacent to and near city parks and open spaces poses a potential concern to resource protection and public use. To protect lands currently owned as well as those expected to be dedicated to the city in the future, some basic practices may be required:

- (1) Development Inspection – When a development project involves work adjacent to or within a parks or open space property or landscaped median or will otherwise affect the infrastructure, resources, and use of such property or median, the development activity shall be supervised by PROS construction inspection staff. The presence of PROS at a development site shall be in addition to and not a substitute for any Public Improvement Inspections staff inspections and approvals required by the city.
 - (a) **Development Notes** – The following general notes shall be included on civil CDs to serve as general notification of the need to coordinate with PROS to ensure compliance with PROS requirements:

Parks, Recreation & Open Space

- *Prior to commencing work within Parks, Recreation & Open Space (PROS) properties or landscaped medians or upon land, including rights-of-way, adjacent to PROS properties or medians, contact a PROS Department construction inspector to fully review existing conditions, requirements, and procedures.*
- *All work within PROS properties or landscaped medians or upon land, including rights-of-way, adjacent to PROS properties or medians shall comply with requirements in the PROS Dedication and Development Criteria Manual.*
- *Approval from or acceptance by the Public Improvements Inspector does not constitute approval or acceptance by the PROS Department. Contractor shall have all work within PROS properties or landscaped medians or upon land, including rights-of-way, adjacent to PROS properties or medians inspected by the PROS Department construction inspectors for compliance with applicable Department requirements. Written approval and acceptance from the PROS Department will be required to verify compliance.*

- (2) Vegetation Management – During and after construction activity, re-vegetate adjacent properties using appropriate seed mixes; plant native trees, shrubs and grasses; and control noxious weeds through weed management. These measures should discourage the spread of weeds and noxious plants into parks and open spaces.
- (3) Access Control:
- (a) Install fencing along the common boundary or inside adjacent private properties. Fencing types may include temporary construction fence, t-post and wire fence, post and cable fence, post and 3-rail open space fence with pet mesh or other approved installations (refer to Appendices D and J). The purpose of these measures is to prohibit vehicular and public access except at designated access points, which shall also be designed with gates and/or bollards (installed per PROS standard details or approved construction drawings) to restrict vehicular access. Post and rail fencing with pet mesh shall be provided along the perimeter of all residential lots to control domestic animals, such as dogs and cats, from accessing wildlife habitats and natural areas.
 - (b) Gates or other movable openings shall not be installed within fences to facilitate access from backyards or adjacent private properties into park and open space land, except in cases where PROS has formally reviewed and approved such access points. All decisions regarding requests for proposed accesses, including their specific location and gate type, shall be made taking into consideration factors relative to the probable impacts said points of access may have on public health, safety and welfare as well as any impacts to city property usage and natural resources.
- (4) Natural Resource Management – The preservation and protection of habitat for plants and animals is an important role served by lands that are managed by PROS. Certain measures may be required of development to protect such natural resources:
- (a) The Director of PROS may require, at his/her sole discretion, additional buffer specifications beyond the special landscape buffer provisions in City Code to further protect adjacent habitats or species.
 - (b) Prairie dog treatment and control, possibly including the installation of a prairie dog fence, is required prior to any earth disturbance on development sites adjacent to park and open space areas to prevent the animal population from migrating onto park and open space property. The standard details for prairie dog fencing can be found in Appendix J.
 - (c) All migratory birds (including eggs, nests, and feathers) are fully protected. Under the Migratory Bird Treaty Act of 1918, taking, killing or possessing migratory birds is unlawful. “Take” includes destruction or disturbance of nests and eggs. Birds protected under this Act include all migratory birds from hummingbirds and owls to geese and hawks. For this reason, it is essential to limit disturbance to natural habitat during breeding season, which varies by habitat and species.

- (d) Seasonal restrictions may apply for projects which are proposing construction near known raptor nest locations. This includes restricting disturbance within a one-half (½) mile radius of known nests between October 15 through July 31. Please refer to cpw.state.co.us for more information.
- (5) Environmental Study – To safeguard existing city parks and open space resources, a developer may be required to submit an environmental study to identify and describe how city property would be impacted by a proposed development. The study should describe the location, design, scale, size and area of influence of the proposed construction activity and provide a thorough site analysis with appropriate mapping and text that describes the following typical components:
 - (a) Floodplains and stormwater flows.
 - (b) Wetlands and waters of the United States.
 - (c) Threatened and endangered plant and animal species.
 - (d) Air quality.
 - (e) Existing and predicted noise levels.
 - (f) Historical and archeological sites.
 - (g) Viewshed protection, in some cases.

If PROS' review of the study finds that potential impacts are significant and unacceptable, development alternatives may need to be explored to avoid, minimize or mitigate adverse impacts.

F. TREE PROTECTIONS – Trees within the city are protected under the provisions of sections of the City Code. Excerpts from these regulations are included in Appendix G.

- (1) Policy on Preservation of Existing Trees – Existing healthy trees that satisfy certain size and locational criteria shall be preserved and protected during the development process. Trees may either be preserved in the present location, relocated on-site or within a public park or open space, or mitigated by equal replacement of tree caliper inches or the payment of value of caliper lost to the city's tree planting fund.
- (2) Black Forest Ordinance – The Black Forest is a unique ecosystem of Ponderosa Pines and Gambel Oaks that extends into the southern part of the city. The ordinance requires preservation, relocation or replacement/mitigation of these pine and oak trees of a certain size. The replacement option generally is satisfied by replanting tree loss at a caliper ratio of one-to-one (1:1).

G. **TELECOM & WIRELESS COMMUNICATION FACILITIES** – Facilities which provide wireless communication services to the public can have direct and indirect impacts on park and open space properties. Such facilities should be located where they will have the least potential to result in negative effects to the system, operations and customers. Siting considerations for the protection of the interests of PROS vary based on the type of facility:

(1) Telecom Facilities – These are large, visible facilities mounted on towers, poles and buildings and can include a freestanding structure which houses related equipment. PROS does not support accommodating these facilities within parks and open space areas for several reasons:

- The facilities would adversely impact aesthetics of the site and the visitor experience.
- The public perception of a cell tower adjacent to a park (i.e., RF exposure concerns) could dissuade visitation and recreation activity, which is contrary to the purpose of a public park.
- Transmission towers/poles and associated equipment buildings would take away available space for park/open space related uses, activities, and facilities.
- The need for round-the-clock access to the facilities could cause security issues and potential conflicts with programming and maintenance operations as well as visitor use.
- Such use would represent a conversion of park/open space land to non-public use, which is precluded by City Charter and perhaps also by use restrictions applicable to the site.

Commentary: Any proposal to locate a telecom facility in a park would trigger a master plan amendment process under which the following factors would need to be thoroughly vetted with public input:

- Significant change in the character of the park use.
- Intensification of external effects on adjacent property.
- Significant visual impact.

PROS does not support locating telecom facilities adjacent to public parks and open space areas for the top two reasons listed above. Generally, telecom facilities are not considered by PROS to be a compatible use, whether surrounded by park/open space land or as a neighboring land use.

(2) Small Cell Wireless Facilities – These are small, inconspicuous facilities where antennas and related equipment are located inside enclosures mounted on light poles, utility poles and traffic signals within public rights-of-way. The concealed nature of these facilities, coupled with their placement and accessibility within streets, makes them relatively compatible with parks and open space.

To protect PROS's interests, the following issues should be taken into consideration during siting and licensing decisions for small cell wireless installations:

- If a proposed installation requires excavation or any ground disturbance within a property or right-of-way where there is a potential to disturb known or suspected environmental pollutants or contaminants, an alternative location should be sought to protect public health and safety.

- If a proposed installation requires significant disturbance to existing street trees to the extent that the overall health of the trees could be jeopardized, an alternative location should be sought.
- If a proposed installation results in placement of a new pole/post which could impede access, compromise public safety or reduce the effectiveness of maintenance operations, an alternative location should be sought.

In the event any of the above or similar circumstances are encountered, PROS will cooperate to the maximum extent practicable to shift the pole location to eliminate the conflict; otherwise, the opposite side of the street should be explored as an alternative location.

H. OIL & GAS FACILITIES

- (1) **Buffering & Setbacks** – City Code requires oil and gas well sites and facilities to have a twenty-five feet (25') wide landscape buffer when adjacent to a park or open space. This buffer may provide a small amount of visual relief, however it will do very little to effectively mitigate for other impacts and hazards associated with such an industrial land use:
 - (a) **Required Setback** – Due to the perceived incompatibility of oil and gas operations, particularly during certain phases of operation, these uses shall not be located closer than three hundred and fifty feet (350') to an existing or proposed public park or open space area. This setback distance is consistent with the requirement set by the Colorado Oil and Gas Conservation Commission (COGCC) for what they define as a “Designated Outside Activity Area” and shall be measured from the edge of the oil and gas facility to the park or open space boundary.
- (2) **Oil & Gas Permit Application Review** – Applications for oil & gas facilities are reviewed by PROS staff to ensure compliance with applicable criteria in this manual as well as the city's Oil & Gas Manual. Two components of applications are reviewed, if applicable to the oil & gas location and proposed project:
 - (a) **Wildlife Impact Mitigation Plan** – Proposed operators of an oil & gas location/project are required to conduct research to conclude whether it is located in a significant wildlife habitat, as defined by the State Division of Wildlife, or in a natural area or open space, as designated by the city. Colorado Parks and Wildlife and PROS are consulted to make these determinations and, if applicable, a wildlife impact mitigation plan that recommends site-specific and cumulative impact mitigation procedures is then submitted for review.
 - (b) **Noxious Weed Control Plan** – Proposed operators are required to submit a noxious weed control plan which provides text, maps and other descriptive material to define the proposed approach and practices for the control and management of noxious weeds as defined by State law. These plans are reviewed by Aurora Water and PROS.

THIS PAGE INTENTIONALLY LEFT BLANK

SECTION 6

DESIGN CRITERIA

6.1 GENERAL

This section of the manual describes design criteria governing the sites, facilities and improvements for Aurora's parks and open space system. The PROS classification system is explained first and then basic design principles for the system are presented. The remainder and bulk of this section is devoted to descriptions of the various components of the classification system accompanied by design standards and requirements for each, followed by criteria for standard site elements and specialized facilities.

6.2 PROS CLASSIFICATION SYSTEM

The classification system on the next page graphically depicts the framework that PROS relies upon to provide a well-balanced supply of park and open space opportunities, uses and facilities. Each type of physical asset within the classification system plays a unique role or purpose based, in part, on the asset's function, size, location, available facilities, environmental features and service area geography. The first tier of the classification system organizes assets into one of three categories to match the basic type of site that it is:

- A. **DEVELOPED PROPERTIES** – These assets are predominantly developed sites, meaning they are improved with facilities primarily for active recreation as well as perhaps passive recreation and typically include some degree of irrigation to sustain playfield turf areas and other parts of the landscape. All types of parks fit into this category as do city golf courses. Medians that have been improved along major arterial streets and which are an aesthetic and functional enhancement to the street are also in this category, regardless of whether the plant material is irrigated or not.

The nine (9) types of parks in Aurora are further organized in a hierarchical manner under the Developed Properties category to generally reflect the size of the park, the number of facilities offered, and the magnitude of the geographic area and population served. Generally, parks that serve large segments of the population tend to be proportionally large in size with a wide range of facilities while smaller parks with fewer facilities typically serve smaller geographic areas and populations. These simple parameters are used to place the park types in a relative order of functionality with the larger parks that serve a larger number of people toward the top of the list and the parks that get smaller and serve proportionately less people toward the bottom of the list:

- (1) Regional Parks.
- (2) Large Urban Parks.
- (3) Special Use Parks.
- (4) Community Parks.
- (5) District Parks.

- (6) Neighborhood Parks.
- (7) Pocket Parks.
- (8) Mini Parks.
- (9) Small Urban Parks.

Each park’s standing within the hierarchy is not necessarily a reflection of its importance relative to the other parks. Collectively, all parks work together to fulfill needs throughout the city, and those closest to the top are not more important than those at the bottom. On the contrary, although the “neighborhood park” classification is located near the bottom, it is a critical element of the parks system relied upon to satisfy residents’ fundamental recreation needs close to home.

As previously noted, golf courses and landscaped medians are classified as developed property assets managed by PROS although they are not considered parks. These assets are tacked to the bottom of the hierarchy bracket beneath traditional parks with no objective to imply that these sites are less important than those above.

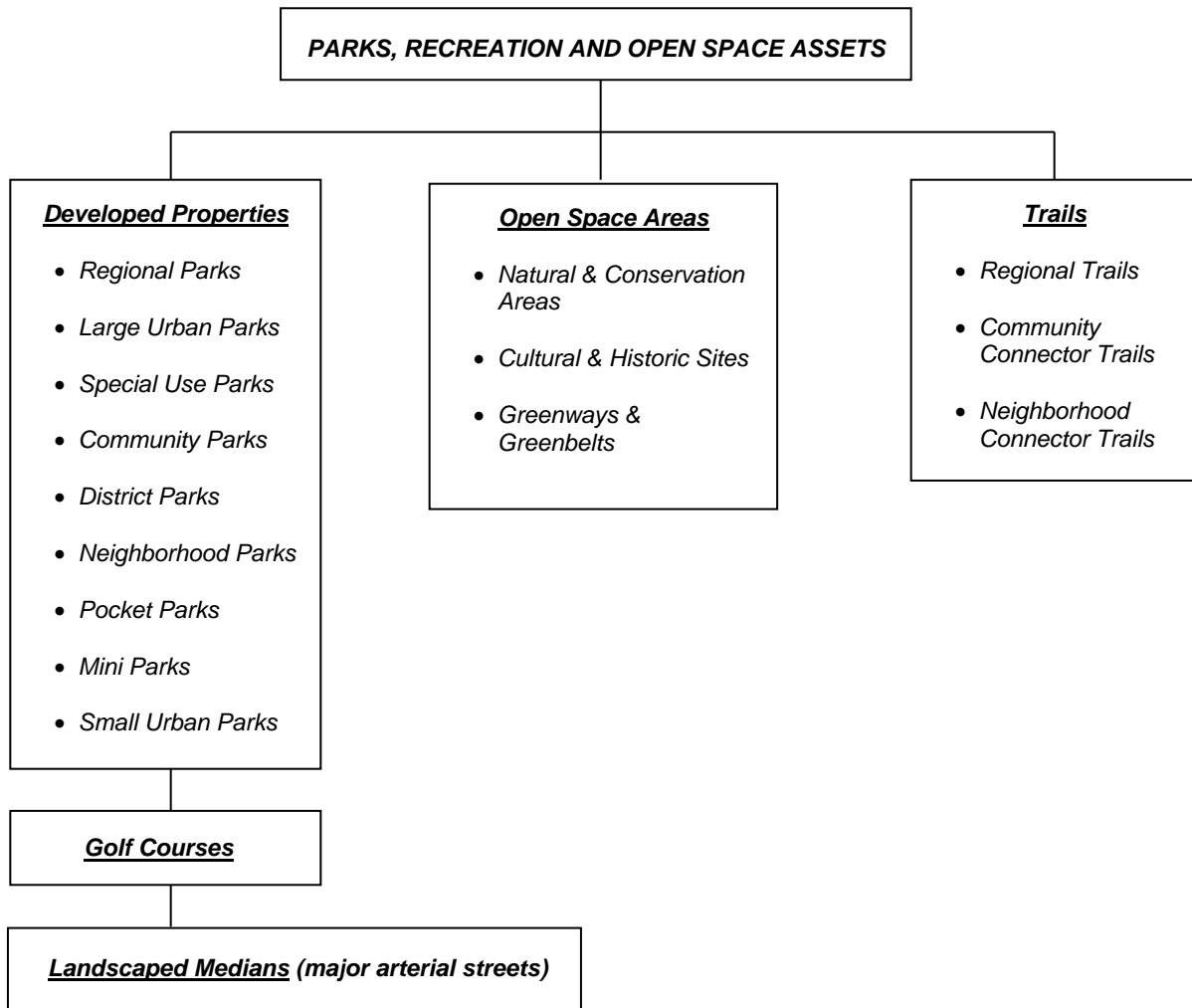

B. **OPEN SPACE AREAS** – Open space is land that is primarily unimproved, except for the inclusion of trails and limited passive recreation facilities or built features of cultural significance, and which is designated to be reserved for natural, environmental or historical reasons, such as to support natural systems, conserve habitat for plants and animals, preserve terrain features, retain scenic quality, interpret the past, teach an outdoor ethic, and provide the general population with quiet places away from development. Within this group of assets, there are three types of open space:

- (1) Natural & Conservation Areas.
- (2) Cultural & Historic Sites.
- (3) Greenways & Greenbelts.

C. **TRAILS** – Trails are pathways for people which accommodate pedestrians, bicyclists and, in some cases, equestrians. Trails are usually not completely independent assets, but rather are typically associated with parks and open space areas within which they are located or through which they pass. Trails most often coexist within greenways/greenbelts to form an interconnected network of green space which also doubles as a recreation and transportation system linking people to destinations throughout the city and to neighboring jurisdictions.

There are three types of trails. Each trail serves a distinct purpose by providing connections in a hierarchical manner based upon their length, the types and number of destinations that are connected, and the basic geographic area served. A simple way to categorize trails is to consider whether they serve a large regional need, a community-based need or a localized neighborhood need:

- (1) Regional Trails
- (2) Community Connector Trails
- (3) Neighborhood Connector Trails

Similar to the parks hierarchy, the classification system for trails is a tool used to characterize different trail types and not necessarily an indication of the importance of one type of trail over another.

6.3 DESIGN PRINCIPLES

PROS embraces overarching design principles for the parks, recreation and open space system. The following tenets shall be integrated into every design project:

A. **DESIGN COMPLIANCE FOR CITY OWNED AND MAINTAINED ASSETS:**

- (1) Ownership and maintenance responsibilities for sites, facilities and improvements to be constructed by developers shall be explicitly set forth in the applicable master plan for developments so that the appropriate design criteria can be applied at the time of site plan review.
- (2) All sites, facilities and improvements to be owned/maintained by PROS shall follow the design process outlined in Section 7 of this manual. All aspects of planning, design and construction must be thoroughly reviewed, inspected and approved by PROS staff to ensure that ownership and maintenance

responsibility can be accepted by the city based on compliance with city criteria and standards.

- (3) All sites, facilities and improvements to be owned/maintained by PROS shall comply with the standard design requirements, procedures, specifications and details as outlined in this manual, including applicable manuals prepared by other city departments, and City Code.
- (4) All sites, facilities and improvements to be owned/maintained by PROS shall incorporate PROS standard site furnishings and signage in order to reinforce the Aurora identity. Park and open space standard equipment referenced in Appendix F shall be used.

B. SAFETY:

- (1) Provide spaces and access routes with user safety in mind and which incorporate into their design adequate buffers from adjacent and nearby incompatible uses.
- (2) Parks, recreation facilities and open space areas shall be designed to provide adequate opportunity for visual surveillance.
- (3) All sites and facilities shall comply with all Americans with Disabilities Act Accessibility Guidelines (ADAAG), American Society for Testing and Materials (ASTM), Manual on Uniform Traffic Control Devices (MUTCD), and American Association of State Highway and Transportation Officials (AASHTO) requirements.
- (4) All sites and facilities shall comply with the most recent version of Public Works' *Roadway Design and Construction Specifications* and Aurora Water's *Standards and Specifications Regarding Water, Sanitary Sewer & Storm Drainage Infrastructure Standards and Specifications and Rules and Regulations regarding Stormwater Discharges Associated with Construction Activities*.

C. PRESERVATION & IMPACT MINIMIZATION:

- (1) Impacts upon natural ecosystems, wildlife corridors and significant geologic features shall be minimized.
- (2) New development shall be planned, where reasonable, to protect water quality, wildlife habitat, significant natural vegetation and features to integrate preserved natural areas with developed areas for protection of natural ecosystems, visual diversity and definition of community character.
- (3) Significant natural resources shall be designed into the parks and open space system when they exist. Stream related ecosystems, wooded areas and any special conservation values shall be identified and adequate land shall be set aside (outside of 100-year floodplain/water surface elevation) to preserve these areas and to buffer them from adjacent uses. High points and view corridors shall be mapped and preserved for public benefit.

D. SUSTAINABILITY & CONSERVATION:

- (1) Ensure the long-term sustainability of both built and preserved areas.
- (2) Apply xeriscape principles. In accordance with city policy, water management and conservation measures are encouraged. (For guidance, refer to City Code, the Landscape Reference Manual and Aurora Water's Water Management Plan.)
- (3) All projects, regardless of size, shall provide the erosion control BMP's necessary to prevent soil erosion and protect the quality of the stormwater leaving the site.

E. MAINTENANCE & DURABILITY:

- (1) Design concepts and materials should support low maintenance requirements.
- (2) Provide a healthy environment for plant material to grow.
- (3) Equipment and materials shall be able to support extensive public use over a long period of time.

F. ACCESS & CONNECTIVITY:

- (1) Provide a variety of well-connected outdoor opportunities to all the residents of the city.
- (2) Sites and facilities shall be part of an interconnected bicycle and pedestrian system. This system should be off-street with grade-separated crossings at arterial streets whenever possible.

G. IDENTITY / IMAGE:

- (1) Provide attractive spaces with high quality materials and design that encourage residents to gather from the surrounding neighborhood and the city.
- (2) Accommodate elements distinctive to each site and/or neighborhood.

H. INCLUSIVE:

- (1) PROS has adopted the vision to become a leader in providing inclusive spaces for children and families of all ages and all abilities. In accordance with this vision, all new and renovated parks with playgrounds will be required to offer inclusive play opportunities as outlined below:
 - (a) Comply with ADA and go beyond the minimum federal requirements for accessibility by integrating no less than one (1) piece of play equipment that provides meaningful opportunities for children of different abilities to interact, play and learn together.
 - (b) Ensure appropriate access via the provision of accessible routes to inclusive play features.

6.4 ORGANIZATION OF DESIGN CRITERIA

Sections 6.5 through 6.22 are devoted to the presentation of design criteria specific to each category of the PROS classification system. The criteria are organized in the same order as the classification system described in Section 6.2:

- Developed Properties are first.
- Open Space Areas are second.
- Trails are third.
- Criteria for park landscapes and standard site elements are also provided.

Below is a quick reference as to which section to go to for design guidance and information for specific needs.

Developed Properties:

- Section 6.5 – Regional Park Criteria (refer below on this page 44)
- Section 6.6 – Large Urban Park Criteria (refer to page 45)
- Section 6.7 – Special Use Park Criteria (refer to page 46)
- Section 6.8 – Community Park Criteria (refer to page 47)
- Section 6.9 – District Park Criteria (refer to page 49)
- Section 6.10 – Neighborhood Park Criteria (refer to page 49)
- Section 6.11 – Pocket Park Criteria (refer to page 53)
- Section 6.12 – Mini Park Criteria (refer to page 55)
- Section 6.13 – Small Urban Park Criteria (refer to page 57)
- Section 6.14 – Golf Course Criteria (refer to page 62)
- Section 6.15 – Landscaped Median Criteria (refer to page 63)

Open Space Areas:

- Section 6.16 – Natural & Conservation Area Criteria (refer to page 71)
- Section 6.17 – Cultural & Historic Site Criteria (refer to page 72)
- Section 6.18 – Greenway & Greenbelt Criteria (refer to page 73)
- Section 6.19 – Criteria for Open Space Resources (refer to page 74)

Trails:

- Section 6.20 – Trail & Path Criteria (refer to page 77)

General Landscaping:

- Section 6.21 – Landscape-related Criteria (refer to page 84)

Standard Site Elements:

- Section 6.22 – Facilities & Programmatic Elements Criteria (refer to page 87)

6.5 REGIONAL PARK CRITERIA

- A. **GENERAL DESCRIPTION** – The regional park is the largest park type in the classification system and can be resource-based, user-oriented, or contain characteristics of both. Resource-based parks are generally designated for protection of environmental features while allowing recreation use as a complimentary but subordinate function. User oriented parks are constructed to provide specialty park uses and recreation facilities that are of a regional scale or draw due to the provision of unique recreation opportunities which are generally not available at most other parks provided in the system.

- B. **SIZE** – Regional parks vary greatly in size. There is no minimum, maximum, or average size applicable.
- C. **SERVICE AREA** – Regional parks are intended to serve the entire city and even draw users from the greater region or beyond. Because of their large service area, they are generally a drive-to park and should be located on or near arterial streets and provide adequate vehicular parking on-site. A regional park typically attracts visitors living within a one (1) hour drive from the site, although others may drive from farther distances depending on the amenities and activities provided.
- D. **PROGRAMMATIC ELEMENTS** – There is no formula used to decide what types of uses and facilities should be provided in a regional park. The programmatic elements should be influenced by whether the site is intended to be resource-based or user-oriented. The intensity of use and development as well as the degree of preservation is dictated by the intended specialized purpose for which the park is provided and the users it is intended to serve.
- E. **DESIGN REQUIREMENTS:**
 - (1) PROS Consultation – Coordination with PROS is necessary to define appropriate programmatic park elements and to delineate the lands best suited to satisfy the functional needs of the park.
 - (2) Specifications & Details – Construction of the park should conform to PROS’ standard specifications and details but will have custom details related to the proposed use and specialized facility needs.

6.6 LARGE URBAN PARK CRITERIA

- A. **GENERAL DESCRIPTION** – The large urban park is classified as the second largest type of park in the city. A wide variety of community focused and sized facilities are featured at this type of park. These sites should be embedded in residential areas for ease of access and optimization of the service area. Each park should be unique as defined by the natural characteristics of the site and should offer large and small areas that are both formal and informal in nature.
- B. **SIZE** – A large urban park should be approximately one hundred (100) acres in size.
- C. **SERVICE AREA** – Large urban parks serve the entire community, necessitating that they provide on-site motor vehicle parking since many visitors will be residents who drive to the park. An internal network of trails that is well-connected to the citywide trail system is important for access by residents who choose to arrive on foot or by bike.
- D. **PROGRAMMATIC ELEMENTS** – There is no standard list for the type of uses and facilities that should be offered at a large urban park. Programmatic elements should be decided based on community interest and the opportunity that each site affords for satisfying recreation need according to site suitability and compatibility. Because of the scale of these parks, they may be good locations for community-based facilities such as recreation centers and aquatic facilities, but they need not be used to this degree if the park master planning process determines that the intensity of use

should be focused differently. Public art, gardens, and passive/reflective areas are typically incorporated into these parks to diversity recreation experience opportunities.

E. DESIGN REQUIREMENTS:

- (1) PROS Consultation – Coordination with PROS is necessary to define appropriate programmatic park elements and to delineate the lands best suited to satisfy the functional needs of the park.
- (2) Specifications & Details – Construction of the park should conform to PROS' standard specifications and details but will have custom design components related to the proposed use and specialized facility needs.

6.7 SPECIAL USE PARK CRITERIA

- A. **GENERAL DESCRIPTION** – A special use park generally serves a specific and single-use purpose, such as satisfying demand for a particular sport, recreational activity, or special event for the larger community. These parks may also be combined with limited, general recreation facilities and administered to serve local, neighborhood-based recreation needs as well, although that is not their primary function.
- B. **SIZE** – The size of a special use park can vary significantly based on park system needs and opportunities. A site may be small or large, depending on land availability, property use objectives, and the demand for specialized facilities or recreation programs.
- C. **SERVICE AREA** – Most special use parks are community-based, meaning that they serve the entire city, although some may cater to a smaller geographic subarea of the city. Other sites may provide facilities intended to draw visitors from well beyond city boundaries. Because these parks are generally large and intended to serve large numbers of visitors, they require on-site vehicular parking while also benefitting from connectivity to the citywide network of trails.
- D. **PROGRAMMATIC ELEMENTS** – The programmatic elements provided at a special use park are typically user- or market-driven according to community needs and program objectives. As such, the magnitude and type of specialized facilities provided can be very broad. Park uses and facilities are best determined on a case-by-case basis.

E. DESIGN REQUIREMENTS:

- (1) PROS Consultation – Coordination with PROS is necessary to define appropriate programmatic park elements and to delineate the lands best suited to satisfy the functional needs of the park.
- (2) Specifications & Details – Construction of the park should conform to PROS' standard specifications and details but will have custom design components related to the proposed use and specialized facility needs.

6.8 COMMUNITY PARK CRITERIA

- A. **GENERAL DESCRIPTION** – The focus of a community park is on meeting community-based recreation needs through the provision of uses and facilities that have broad and universal appeal to the general population. For a large community like Aurora, needs are satisfied using multiple strategically-located community parks which, out of necessity, serve different geographic parts of the total city. Community parks typically offer standard facilities capable of accommodating larger groups of visitors who come from multiple surrounding neighborhoods. These parks may have active and passive recreation opportunities depending upon community needs and site suitability. Natural features, if any, are commonly preserved and integrated into the overall site design.
- B. **SIZE** – A community park should optimally be forty (40) acres or greater in size, which is generally enough land to accommodate a diverse range of facilities that have broad community appeal.
- C. **SERVICE AREA** – A community park typically is designated to serve an area within a two (2) mile radius. Access to the park should be readily available via major city streets and the citywide trail network. Most visitors drive to participate in the types of recreation activities available at these parks, thereby requiring the provision of vehicular parking lots.
- D. **PROGRAMMATIC ELEMENTS** – A community park is usually developed intensively to support active recreation uses, so extensive level topography for athletic fields and courts, parking lots, and buildings are a necessary characteristic of a site. The extent of the developed space versus what is left in a natural state or restored to a naturalized condition is dictated by facility needs and site suitability. The master planning process will determine the degree of park development appropriate for a site in accordance with the programmatic elements that are required and those that are optional.
- (1) Required Elements:
- (a) **Large playground:** (Refer to Section 6.22.B for design criteria.)
 - (i) Inclusive Play Feature – A minimum of two (2) inclusive play features with appropriate inclusive access shall be integrated into both play areas for each age group of children to provide multiple experiences. (Refer to Section 6.22.B for design criteria.)
 - (b) Large group picnic facilities.
 - (c) Sports fields.
 - (d) Athletic courts
 - (e) Internal paths with connections to off-site trails.
 - (f) Restrooms.
 - (g) Motor vehicle parking.
 - (h) Landscaping and beautification plantings.

- (i) Site furnishings such as:
 - (i) Benches.
 - (ii) Trash receptacles.
 - (iii) Picnic tables.
 - (iv) Bike racks.
 - (v) Bicycle repair station.
 - (vi) Water bottle fillers, possibly supplemented by the addition of drinking fountains.
 - (vii) Pedestrian and security lighting.
- (2) Optional Elements – Additional elements shall be provided based upon site location opportunities and need, such as:
 - (a) Public art elements.
 - (b) Skate parks.
 - (c) Stage/amphitheater.
 - (d) Large community event spaces.
 - (e) Gardens.
 - (f) Night lighting to extend the available hours of use for recreation facilities.
 - (g) Natural resource areas, such as wildlife habitat and native plant communities.
 - (h) Aquatic facilities, including swimming pool or water-based play area.
 - (i) Recreation center.
 - (j) Other facilities and features, as approved by PROS.

E. DESIGN REQUIREMENTS:

- (1) City Ownership – As stated in earlier sections of this manual, city policy requires developers to dedicate land for community park purposes to help satisfy the fundamental recreation needs of new residents they introduce into the city. **If a developer decides to dedicate on-site community park land to fulfill this obligation, said land shall be owned and maintained by the city.** Ownership, operation and maintenance of community park land by a non-city entity is not an option because PROS must have the ability to program its use to maximize community benefit.
- (2) Street Boundaries – Arterials and/or collector streets should be on at least two (2) sides of the park. Park boundaries with neighborhood streets or residential uses should not be the majority.
- (3) Active Recreation Buffers – Facilities within the park shall be set back far enough to minimize the visual and auditory impacts from/to adjacent uses:

- (a) **Streets** – Active recreation uses and facilities shall be located a minimum of fifty feet (50') from street rights-of-way to increase public safety.
 - (b) **Single Family Residential** – Active recreation uses and facilities shall be located a minimum of fifty feet (50') from single family lots to lessen impacts to such residential areas.
- (4) **School-Parks** – Depending on circumstances, locating a community park adjacent to a school site can help fulfill the 40-acre minimum park size requirement. Planning coordination with the school district to pair together a park and a middle school may be possible if facilities common to both types of sites can be shared without causing programming conflicts. Co-locating facilities can result in efficiencies for developers because overlapping acreage can be credited as community park land even though the land is not dedicated exclusively for park purposes. All proposed school-parks shall be reviewed and approved by PROS and school district staff to ensure shared use compatibility and to except out school buildings and other ineligible facilities from the credited acreage.
- (a) **Park Tract** – In cases of co-location, the overlapping acreage should be part-and-parcel of the community park tract rather than the school property in order to safeguard perpetual use of the area for public recreation benefit.
- (5) **PROS Consultation** – Coordination with PROS staff is necessary to define appropriate programmatic park elements and to delineate the lands best suited to satisfy the functional needs of the park.
- (6) **Specifications & Details** – Construction of the park shall conform to PROS' standard specifications and details but will have custom design components related to the proposed use and specialized facility needs.

6.9 DISTRICT PARK CRITERIA

A district park is a hybrid between a community park and a neighborhood park. This type of park was introduced into the city's classification system to recognize sites that do not fit neatly into either category but are rather a mix of some characteristics of both categories. Irregularities among the parks are varied due to how the park system developed organically over time without the aid of a classification system to guide its growth.

Because new district parks should not be developed as the park system expands in the future, no criteria are provided for this park type.

6.10 NEIGHBORHOOD PARK CRITERIA

- A. **GENERAL DESCRIPTION** – The three building blocks that PROS relies upon to build a good parks, recreation and open space system are neighborhood parks, community parks and open space; but it is the neighborhood park which is the cornerstone of the system because its purpose is to meet residents' basic recreation

needs close to their homes. The neighborhood park is the most prevalent type of park provided throughout the city as a result of implementation of an underlying goal to provide fundamental recreation facilities within walking and biking distance of most people. For this reason, city policy has for years required that developers dedicate land and construct facilities for neighborhood park purposes as growth and development occurs. These parks, which serve as the recreational and social focus of neighborhoods, contribute to the quality of life in the older, well-established areas of Aurora and the newer parts of the city.

Neighborhood parks, by design (i.e., deliberate planning of size and program), provide recreation space and facilities for the immediate neighborhood in which they are located. Users are expected to walk and bike to access these parks using trails, sidewalks, on-street bicycle facilities, or shared lanes of local, low-volume streets. Each park should have a unique character to help create a sense of place, with amenities which cater to the surrounding identity of the neighborhood. Amenities chosen for each park should recognize the recreation opportunities provided at nearby locations and should aim to fill any gaps in available facilities, where possible.

- B. **SIZE** – Generally, neighborhood parks range in size from five (5) to fifteen (15) acres. The population density of the park’s service area as well as local facility demand and needs may be determinants of size.
- C. **SERVICE AREA** – A neighborhood park is considered a walk-to and bike-to facility serving residents within a one-half (½) mile radius.
- D. **PROGRAMMATIC ELEMENTS** – The focus of a neighborhood park is to provide informal, active, and reflective recreation opportunities for people of all ages. The master planning process will determine the degree of park development appropriate for a site in accordance with the programmatic elements that are required and those that are optional.

(1) Required Elements:

- (a) **Playground:** (Refer to Section 6.22.B for design criteria.)
 - (i) Inclusive Play Feature – Playgrounds shall provide a minimum of one (1) inclusive play feature with appropriate inclusive access.
- (b) Picnic facility with shelter.
- (c) Open, multi-purpose turf area (i.e. 300’ x 225’ or other dimensions based on site design parameters).
- (d) Internal paths with connections to off-site trails.
- (e) Landscaping and beautification plantings.
- (f) Site furnishings such as:
 - (i) Benches.
 - (ii) Trash receptacles.
 - (iii) Picnic tables.
 - (iv) Bike racks.

- (v) Water bottle filler or drinking fountain.
 - (vi) Security lighting.
- (2) Optional Elements – Additional elements shall be provided based upon site location opportunities and need, such as:
- (a) Restrooms (desirable but not always provided).
 - (b) Courts (may be required by PROS if there is a gap needing to be filled).
 - (c) Public art elements.
 - (d) Natural resource areas, such as wildlife habitat and native plant communities.
 - (e) Bicycle repair station.
 - (f) **Motor Vehicle Parking** – Parking is not typically provided in neighborhood parks but should be considered if on-street parking is not available adjacent to the park and when ADA access cannot otherwise be accommodated. Facilities that are “drive-to” in nature should be avoided in neighborhood parks to minimize the need for on-site parking. Land dedication credit eligibility for parking areas is as follows:
 - (i) Generally, parking areas within neighborhood parks shall not receive land dedication credit.
 - (ii) If parking is provided to satisfy ADA requirements by providing an accessible route to programmatic elements within the neighborhood park when no other option is available, land dedication credit shall be given.
 - (g) Other facilities and features, as approved by PROS.

E. DESIGN REQUIREMENTS:

- (1) PROS Consultation – Coordination with PROS is necessary to define appropriate programmatic park elements and to delineate the lands best suited to satisfy the functional needs of the park.
- (2) Residential Surroundings – It is preferred that neighborhood parks be located within geographic areas that are generally comprised of residentially-zoned land to maximize close-to-home public access and benefit. Parks should have multiple access points via trails and sidewalks.
- (3) Street Boundaries – Neighborhood parks shall not be surrounded completely by streets but should instead abut a variety of residential uses, schools, activity centers and open spaces. At least one side of the park should be defined by a residential street to provide maintenance access and opportunities for public and police surveillance. Arterial street and highway boundaries are not acceptable for neighborhood parks.

- (4) **Active Recreation Buffers** – Facilities within the park shall be set back far enough to minimize the visual and auditory impacts from/to adjacent uses:
- (a) **Streets** – Active recreation uses and facilities shall be located a minimum of fifty feet (50') from local or collector street rights-of-way, or a greater distance at the discretion of PROS to increase public safety.
 - (b) **Single Family Residential** – Active recreation uses and facilities shall be located a minimum of fifty feet (50') from single family lots to lessen impacts to such residential areas.
 - (c) **Wider Buffers** – At the discretion of PROS, wider buffers internal to the park may be required based on the nature of park facilities and adjacent land uses. Criteria used to make decisions as to whether sufficient buffer space is provided include:
 - (i) The configuration of the park.
 - (ii) The recreation uses and activity areas in proximity to the edge of the park.
 - (iii) The street classifications which surround the park, including projected traffic volumes and speeds.
 - (iv) The design of berming, if any, along the periphery of the park.
 - (v) The provision of landscaping along the periphery of the park, including plant material types and their sizes at time of planting and at maturity.
 - (vi) The type and location of fencing along the periphery of the park, including its height in relationship to any berming and landscaping.
- (5) **Adjacent Height Limitations** – Neighborhood parks shall not be located adjacent to buildings and structures taller than fifty feet (50'), or telecom facilities, in order to minimize visual impacts.
- (6) **Infrastructure** – Ideally, all adjacent infrastructure should be in place as a result of surrounding development prior to construction of a neighborhood park. At a minimum, water infrastructure required to service the park must be in place and adjacent streets must be constructed or the street design shall be completed so that horizontal and vertical elevations are known in order to inform the park design.
- (7) **City Ownership** – There are special requirements applicable to parks if they are city owned and maintained:
- (a) **Minimum Size** – As a type of park that new residential developments are required to provide on-site (or satisfy through the payment of cash-in-lieu of land dedication and park development fees), the goal is that new neighborhood parks be at least five (5) acres in size. This shall be the minimum size requirement if the park is dedicated to the city for ownership and maintenance.
 - (b) **Inclusive Play Features** – City owned parks shall include a minimum of two (2) inclusive play features and be integrated into both play areas for each age group of children to provide multiple experiences. (Refer to Section 6.22.B for design criteria.)

- (c) **Restrooms** – A portable toilet enclosure or vault toilet shall be required.
 - (d) **Potable Drinking Water** – Water bottle fillers shall be provided, possibly supplemented by the addition of drinking fountains.
 - (e) **Specifications & Details** – Construction of the park should conform to PROS' standard specifications and details but will have custom design components related to the proposed use and specialized facility needs.
- (8) **Non-city Ownership** – Under special circumstances, and provided the site programmatically complies by offering all the basic facilities of a neighborhood park, a site as small as three (3) acres in size may be approved. These smaller parks shall be non-city owned and maintained.
- (9) **School-Parks** – Depending on circumstances, locating a neighborhood park adjacent to a school site can help fulfill the 5-acre minimum park size requirement. Planning coordination with the school district to pair together a park and an elementary school may be possible if facilities common to both types of sites can be shared without causing programming conflicts. Co-locating facilities can result in efficiencies for developers because overlapping acreage can be credited as neighborhood park land even though the land is not dedicated exclusively for park purposes. All proposed school-parks shall be reviewed and approved by PROS and school district staff to ensure shared use compatibility and to except out school buildings and other ineligible facilities from the credited acreage.
- (a) **Park Tract** – In cases of co-location, the overlapping acreage should be part-and-parcel of the neighborhood park tract rather than the school property in order to safeguard perpetual use of the area for public recreation benefit.

6.11 POCKET PARK CRITERIA

- A. **GENERAL DESCRIPTION** – Pocket parks supplement available recreation opportunities in proximity to residents' homes by focusing on passive park spaces for unstructured recreational activity and contemplative use. These parks are typically located on a local street and bordered by low intensity uses, including primarily residential lots. A pocket park is generally too small to offer the full spectrum of facilities found in neighborhood parks, but it commonly provides at least two (2) of the basic facilities, such as a small playground, picnicking, and/or open, multi-purpose turf areas.

Because a pocket park is capable of partially meeting neighborhood-based recreation needs, these sites receive special consideration toward satisfying PROS' neighborhood park and open space requirements:

- (1) **Satisfying Neighborhood Park Requirements** – Pocket parks may be used to fill in gaps between service areas of parks when sufficient acreage is dedicated to meet the total required neighborhood park land but the parks are located too distant from each other to achieve coverage for all residents. A pocket park

serving this function shall be developed to accommodate the full spectrum of required programmatic elements for a neighborhood park as set forth in Section 6.10.D. In this case, the pocket park serves a park need, but the acreage may only be counted as open space for purposes of land dedication credit.

- (2) Satisfying Open Space Requirements – The acreage of a standard pocket park may count as dedicated open space land if the park is programmatically in compliance with the requirements of Section 6.11.D.

B. **SIZE** – Pocket parks are greater than one-half ($\frac{1}{2}$) acre and less than five (5) acres in size.

C. **SERVICE AREA** – A $\frac{1}{4}$ -mile service area shall apply to a pocket park provided to fill a gap in an area that is unserved or underserved by neighborhood park land.

D. **PROGRAMMATIC ELEMENTS** – The master planning process will determine the degree of park development appropriate for a site in accordance with the programmatic elements that are required and those that are optional.

- (1) Required Elements:

- (a) Open turf area suitable for informal play and games. (Minimum size and layout will vary based on pocket park size, location and design.)

- (b) Landscaping.

- (c) Site furnishings such as:

- (i) Benches.
- (ii) Trash receptacles.
- (iii) Picnic tables.
- (iv) Bike racks.
- (v) Security lighting.

- (d) A minimum of one (1) additional facility shall be provided to augment pocket park opportunities:

- (i) Playground.
- (ii) Shelter.
- (iii) Court(s).
- (iv) Garden(s).

- (2) Optional Elements – Additional elements shall be provided based upon site location opportunities and need, such as:

- (a) Improvements that are supportive of a theme for the neighborhood or the development, such as public art, at an appropriate scale.

- (b) Other facilities and features, as approved by PROS.

E. **DESIGN REQUIREMENTS:**

- (1) PROS Consultation – Coordination with PROS is necessary to define appropriate programmatic park elements and to delineate the lands best suited to satisfy the functional needs of the park.

- (2) **Non-city Ownership** – Due to their small size, pocket parks shall be owned and maintained by a non-city entity, such as a metropolitan district or homeowner’s association. The exception to this rule is as follows:
 - (a) **City Ownership** – In no case will a pocket park be considered for city ownership unless it is at least five (5) acres in size, adjacent to other city owned and maintained open space, and includes programmatic park elements that are acceptable to PROS. In the event the city accepts ownership and maintenance of a pocket park, construction of the park should conform to PROS’ standard specifications and details but will have custom design components related to the proposed use and specialized facility needs.

6.12 MINI PARK CRITERIA

- A. **GENERAL DESCRIPTION** – A mini park is a small recreation space surrounded entirely by streets. This type of park offers very limited recreation facilities and serves the dual purpose of meeting the unstructured recreation needs of persons living in immediately surrounding residential areas and being an aesthetic landmark or focal point around which a sub-neighborhood is oriented.

Because mini parks are neither required for land dedication nor endorsed as a way to meet traditional park needs, PROS does not allow such sites to be counted toward satisfying park land dedication requirements. However, mini park acreage may be used to help satisfy the open space land dedication requirement:

- (1) **Open Space Credit** – Any area surrounded by a street that is not otherwise characterized as a park under the PROS park classification system, may be eligible to receive open space land dedication credit if the criteria in paragraphs B and D in this Section 6.12 are met.

- B. **SIZE** – At least one-half (½) acre (21,780 square feet) of contiguous land shall be required per individual site. Areas occupied by lands or uses which are prohibited from receiving land dedication credit also shall not count toward the minimum site size.
- C. **SERVICE AREA** – Because of their limited size and facilities, mini parks serve concentrated population areas. No service area standard is established for these parks because they are ineligible to receive park land dedication credit and may not be used to fill in the gaps between neighborhood park service area radii.
- D. **PROGRAMMATIC ELEMENTS** – Because the geometry of a street network can result in irregularly shaped tracts with marginally usable spaces, not all land that falls inside a tract/parcel surrounded by streets may qualify for land dedication credit. The below criteria shall set the standards for spaces deemed eligible as well as areas that will not be eligible to satisfy land dedication requirements.
- (1) **Boundary Criteria** – Area calculations and dimensions shall be measured from the rights-of-way of public streets and from the back of curb of private streets.

(2) Street Classification Criteria:

- (a) A maximum of one (1) abutting street may be a collector street.
- (b) Other abutting streets shall be local streets or private streets that are the equivalent of a local street.
- (c) Arterial streets shall not abut.

(3) Dimensional Criteria:

- (a) More than 50% of the longest dimension of an area must be a minimum of one hundred feet (100') wide.
- (b) Any area that is less than twenty-five feet (25') in width shall not count toward the minimum site size or be eligible for land dedication credit.

(4) Buffer Criteria:

- (a) A twenty-five feet (25') wide buffer, measured from the back of curb, shall be provided adjacent to all streets and from the boundary of any adjacent incompatible use or hazard.
- (b) The buffer shall include a combination of the following vertical elements to provide an adequate physical barrier between the street and the interior programmatic elements that provide recreation value for the site:
 - (i) Landscaping.
 - (ii) Berm landforms.
 - (iii) Raised planters.
 - (iv) Walls.
 - (v) Seatwalls.
 - (vi) Open style fencing.
- (c) Vertical elements used within the perimeter buffer shall be context-sensitive based on external and internal influences, including the use of features that will complement the recreation value of the site.
- (d) Variation in the vertical elements along the perimeter will be allowed, with gaps in the buffer provided for physical and visual access to the site, as appropriate.
- (e) The distance that recreation uses are set back from the street and the nature of the facilities themselves shall be determinants for the appropriate scale and type of vertical elements. For example, a fence or wall will be less important as a safety measure if sufficient distance between the facilities and streets is provided.
- (f) Where plant material is used on its own or in conjunction with another element, the buffer need not be planted the entire twenty-five feet (25') width. Instead, the intent is to achieve an aesthetic, functional delineation at the edge of the site to define the space and separate it from the streets, which may be accomplished with minimal landscaping.

- (g) Sidewalks may meander through the buffer space or parallel the curbs of the streets.
- (5) **Recreation Value Criteria:** The area shall provide recreation value by offering the following programmatic elements:
 - (a) **Required Elements:**
 - (i) Internal circulation paths.
 - (ii) Benches.
 - (iii) Tables.
 - (iv) Trash receptacles.
 - (v) Pet waste stations.
 - (vi) Landscaping.
 - (b) **Optional Elements** – One or more of the following additional elements shall be provided based upon site location opportunities and need, such as:
 - (i) Small playground area with equipment that offers diverse play opportunities for children and with safety surface.
 - (ii) Open turf field with minimum size of 75' x 50' for informal play; buffer area cannot be counted toward minimum size.
 - (iii) Play court for basketball, pickleball or volleyball, etc.
 - (iv) Artwork with enhanced setting (larger artwork may not need enhanced setting).
 - (c) May include the following:
 - (i) Demonstration xeric garden or perennial/shrub garden.
 - (ii) Small shelter.
 - (iii) Lighting.
 - (iv) Other facilities and features as approved by PROS.

E. DESIGN REQUIREMENTS:

- (1) **PROS Consultation** – Coordination with PROS is necessary to define appropriate programmatic park elements if open space land dedication credit is sought.

6.13 SMALL URBAN PARK CRITERIA

- A. **GENERAL DESCRIPTION** – Small urban parks (SUPs) provide park space within parts of the city that are planned or developed at an urban scale where limited land is available for the provision of other larger types of parks. Areas appropriate for SUPs include urban centers, transit-oriented developments, and infill development parcels where development has a compact form with densities that are higher than surrounding areas. SUPs complement and integrate with surrounding uses and are intended to serve two functions: 1) to provide facilities to meet the park needs of residents by serving as a place for social interaction and leisure opportunities, and 2) to create focal points and activity nodes within the urban fabric of the city. Examples of SUPs include:

- Greens / Commons – Public areas consisting of predominantly open lawn areas for unstructured recreational use partially surrounded by streets and the fronts of buildings.
- Squares – Public areas that adjoin streets on three (3) sides and are surrounded by the fronts of buildings with a prominent feature designed as a centerpiece of the space having formally arranged walks and landscaping.
- Plazas – Public areas that are predominantly paved, open-air spaces enclosed on two or more sides by buildings and bounded by one or two streets.
- Promenades – Public areas set aside as a principal means of access to and through an urban setting for pedestrians and possibly bicyclists, facilitating connectivity between public streets, private property and civic destinations.

Although City Code does not require that land be dedicated for SUP purposes, SUPs are eligible to satisfy park and open space land dedication requirements under certain circumstances. A SUP may offset the amount of land otherwise required to be dedicated in the following ways:

- (1) Satisfying Neighborhood Park Requirements – SUPs may be used to satisfy, in whole or in part, neighborhood park land dedication requirements within developments that qualify as infill and/or transit station areas. Refer to Section 3.1.E for criteria regarding qualifying developments.
- (2) Satisfying Open Space Requirements – SUPs may be used to satisfy, in whole or in part, open space land dedication requirements within developments that qualify as an urban center. Refer to Section 3.1.G for criteria regarding qualifying developments.

- B. **SIZE** – A SUP shall be no less ten thousand (10,000) square feet in size.
- C. **SERVICE AREA** – SUPs less than one-half ($\frac{1}{2}$) acre in size have a service area of one-quarter ($\frac{1}{4}$) mile radius. Sites that are equal to or greater than one-half ($\frac{1}{2}$) acre in size have a service area radius of half ($\frac{1}{2}$) mile.
- D. **PROGRAMMATIC ELEMENTS** – The programmatic elements to be provided within a SUP should be discussed with PROS prior to site plan, preliminary plat or final plat submittal. The master planning process will determine the appropriate uses and facilities for a site. The goal is for SUPs to provide a variety of features and experiences to the new residents and visitors of a development. The following lists include potential programmatic elements and describe appropriate expectations. During the review process, PROS will work with the developer to agree upon a design that addresses both the park needs and design concepts of the development.
- (1) Basic Elements – Typically, SUPs will be expected to contain most of these elements, but their quantity and form will be determined on a case-by-case basis:
 - (a) Internal circulation network.
 - (b) Seating – benches, planters, walls, etc.

- (c) Landscaping (in beds, planters or tree wells).
 - (d) Site furniture – trash receptacles, tables, drinking fountains, BBQ grills, etc.
 - (e) Bicycle support facilities – bike racks, bike lockers, etc.
 - (f) Special pavement.
 - (g) Lighting – ornamental pedestrian-scale light standards.
 - (h) Signage – park identification signs, sign kiosks, etc.
 - (i) Restrooms.
- (2) Recreation Features – Due to the fact that SUPs may count toward satisfaction of park land dedication requirements, the intent is for them to provide meaningful recreation, education or conservation benefits similar to what is found in neighborhood parks. Therefore, each SUP should include a minimum of two (2) of these features, as appropriate for the development’s size and land uses:
- (a) Open turf area.
 - (b) Shelter or shade structure – gazebo, arbor, etc.
 - (c) Play sculptures or play equipment with safety surface.
 - (d) Sprayground / interactive fountain.
 - (e) Hard surface sports court.
 - (f) Trail corridor or connection.
 - (g) Community gardens.
 - (h) Amphitheater.
 - (i) Interpretive display.
 - (j) Commemorative monument or artifact.
 - (k) Significant natural, cultural or scenic resource.
- (3) Special Features – The benefits of these features are more visual and emotional than recreational, but greatly enhance urban environments where people work, shop and live. Therefore, each SUP should contain a minimum of one (1) of these, as appropriate for the development’s size and land uses:
- (a) Public art.
 - (b) Water features – decorative fountains/pools, waterscapes, etc.

- (c) Gardens with special designs or theme.
- (d) Banners/decorative flags (in conjunction with another item from this Special Features list).
- (e) Ornamental fencing and gates.
- (f) Special lighting effects.

E. LOCATION GUIDELINES:

- (1) SUPs should be equitably distributed throughout a project, yet strategically located in proximity to the urban population that they serve, including employees, visitors, shoppers and residents of offices, retail and residential uses.
- (2) SUPs should be placed adjacent to civic buildings, such as libraries, community centers and schools, to encourage mixed use activity centers.
- (3) SUPs should be located such that the mass and height of surrounding buildings in relationship to solar orientation does not unreasonably cast shadows during the year that would render the site undesirable for public uses and activities.
- (4) SUPs may not be surrounded by streets on all sides unless determined appropriate based on size and context by PROS. Street frontages may include a maximum of one (1) arterial street. Other abutting streets should be collector or local streets.
- (5) SUPs should be aligned with sidewalks and trails and destinations on adjoining property to facilitate direct pedestrian and bicycle connectivity.
- (6) SUPs co-located with transit facilities should be designed to minimize breaks in pedestrian/bicycle circulation patterns and to avoid the division of activity centers.
- (7) For safety and security, unobstructed views from street frontages and adjacent land uses into SUPs should be maintained. For urban design purposes, clear views through SUPs to distant focal points may be appropriate.

F. GENERAL DESIGN GUIDELINES:

- (1) SUPs should be open to public use during regular park operation hours in accordance with PROS' rules and regulations for parks.
- (2) Coordination with PROS is necessary to define appropriate programmatic elements and to design a site best suited to satisfy the functional needs of the adjoining development as well as serve the extended community.
- (3) SUPs should be appropriately scaled pedestrian-oriented spaces designed to accommodate short-term, informal activities.

- (4) The user experience at SUPs should be geared toward social interaction and leisure opportunities and may not preclude the general public from utilizing the facility.
- (5) SUPs should serve as landmarks, focal points and centers of activity relative to other complementary uses (not necessarily at the geographic center of the development).
- (6) SUPs should help to create a visual identity to strengthen a sense of place and orientation through specific design criteria.
- (7) Entry points into SUPs should be highly visible and inviting through well-lit, architecturally prominent features.
- (8) SUPs may be established for commemorative purposes having a central focal point with a mix of design elements that focus attention on a monument or public art.
- (9) SUPs should be accessed principally by walking and bicycling, and transit stops may be nearby.
- (10) Transit facilities, such as light rail stations and bus transfer stations, should be integrated along the periphery of SUPs to work in concert with and complement transit use where context-appropriate.
- (11) Trails and connections from on-street bicyclic facilities should be incorporated into SUPs to accommodate walking and bicycling accessibility where context-appropriate.
- (12) SUPs that are in the vicinity of ground floor residential, retail, office and civic building uses shall generally be defined by landscaping in beds or planters; short, open-style fences; walls functioning as seating space; stairs/steps; or distinct paved surfaces serving as pedestrian zones around their perimeter. See Section 6.13.G below for SUP setback requirements.
- (13) Expansive paved areas and key pedestrian zones in SUPs should have a distinctive surface or pattern that provides an organizing framework to the nature of the site and relates it to other public areas in the development.
- (14) SUPs should be designed and constructed with high quality materials that are durable and convey a consistent visual image and sense of identity for the larger community as well as the immediate development area.
- (15) SUPs should offer an inviting and safe atmosphere with strategically placed security lights and orientation toward adjacent uses.

G. **SUP SETBACK** – The interface between the public space of a SUP and abutting private property should be free of encumbrances that could interrupt pedestrian flow and diminish public use. To allow space for an adequate transition zone between public areas and private property / business activities, a SUP setback measured a distance of ten feet (10') from the footprint of abutting buildings and private accessory

spaces (i.e., queuing areas, service and maintenance access, and residential patio areas) shall generally apply to establish the boundary of an area eligible to receive credit as a SUP:

- (1) Setbacks shall be measured from the ground floor level of adjoining buildings and will not be measured from the edges of cantilevered balconies, overhangs, and other structural features which are intended to provide shade within or be an integral design component of the SUP.
- (2) When appropriate, the design of the transition zone shall create a buffer which reduces the potential for activities on one side of the zone to negatively impact activities on the other side. Otherwise, the zone shall provide for circulation around and maximum use of the SUP.
- (3) The footprint of transportation infrastructure (i.e., street and transit rights-of-way) within and adjacent to a SUP, including any applicable SUP setback, shall not be eligible to receive land dedication credit.

H. **DESIGN REQUIREMENTS:**

- (1) PROS Consultation – Coordination with PROS is necessary to define appropriate programmatic park elements and to delineate the lands best suited to satisfy the functional needs of the park.
- (2) Non-city Ownership – Due to their small size, SUPs shall be owned and maintained by a non-city entity, such as a metropolitan district or homeowner’s association. The exception to this rule is as follows:
 - (a) **City Ownership** – In no case will a SUP be considered for city ownership unless it is at least five (5) acres in size, in proximity to other city owned and maintained assets, and includes programmatic park elements that are acceptable to PROS. In the event the city accepts ownership and maintenance of a SUP, construction of the park shall conform to PROS’ standard specifications and details but will have custom design components related to the proposed use and specialized facility needs. Any SUP intended to be dedicated for city ownership must be approved by PROS prior to approval of a site plan, preliminary plat or final plat. The viability of city ownership shall be evaluated and a decision shall be rendered early in the planning and design process.

6.14 GOLF COURSE CRITERIA

- A. **GENERAL DESCRIPTION** – Golf courses play an important role in satisfying the specialized recreation needs of the population. These sites cater to golfing activity and generally serve a limited sector of the population interested in playing the game of golf and willing to pay a fee to do so. Although golf courses fall under the purview of PROS through its Golf Division, they are managed as an enterprise fund. Decisions regarding development, improvement, and modification of the courses are governed by funding availability and the need for the Division’s operations to be self-sustaining.

- B. **SIZE** – There are no applicable minimum or optimum size standards. The acreage of a golf course is dictated by design.
- C. **SERVICE AREA** – There is no applicable service area standard. City golf courses are open to the general public and available for any paying golfer to use regardless of residency or proximity.
- D. **PROGRAMMATIC ELEMENTS** – There is no standard list for the type of programmatic elements that should be offered at a golf course. Because the existing supply of golf courses is determined to be adequate into the foreseeable future, facility needs will be decided in accordance with management and operational decisions related to funding availability. Maintaining existing facilities will be the focus unless opportunities arise to add new, compatible facilities at courses to generate revenue and help sustain the golf program. Programmatic decisions will be made on a case-by-case basis.
- E. **DESIGN REQUIREMENTS:**
 - (1) PROS Consultation – Coordination with PROS through its Golf Division is necessary to define appropriate programmatic elements and to delineate the lands best suited to satisfy the functional needs of the golf course.
 - (2) Specifications & Details – Construction at golf courses will have custom design components related to the proposed use and specialized facility needs.

6.15 LANDSCAPED MEDIAN CRITERIA

- A. **GENERAL DESCRIPTION** – A landscaped median is the portion of a street separating opposing directions of vehicular traffic and which is linear in form, typically raised above the roadway surface by a vertical feature, such as a curb, and which includes any one or a combination of living plant material consisting of trees, shrubs, grasses, and groundcovers and non-living materials including boulders, cobble, rock, wood chips or shredded bark, and decorative concrete; created as an environmental and aesthetic enhancement to the character, function, and safety of the street.

The Public Works Department sets forth standards for the inclusion of raised medians to safely direct and separate traffic along arterial streets. Aside from establishing and applying these basic standards to street design and construction projects, Public Works does not play a direct role in enhancing the streetscape with landscaped plantings in the medians. Instead, this is a function – to manage landscaping features which improve the character, appearance and travel experience on select arterial streets – of PROS.

- B. **SIZE** – Dimensional criteria for landscaped medians can be expressed in two ways – length and width. The length of a median is dictated by street design and will vary from street to street. The width of a median is governed by the Public Works Department’s standards. Typical street cross sections require twenty-six feet (26’) wide raised medians for major arterial streets.
- C. **SERVICE AREA** – A service area standard does not apply to landscaped medians. Such improvements generally enhance the driving experience for motorists but they

also contribute to the beautification of the street, thereby benefitting the adjoining land uses and neighborhoods along the corridor. Decisions as to which major arterial streets receive landscaping in the medians are made year-to-year based on funding availability and other criteria with input from elected officials.

D. APPLICABILITY & SCOPE:

- (1) Intent – The criteria serve as minimum standards for the design, construction, repair, replacement and reconstruction of landscaped medians along major arterial streets. Their purpose is to meet the needs of vehicular access and safety with functional, aesthetic, and economical design solutions. The criteria are intended to serve as standards for medians that will be maintained by the city, but may also guide the design for medians maintained by non-city entities, such as metropolitan districts or homeowner’s associations.
- (2) Historical Context – The improvement of major arterial street medians with landscaping has occurred over the course of many decades, under various leaderships, and following different standards that have evolved over time. The result of this varied past is that landscaped medians are not uniformly designed throughout the city. The dilemma that PROS faces in setting design criteria for medians is that one set of criteria will not suffice to address all potential design circumstances the department and developers may have to deal with as medians are impacted by development activities. For example, a contemporary, preferred design treatment cannot be applied everywhere, particularly along streets where a different set of older criteria were in place at the time the median was originally installed.
- (3) Applicability – An underlying goal of these design criteria is to promote uniformity in the treatment of major arterial landscaped medians for common visual effect, sustainability and ease of maintenance, particularly when they are maintained by the city:
 - (a) The criteria shall be applied to new medians to be maintained by PROS.
 - (b) Medians that will be maintained by a non-city entity may conform to these criteria or, at the developer’s choosing, a different design may be permitted with approval from PROS.
- (4) Adjustments – Deviations or variances from these criteria may be approved by PROS provided the adjustments do not adversely affect the function of the street or the health, safety and welfare of motorists. It shall be the responsibility of the developer to demonstrate justification for adjustments to the satisfaction of PROS.
- (5) Maintenance Acknowledgement – Developers must declare their intentions for median maintenance by explicitly stating their decisions within master plans, site plans, preliminary plats, civil CDs or other applicable documents/plans that are processed for development approval and permitting:
 - (a) If the intent is for the median to be city maintained, this fact shall be clearly stated on relevant sheets/plans, including an acknowledgement

that the median shall be designed and constructed to conform to PROS' standards and be maintained by the developer during a three (3) year warranty & maintenance period required for xeric-based median designs (Refer to Section 8.3.I of this manual for warranty and maintenance responsibilities.)

- (b) If the intent is for the median to be non-city maintained, this fact shall be clearly stated on relevant sheets/plans, including an acknowledgement that the median shall be designed, constructed and maintained by the applicable non-city entity in perpetuity.
 - (i) An Intergovernmental Agreement (IGA) between the city and the non-city entity shall be executed to outline the terms and conditions of maintenance responsibilities.

(6) PROS Consultation:

- (a) Developers who will be constructing new arterial streets should refer to the maintenance scenario options presented in Section 2.5.D of this manual and consult with PROS staff prior to making design, construction and maintenance decisions.
- (b) Developers who impact existing landscaped medians that are maintained by PROS shall coordinate with PROS staff in accordance with Section 5.4.D of this manual to ensure that appropriate design standards, whether they be old or current, are used to retrofit the median.

- E. **DESIGN PRINCIPLES** – PROS has designed and implemented many miles of landscaped medians in the city, with the earliest projects undertaken in the 1970s. Through PROS' extensive experience, staff have been able to identify characteristics of effective planting designs and to define the elements that satisfy needs for safety, aesthetics and maintenance. The extent to which medians have been landscaped with plant material and irrigated has evolved over time. Current practice is to implement landscaping practices that are xeric-based, more self-sustainable, and less maintenance intensive.

Landscaped median design criteria are formulated with the following principles in mind:

(1) Identity / Image:

- (a) Provide attractive, high quality designs with hardscape and landscape features that provide a positive presence in the street and reduce the negative impacts of pavements and vehicles.
- (b) Enhance the city's image and identity on high visibility corridors.
- (c) Promote the city's adopted xeric design standards for water efficiency.
- (d) Create a unique median treatment that people identify with Aurora.

- (e) Accommodate distinctive elements that enhance the identity of special areas or corridors.
- (2) Continuity:
- (a) Achieve continuity through the repetition of design elements.
 - (b) Consistency is important from street to street and within very long streets to reinforce Aurora’s identity.
- (3) Balance – When possible, design elements within the median should complement each other as well as the surrounding landscapes adjacent to the right-of-way.
- (4) Flexibility – Design elements should lend themselves to being rearranged to accommodate the unique opportunities and constraints of individual sites.
- (5) Maintenance:
- (a) Design concepts and materials should support low maintenance requirements.
 - (b) Provide a healthy environment for plant material to grow.
 - (c) Plant material should be water-wise, de-icer tolerant and drought and disease resistant; compatible with severe micro climates.
 - (d) Where irrigation is needed, employ irrigation techniques that reduce water runoff and overspray to adjacent street pavement.
 - (e) Minimize conflicts with public utilities.
- (6) Safety:
- (a) Maintain a functional and safe environment for motorists, bicyclists and pedestrians.
 - (b) Maintain traffic safety by adhering to “sight distance” requirements and recognizing potential conflicts with errant vehicles.
 - (c) Provide “safe zones” for maintenance activities, access and temporary parking of maintenance vehicles/equipment.

F. STANDARD DESIGN ELEMENTS – Arterial landscaped medians should include the following standard design elements:

- (1) Irrigation System – PROS has adopted a xeric standard which eliminates the need for a long-term irrigation system. Where existing irrigated medians are being impacted or modified by development, a system using subsurface drip tubing and spray/bubble heads may be required to maintain the health of existing trees and other groundcover.

- (2) Median Cover – Median cover is the surface treatment between the backs of median curbs that is used where a median is too narrow for plant material. Below are criteria associated with this element:
- (a) PROS staff will make determinations on a case-by-case basis as to whether concrete cover is warranted for a median cover or whether plant material can be accommodated between the backs of median curbs.
 - (i) The concrete median cover shall be integrally colored with Davis Color: Omaha Tan or approved equal. The concrete median cover shall have a five-foot by five-foot (5' x 5') control joint grid pattern running parallel to direction of vehicle travel and have a light broom finish. Alternative concrete colors and/or control joint patterns will not be permitted without the approval of PROS.
 - (ii) All other aspects of concrete median cover shall conform to the city's *Roadway Design and Construction Specifications*, latest edition.
 - (b) Alternative pavement materials, such as washed river rock, shall not be used unless approved by PROS.
- (3) Maintenance Access Area – A maintenance access area is an area outside of the flow of traffic that serves as a safe place for maintenance vehicles and equipment to be parked and which provides maintenance personnel access to the landscaped areas via an access ramp. Below are criteria associated with this element:
- (a) Concrete maintenance access areas shall be a minimum of fifteen feet (15') wide and fifty feet (50') long and uninterrupted by plants, light poles or other above-ground obstructions.
 - (b) Maintenance access areas shall be directly adjacent to plant bed areas that they serve.
 - (c) Location and frequency of maintenance access areas shall be coordinated with and approved by PROS. In most locations, it should be necessary for only one maintenance access area at one end of a landscaped area.
- (4) Splashblock – A splashblock is a raised concrete “skirt” around the perimeter of a landscape area that elevates and protects the landscape from grime, chemicals and errant vehicles. Splashblock separates landscaped areas from the roadway curb and/or median cover. It also provides a “safe zone” for maintenance personnel. Below are criteria associated with this element:
- (a) The width of the splashblock shall be three feet (3') for major arterial streets in accordance with details in the *Roadway Design and Construction Specifications*.

- (b) Splashblock adjacent to maintenance access areas shall be constructed to accommodate mower access if landscaped areas include turf.
 - (c) Splashblock shall be integrally colored with Davis Color: Omaha Tan or approved equal and shall typically have a continuous nine and one-half feet (9.5') inside radius where it meets the median cover.
 - (d) Splashblock shall be fiber-reinforced and match finish and design mix specifications for the city standard curb and gutter. Control joints in concrete splashblock shall be ten feet (10') on center and match ten feet (10') curb and gutter joints.
 - (e) Splashblock may be slip-formed but must meet all quality standards associated with traditional hand-forming methods.
 - (f) Alternative splashblock designs and/or concrete colors shall not be used unless approved by PROS.
- (5) Soil Preparation – Soil preparation is the practice of adding organic soil amendments and ensuring appropriate drainage so that landscaped areas have a soil environment that promotes plant health. Below are criteria associated with this element:
- (a) Compacted subgrades shall effectively drain. An underdrain trench and below-grade drainage system shall be provided where drainage rates are unacceptable.
 - (b) Utilities, particularly those installed at shallow depths, can be problematic for plant growth. New utilities are discouraged from being located within the landscaped medians, especially in areas with plant material, including turf. Utilities of any kind shall not be installed in medians unless approved by PROS.
- (6) Trees – No additional trees shall be planted in existing or new medians; only existing trees will be preserved. Where there are existing trees in medians, they are to be preserved and set up on a drip irrigation system.
- (7) Xeric Shrubs and Perennials – Water conserving xeric shrubs and perennials shall be incorporated into median design to provide varying seasonal interest and color and to break up large expanses of decorative rock and crusher fines.
- (a) **Plant Selection** – Acceptable shrub and perennial species shall be approved by PROS on a case-by-case basis. The city *Xeriscape Plant List*, latest edition and plant schedules from recently installed median landscapes shall be used for plant selection guidance. Additionally, PROS will review proposed plant species for compatibility with harsh conditions associated with median plantings, and decisions will be made, in part, based on plant material that has demonstrated an ability to survive and thrive in landscapes being maintained by PROS.

- (b) Shrub and perennial plantings should be located in a random and dispersed manner.
 - (c) Plant material shall meet the following plant coverage percentage per linear foot of median:
 - (i) Perennials, shrubs, and grasses should cover an average total of no more than twenty (20) plants per one hundred (100) linear feet of median. If medians are wider than the standard twenty-six feet (26'), the Director of PROS may determine, at his/her sole discretion, that another treatment may be acceptable.
 - (d) Large shrubs should be avoided, as they generally do not conform to city sight distance requirements.
 - (e) When there are conditions of plant beds – they shall be a minimum of four feet (4') wide. Generally, shrub plantings should make up a greater portion of the planting beds than perennial plantings.
 - (f) Accent planting beds incorporating annual plant species may be permitted only in key areas of landscaped medians that are to be maintained by a non-city entity.
- (8) Sight Distance – An area of visibility free of obstructions at a corner formed by intersecting streets, sidewalks and trails.
- (a) All aspects of landscaped median design shall take into account the provision of adequate sight distance as per the Public Works Department's standards.
 - (b) Design elements, especially the selection of plant material and the arrangement of planting areas and strips shall be such that they do not obstruct visibility at corners, intersections, turning lanes and median cuts (walkways, bike lanes, trail crossings).
- (9) River Rock / Cobble, Crusher Fines and Boulders – A material (washed river rock) that is used sparingly as mulch and as an accent border (1' wide) in medians that do not have a splashblock. This material is to always be used over weed barrier fabric.
- (a) The use of river rock or cobble directly adjacent to splashblock shall not be permitted.
 - (b) Large expanses of river rock or cobble without plantings shall not be permitted. It is only acceptable to not have plant material when the river rock is used as a border of the medians without splashblocks.
 - (c) Crusher fines and colored rock will be used in addition to river rock to create the desired look of a natural river bed.

- (d) Medium and large sized river boulders will be dispersed randomly throughout the medians. Medium boulders must be set back at least four feet (4') from the flowline and large boulders must be set back at least six feet (6') from the flowline. The maximum reveal height of all boulders shall not exceed fifteen inches (15"). Boulders shall not exceed five (5) per one hundred (100) linear feet of median.
- (e) **List of Materials:**
- (i) 3/4" Wyoming Red Rock: Pioneer Sand, 463 Airport Blvd., Aurora, CO, 80011, 303-340-1440 OR APPROVED EQUAL, submit sample for approval.
 - (ii) 4"- 8" White River Cobble: Pioneer Sand, 463 Airport Blvd., Aurora, CO, 80011, 303-340-1440 OR APPROVED EQUAL, submit sample for approval.
 - (iii) 1-1/2" 3/4" Local River Rock: Pioneer Sand, 463 Airport Blvd., Aurora, CO, 80011, 303-340-1440 OR APPROVED EQUAL, submit sample for approval.
 - (iv) 3/4" Black Granite: Pioneer Sand, 463 Airport Blvd., Aurora, CO, 80011, 303-340-1440 OR APPROVED EQUAL, submit sample for approval.
 - (v) River Boulders: Jensen Sales Company, 8980 S. Santa Fe Dr., Littleton, CO, 80125, 303-791-4250, OR APPROVED EQUAL, submit sample / photo for approval.
- (10) Wood Mulch – A material that is used in planting beds with weed barrier to help retain moisture, mitigate temperature extremes and discourage weed growth. All shrubs and perennials outside of planting beds are to be planted in this material and material is to extend six inches (6") past edge of planting area. Wood mulch is to be five inches (5") thick in all areas that it is used.
- (a) A five-inch (5") thick layer of wood mulch is the preferred material in planting beds and shall be required in all groundcover or perennial areas and around the base of trees in planting beds. A circular, porous recycled rubber mat (color: brown) shall be installed around trees located in turf areas.
 - (b) Weed barrier shall be used under wood mulch.
- (11) Other Design Criteria:
- (a) Generally, medians shall be graded with a minimum two percent (2%) slope on all concrete and landscape areas.
 - (b) Positive drainage shall be maintained in all areas.
 - (c) Slopes in median landscape areas greater than five-to-one (5:1) shall be noted on plans and may require additional design treatments.
 - (d) Landscape areas with a slope of greater than four-to-one (4:1) shall not be permitted.

(12) Special Standards:

(a) In the past, landscaped medians along various stretches of city streets (i.e., Colfax Avenue, Alameda Parkway, Buckley Road/Airport Boulevard, etc.) were constructed using design criteria that differ from current standards. When modifications to these non-conforming median designs or any new median segments are proposed adjacent to or in reasonable proximity to them, all new work should match existing conditions. The determination as to whether new work shall conform to prior design standards shall be made by PROS. Requests shall be reviewed and approved by PROS.

(13) Special Design Elements – In addition to the standard design elements, the developer may wish or be required to provide special design elements in the median design. Special design elements include: 1) elements that reinforce or identify a specific neighborhood or sector of the city and 2) design standards that differ substantially from those outlined in this manual. Special design elements must be reviewed and approved by PROS. PROS staff may require that a median be maintained by a non-city entity if such responsibility is warranted due to a special design that could necessitate special maintenance measures and levels of service that deviate from general practice.

6.16 NATURAL & CONSERVATION AREA CRITERIA

A. **GENERAL DESCRIPTION** – Natural and conservation areas serve a variety of community objectives such as offering refuge from the built environment, retaining unique aesthetic qualities, preserving animal and plant habitats, supporting the function of natural systems, and ensuring access to open space for residents to take advantage of the lands' secondary benefits. Although this type of open space favors the preservation of the natural environment, it also functions to directly serve the public by providing opportunities for nature-based, unstructured, low-impact recreation activities. Protected and restored natural areas also provide opportunities for residents to connect with and learn about the outdoors as well as foster respect for nature and the environment.

B. **LOCATION CRITERIA** – Natural resource availability, ecological significance, environmental restrictions, development constraints, resource education opportunities, and recreation capabilities are the principal factors in determining the location of natural & conservation areas. Land that can't be built upon often dictates where open spaces are located more than do the other criteria, but when opportunities for multiple criteria to be met at the same location, their symbiotic relationships can enhance the overall value of an open space to a community.

C. **DEVELOPMENT CRITERIA:**

(1) Natural & conservation area development is limited to appropriate passive recreational purposes, such as hiking, nature study, and photography. In general, open spaces shall be preserved and managed in a natural or naturalized condition. Development of these areas for passive recreational

purposes will be managed to preserve the integrity of the surrounding resources. Final facilities selection and location requires PROS approval.

- (2) All efforts should be made to preserve the inherent value of natural features to protect and enhance natural systems.
- (3) Development in these areas should be limited, sensitive to site characteristics and designed to accommodate use in ways appropriate to sustaining the native ecosystems.
- (4) Signage and activities should take advantage of interpretive opportunities.

D. DESIGN REQUIREMENTS:

- (1) PROS Consultation – Coordination with PROS is necessary to define appropriate programmatic elements and to delineate the lands best suited to satisfy the functional needs of the open space.
- (2) Specifications & Details – If the site will be city owned, the improvements within the open space should conform to PROS' standard specifications and details but will have custom design components sensitive to site characteristics and designed to minimize disturbance to special resources.

6.17 CULTURAL & HISTORIC SITE CRITERIA

- A. **GENERAL DESCRIPTION** – Cultural and historic sites are lands set aside for the preservation, enhancement, and use of buildings, structures, sites and areas that are unique and irreplaceable assets that are reminders of the city's cultural and architectural past. These sites protect the historic and cultural features of interest, include open space as a backdrop providing historical context, and offer opportunities for compatible outdoor recreation activity. The cultural/historic resources themselves can be the focus of educational programs to foster knowledge of the city's heritage and cultivate civic pride, but the surrounding open space can be important areas for the protection of natural resources as well.
- B. **LOCATION CRITERIA** – Resource availability and opportunity are the primary factors in determining the location of cultural and historic sites. Examples of this type of site include a historic farmstead, remnant historic landscapes, and archaeologically-significant sites such as a Native American encampment.
- C. **DEVELOPMENT CRITERIA:**
- (1) An evaluation may be needed to authenticate a site's history or to determine the feasibility of restoring/maintaining the site or its structures for public use.
 - (2) All efforts should be made to preserve the historic and cultural value of the site. Development in these areas should be limited and sensitive to the preservation of the cultural or historic elements of the site.

- (3) Signage and activities should take full advantage of interpretive opportunities without impacting the integrity of the resource.

D. DESIGN REQUIREMENTS:

- (1) PROS Consultation – Coordination with PROS is necessary to define appropriate programmatic elements and to delineate the lands best suited to satisfy the functional needs of the open space.
- (2) Specifications & Details – If the site will be city owned, the improvements within the open space should conform to PROS' standard specifications and details but will have custom design components sensitive to site characteristics and designed to minimize disturbance to special resources.

6.18 GREENWAY & GREENBELT CRITERIA

A. GENERAL DESCRIPTION – Greenways and greenbelts are linear swaths of land (developed, natural, or both) that are used as trail corridors and to join park or open land sites together:

- (1) A greenway is a linear corridor that connects and protects or enhances natural, scenic or cultural features that have been identified as interesting, important, unique or special in some way. A greenway may sometimes be set aside solely for the purposes of preserving open space and conserving natural features and may not always contain a trail or permit public access. Trails in greenways facilitate both recreation and transportation within the corridor. Greenways can be wildlife corridors as well as scenic routes between population centers and points of interest. They are most likely to occur along major drainages, utility corridors, arterial roadways and other swaths of new corridor created simply to provide connections.
- (2) Greenbelts are similar to greenways in that they too are linear swaths of connected open space, but they are typically less wide and their lengths are shorter than a greenway. A greenbelt is also less likely than a greenway to be associated with another special feature, though they may accommodate wildlife movement/habitat nonetheless.

B. DEVELOPMENT CRITERIA:

- (1) The principal function of a greenway/greenbelt should govern the intensity of its use, development and land management.
- (2) All efforts should be made to preserve the inherent value of greenways/greenbelts to protect and enhance natural systems, plants and animals.
- (3) Coordination with PROS is necessary to mutually define the purpose(s) of the greenway and the lands and features that are critical to protect to meet the greenway/greenbelt objectives. Its principal function should govern the intensity of its use, development and land management practices. For example, if the

purpose of a greenway/greenbelt is mainly to serve as a wildlife corridor, then public use and trail development may need to be restricted or prohibited based on the sensitivity of the habitat required by the animal species that will pass through.

C. DESIGN REQUIREMENTS:

- (1) PROS Consultation – Coordination with PROS is necessary to define appropriate programmatic elements and to delineate the lands best suited to satisfy the functional needs of the open space.
- (2) Specifications & Details – If the site will be city owned, the improvements within the open space should conform to PROS’ standard specifications and details but will have custom design components sensitive to site characteristics and designed to minimize disturbance to special resources.
- (3) High Line Canal – Under the terms of a lease agreement and recreational operating plan with the Denver Water Board, PROS operates, maintains, and manages the High Line Canal corridor through Aurora for trail and greenway purposes. Any proposed construction, physical improvement, or modification of existing conditions within the canal property must be reviewed and approved by the Denver Water Board and High Line Canal Conservancy. Plans must comply with the requirements of that agency prior to acceptance by PROS. All communication, correspondence, and transmittal of plans and proposals shall be directed to the Denver Water Board by PROS staff in order to obtain supplemental written authorization to proceed.

6.19 CRITERIA FOR OPEN SPACE RESOURCES

A commonality among the different types of lands categorized as open space in previous Sections 6.16 through 6.18 is that they are essentially undeveloped lands, except where cultural features are preserved or where minimal improvements are made to provide access for low-intensity and dispersed recreation and for maintenance purposes. Grouped below are criteria which address basic design principles regarding conservation of these important open space resources to the city.

- A. STORM DRAINAGE** – In the majority of cases, storm drainage improvements are closely tied to adjacent parks and open spaces. Impacts are related to wildlife habitat, ecosystems in natural areas, and aesthetics and use in developed areas.

Design of all storm drainage facilities shall be coordinated with PROS staff to minimize potential impacts on natural resources and to determine materials and aesthetic character of any structures. Meeting with PROS staff early in the design process, even prior to making design decisions related to drop structures, detention basins and disturbances to significant natural areas can save developers time and often expense related to the design and construction of these elements.

- (1) Design Criteria – General design criteria for storm drainage features are:
 - (a) Preservation of areas which are considered significant natural resources or ecosystems. These may be areas with important wildlife corridors,

prairie, wetlands, riparian vegetation, extensive tree cover or with other significant plant communities.

- (b) Use plant materials that are either native or non-invasive to the site or which will have a lesser visual impact. In preservation or naturalized areas no granite boulder construction shall be used. Acceptable alternative construction methods are:
 - (i) Sheet piling.
 - (ii) Vertical concrete.
 - (iii) Soil cement.
 - (iv) Custom concrete simulating native stone.
- (c) If concrete is used, an integral color additive may be used to match existing soil color.
- (d) If a drop structure is within a developed landscape, granite may be an acceptable material but the developer must work with PROS staff to coordinate design.
- (e) Revegetate and restore disturbed areas with plant material native to the area. Adhere to PROS approved seeding and planting procedures.
- (f) If a crossing of a drainage is required for trail/maintenance purposes, the design of the crossing must be coordinated with PROS staff early in the design process. Staff shall help determine whether a bridge or a low water crossing is needed and to help establish parameters for its final design. Some general guidelines that may be considered in the decision-making process include:
 - (i) What sort of flow does the drainage typically experience at the crossing location during a flood event? If there will be a high frequency of potential inundation and/or the volume of flood flows is extreme, a low water crossing is likely not a practical choice.
 - (ii) Does the crossing serve a regional trail or critical connection to a regional trail? If so, a bridge shall be required.
 - (iii) What is the service area of the drainage crossing? If the trail crossing will be a key link between major destinations or is providing strategic access to a land use such as a school, a bridge shall be preferred.

B. NOXIOUS WEEDS – PROS has placed a high priority on the management of noxious weeds within city open space areas. In concurrence with the State of Colorado, Department of Agriculture, PROS has set similar goals regarding the prevention of exotic and invasive plant species introduction, eradication of invasive plant species where practicable, and containment and management of established invasive species.

- (1) Management Criteria – PROS has adopted the state’s Noxious Weed Management Program as the approved methodology for managing weeds within city property. This program identifies plants defined as noxious weeds and places them in to one (1) of three (3) categories: List A Species, List B Species, and List C Species. Weeds are managed differently depending on

which species list they fall under. Contact PROS staff for additional information, or go to the following link to learn more online:
www.colorado.gov/pacific/agconservation/noxious-weed-species.

C. **SEEDING, REVEGETATION & RESTORATION** – Naturally vegetated lands within the city are typically extremely ecologically sensitive. Any negative influences to the physical character of open space from development or construction activity are likely to cause impacts to natural resources in the form of ecological degradation, erosion and native habitat destruction. Proposed development or construction of any kind shall endeavor to maintain open space in a natural undisturbed state to the greatest extent practicable and where that cannot be achieved, the following design criteria for restoration shall apply:

- (1) Where development construction is planned to occur, the applicant shall plan and design the development site in a manner consistent with PROS' policies set forth in this manual.
- (2) While all possible measures shall be taken to leave areas designated for preservation in an undisturbed condition in order to protect any natural ecosystems, PROS understands that development may require the reseeded, revegetation or restoration of open space that existed on the subject development property.
- (3) City Ownership – Seeding and revegetation within areas to be city owned must be in accordance with PROS' standards and specifications.
 - (a) PROS has developed ecologically appropriate seed mixes, based on soil analysis and other factors, for use by developers to reseed and restore grass open space areas within property owned and maintained by the city. The seed mix shall be determined based on the *Aurora Native Grass Seeding and Restoration Guidance Manual*.
 - (b) These areas will be maintained for a three (3) year warranty & maintenance period (refer to Section 8.3.1 of this manual) to ensure native seed establishment by the developer. The warranty period may be extended until acceptable vegetative density is achieved.
 - (c) Contact PROS staff for additional information regarding policies and specifications for native seed restoration.

D. **NATIVE PLANTING** – Areas designated as open space, natural areas, preservation areas and stream corridors within developments shall comply with PROS' standards for native plantings. PROS, as an integral component of the city's plan approval process, reviews all planting/landscape plans for compliance with city native planting policies. The following criteria shall be incorporated into the development of native area plantings:

- (1) Planting schedules proposed for native areas within developments shall be derived only from plant species found in native areas surrounding the proposed native area in question. PROS staff shall review all proposed plant material for conformance with this criterion. Recommendations shall be given as a part of development review comments as guidance for revisions to planting plans.

- (2) Planting plans shall show all existing vegetation and grades and shall indicate whether water from an adjacent drainage or ground water is available.
- (3) The need for irrigation, whether temporary or permanent, shall be determined on a site-by-site basis. In most cases, some source of temporary irrigation (for 3-5 years) will be required to ensure establishment of plant material.
- (4) Grass seed mixes for revegetation shall be site-specific. Refer to the previous Section 6.19.C.
- (5) Requirement for perennials and other low growing woody species is determined on a site-by-site basis.
- (6) Other native plants will be considered if it can be proven that they exist in adjacent similar native landscapes. Introduction of non-native or horticultural variations of native plants is generally not acceptable.
- (7) Contact PROS staff for additional direction regarding native plantings.

E. **DELINEATION OF MAINTENANCE AREAS** – Measures shall be taken to delineate areas of maintenance responsibility. These different responsibilities include city versus non-city (i.e., metropolitan district or homeowner’s association areas) as well as possibly delineation of areas maintained by different city maintenance crews. The assignment of maintenance responsibilities, possibly requiring property lines to be shifted or proposed ownership to be changed, shall be determined as early in the planning process as possible.

The following are considered acceptable methods of maintenance responsibility delineation although other ideas may be submitted for consideration by PROS staff:

- (1) Vertical posts or markers.
- (2) Concrete curb or edger.
- (3) Concrete trail.
- (4) Fencing (appropriate to the site).

6.20 TRAIL & PATH CRITERIA

A. **GENERAL DESCRIPTION** – Trails include three (3) general types: neighborhood connections, community connections and regional trails. Each type complements the others and together they form an interconnected pedestrian and bicycle network linking parks and open spaces with communities throughout the city.

- (1) Regional Trails – These trails serve as the backbone of the city-wide trail network because they provide longer distance connections to major, regionally-important destinations (such as large urban parks and significant open space facilities within the city and beyond its borders in neighboring jurisdictions).

Regional trails often coincide with a greenway or utility corridor and may follow a prominent natural or man-made feature, such as a creek, drainage, canal or arterial roadway.

- (2) Community Connector Trails – These trails connect residential areas to places that serve as significant generators and points of interest to residents from not only the immediate neighborhood but the larger community as well. Community connections generally serve as “second order trails” that collect users from neighborhood connections and then act as a principal route to community-based destinations that are more distant from their homes. They provide connections to destinations generally within a 2-mile service area radius (such as neighborhood and community parks, schools, recreation or community centers and regional trails). Community connections often coincide with a greenbelt or greenway.
- (3) Neighborhood Connector Trails – These trails provide connections to destinations within a neighborhood. They generally serve as routes for residents to travel by foot short distances from their homes to local, nearby destinations. Neighborhood connections often coincide with a greenbelt.

B. TRAIL WIDTHS, SETBACKS & SURFACING REQUIREMENTS:

- (1) Regional Trails – These trails shall be no less than ten feet (10') in width, shall be a minimum of thirty feet (30') from property lines and fences, and shall be concrete (except for the Sand Creek Greenway Trail and Triple Creek Trail which have a crusher fines surface). The only exception to the minimum width standard is the High Line Canal Trail which is eight feet (8') wide.
 - (a) The above dimensional requirements and setbacks result in a total minimum corridor width of seventy feet (70') for a regional trail.
- (2) Community Connections – These trails shall be no less than eight feet (8') in width, shall be a minimum of twenty feet (20') from property lines and fences, and shall be concrete.
 - (a) The above dimensional requirements and setbacks result in a total minimum corridor width of forty-eight feet (48') for a community connector/trail.
- (3) Neighborhood Connections – These trails shall be no less than six feet (6') in width, shall be a minimum of ten feet (10') from property lines and fences, and may be concrete or soft surface depending on location and maintenance.
 - (a) The above dimensional requirements and setbacks result in a total minimum corridor width of twenty-six feet (26') for a neighborhood connector/trail.

- C. ADA** – All trails shall meet ADA regulations. The longitudinal grade shall not exceed five percent (5%). The cross slope shall not exceed two percent (2%). The slope in any direction shall not exceed five percent (5%). In areas not conducive to accommodating these longitudinal grade and cross slope requirements, PROS will

make a determination if departure from these criteria is warranted based on the most current version of the *Accessibility Guidelines for Outdoor Developed Areas* prepared by the Architectural and Transportation Barriers Compliance Board (Access Board). These guidelines acknowledge that under certain circumstances exceptions to the ADA regulations should be granted, thereby allowing steeper trails and deviations from other trail design standards. Generally, the guidelines allow the following running slopes: 8.33% maximum for 200 feet (200') maximum; 10% maximum for 30 feet (30') maximum; and 12.5% maximum for 10 feet (10') maximum. If a departure from the maximum 5% and 2% standards is proposed, PROS staff should be consulted early in the design of the trail to determine whether an exception is warranted.

- D. **HARD SURFACE** – Hard surface trails shall be a minimum five-inch (5") depth concrete with fiber mesh reinforcement. If a trail is used for other purposes besides recreation, such as serving secondarily as an access route for vehicles unrelated to trail maintenance and patrol, the concrete shall be a minimum of six inches (6") in depth with fiber mesh reinforcement.
- E. **SOFT SURFACE** – Soft surface (crusher fines or recycled concrete passing a similar sieve size) trails shall be a minimum six inches (6") depth over weed barrier fabric. Soft surface trails may be used for neighborhood connections or less significant trail connections but may not be used for school access routes. They may not be within the 10-year floodplain or used in locations that require snow removal, such as fire access lanes. If the grade exceeds five percent (5%), soft surface trails shall not be an option.
- F. **RETURN RADIUS** – If the trail is hard surface, a twelve-foot (12') radius shall be at all trail intersections. If the trail is crusher fines, a ten-foot (10') radius is acceptable. If the trail is used as an access drive for utilities or drainage maintenance, the radius shall increase to twenty feet (20'). If the trail serves as a fire lane access, it needs to meet the Fire Department's minimum radius standards.
- G. **FLOODPLAIN** – Trails shall be above the 100-year floodplain or, if not a regulated floodplain, the 100-year water surface elevation as identified in a city-approved drainage master plan or study. A trail may encroach into a floodplain to cross drainage channels or to respond to other site-specific circumstances related to connectivity and design objectives, as approved by PROS on a case-by-case basis. In cases where trails are located below the 10-year floodplain or water surface elevation, they shall be protected using buried rip-rap, walls, or other means of stabilization.
 - (1) The land area associated with trail corridors which pass through floodplains shall not be eligible for land dedication credit.
 - (2) Where residential development is dissected from park, open space and trail facilities by drainage corridors, PROS may require a pedestrian bridge or low water crossing in order to create connectivity and meet minimum service radius standards.

- H. **CLEAR ZONE** – All trails shall have a two-foot (2') wide shoulder or clear zone on both sides of the trail to allow for recovery from accidents or passing. The clear zone shall be at the same grade as the trail (with maximum 2% cross slope) and be free of obstructions.
- I. **STREET CROSSINGS / GRADE SEPARATION** – While trails generally provide for physical separation between trail users and motor vehicle traffic, they inevitably must intersect with streets, resulting in the need to provide connectivity between these two types of transportation facilities coupled with a need to also design their junctions so that operations and safety are maximized and the number of conflicts are minimized. Considering the complexity of design variables, including diverse trail user characteristics and varied traffic operational conditions, the best approach for determining the design requirements of a trail-street crossing is to fully examine site-specific information and to apply sound planning and engineering judgment on a case-by-case basis.

PROS' objective is to protect the safety of the public by minimizing trail user opportunities for exposure to the risks associated with vehicular conflicts. The following principles shall not be interpreted as precise requirements but are instead meant to serve as general guidelines for the planning and design of trail-street crossings:

- (1) Where a regional trail intersects with an arterial street, a grade-separated crossing shall be required (with either a bridge or underpass structure). Clearance for pedestrians and bicyclists shall be ten feet (10') in height and fourteen feet (14') in width. If horses are permitted, clearance shall be twelve feet (12') in height and fourteen feet (14') in width. The bottom of a box culvert underpass and trails affected by drainage flows under bridges shall have a two percent (2%) cross slope, and the trail surface should be above the 5-year developed flow depth at a minimum (above the 10-year developed flow depth is preferred).
- (2) If a grade-separated crossing for a regional trail and arterial intersection is not feasible, a signal-controlled at-grade crossing shall be provided as an alternative, either designed as a midblock crossing or co-located with the crosswalk of a T-intersection or 4-legged intersection for streets.
 - (a) The feasibility of providing grade-separation for trails shall be determined in accordance with the parameters outlined in this Section 6.20.I.
 - (b) This same crossing treatment should apply to street crossings if as an interim condition that will ultimately be upgraded to a grade-separated crossing.
- (3) Where any classification of street intersects a neighborhood connection trail or a community connection trail, the need for and benefits of a grade-separated crossing shall be considered. If a grade-separated crossing is not feasible, an at-grade crossing that adequately protects the trail users shall be provided as an alternative, and a signal-controlled crossing shall be preferred in these instances. If possible, the at-grade crossing should be made at street intersections with crosswalks or be located a safe distance from intersections when a mid-block crossing is necessary.

- (4) If warrants are not met for the installation of a signal or pedestrian activated light where any trail and street intersect at-grade, alternative regulatory traffic control devices shall be used to restrict vehicular movements and protect trail users. At all crossings, trail user traffic shall be controlled with a regulatory “stop” sign or other appropriate traffic control device located along the trail, which shall be supplemental to any devices used to control the street traffic.
- (5) Site-specific improvements and crossing treatments recommended by PROS staff, City Public Works Department, and/or the Colorado Department of Transportation shall be incorporated, as appropriate, into all trail-street crossing designs.

The application of a specific crossing solution will be determined following analysis of each crossing site and the trail circumstances and needs unique to that location. This is best done at the site planning/engineering stage of a project (not at the time of conceptual or master planning), when there is sufficient, site-specific information available to evaluate the most practical way to accommodate both trail and street needs without unduly compromising trail user safety.

These “street crossings criteria” strongly encourage trail grade-separations, especially for new street construction. Potentially, an at-grade crossing may be acceptable if it can be clearly demonstrated as to why a grade-separation is not feasible. Demonstration of the practicality of providing a grade-separated crossing shall factor in projected conditions for traffic increases and the potential for greater trail use in the future. PROS staff shall, in its sole discretion, decide whether an at-grade crossing is acceptable based on a review that takes into account the cumulative impact of all variables, positive and negative, which influence the safety and functionality of a proposed crossing solution.

J. **ACCESS PREVENTION** – Gates (per standard details) may be required where regional trails or community connector trails intersect with or terminate at roadways. Fencing may also be necessary to provide access control. Access protection elements (i.e. gates, fencing, etc.) shall be designed to prevent motorized vehicles from accessing non-motorized trails and open space areas. The need for access prevention will be evaluated and any requirements shall be determined on a case-by-case basis by PROS staff.

- (1) All gates must be lockable. If the trail is jointly used as an access drive for utility or drainage maintenance purposes or serves as a fire lane access, Aurora Water and/or Fire Department approved locks must be used. PROS will provide locks for all other uses.

K. **CITY OWNERSHIP OF TRAILS** – There are special requirements applicable to trails that are city owned and maintained:

- (1) Hard Surface – If the trail is also used as a utility access drive or maintenance road for another city department, the concrete must be able to hold the maximum weight of utility and maintenance vehicles. Where the trail is within a fire lane, the pavement design shall meet the requirements of the Fire Department. The pavement design shall be decided on a case-by-case basis and will vary from site to site depending on soils and weight loads.

- (2) Street Crossings / Grade Separation – If a trail intersects a street mid-block PROS' first preference is a grade-separated crossing using a bridge structure that allows the trail to pass under the street.
- (3) High Line Canal – Under the terms of a lease agreement and recreational operating plan with the Denver Water Board, PROS operates, maintains, and manages the High Line Canal corridor through Aurora for trail purposes. Any proposed construction, physical improvement, or modification of existing conditions involving the canal trail must be reviewed and approved by the Denver Water Board and the High Line Canal Conservancy. Plans must comply with the requirements of the High Line Canal Framework Plan and Denver Water regulations prior to acceptance by PROS. All communication, correspondence, and transmittal of plans and proposals shall be directed to the High Line Canal Conservancy and Denver Water Board by PROS staff in order to obtain supplemental written authorization to proceed.

L. INTERNAL PATHS – Internal paths are trails at parks and open space areas that provide access to uses and facilities within a site but are not designated as part of the larger trail system of the city. The same criteria for trails generally apply to internal paths, but slight differences in the standards are presented below:

- (1) ADA – If an internal path cannot be less than five percent (5%) longitudinal grade, PROS will decide if a steeper longitudinal slope or steps are acceptable. Paths are critical for meeting accessibility requirements within a park or open space area because all facilities should have a primary accessible route of travel.
 - (a) PROS may determine that a steeper longitudinal slope is acceptable so long as an accessible route has been provided elsewhere on-site to all amenities, primarily accessible parking, inclusive play equipment, and seating areas.
 - (b) When ADA compliance is not feasible, appropriate signage shall be installed to inform users that the path is steep and to advise on the use of alternative accessible routes.
- (2) Return Radius – Hard surface paths shall have either concrete triangles with four-foot (4') wide sides or twelve-foot (12') radii at all trail intersections.
- (3) Soft Surface:
 - (a) Soft surface paths shall be crusher fines or recycled concrete passing a similar sieve size at a minimum of six-inch (6") depth over weed barrier fabric.
 - (b) If the longitudinal grade exceeds five percent (5%), a soft surface path shall not be an option unless the surface is conducive to being stabilized using additives.
 - (c) Soft surface may be used for connections to neighborhoods and other adjacent land uses but not if the path serves as a school access route.

- (d) If stabilized with additives, soft surface paths can be used in locations where they need to be plowed.
- (4) Floodplain – Paths shall be above the 100-year floodplain or, if not a regulated floodplain, the 100-year water surface elevation as identified in a city-approved drainage master plan or study. A path may encroach into a floodplain to cross drainage channels or to respond to other site-specific circumstances related to connectivity and design objectives, as approved by PROS on a case-by-case basis. In cases where paths are located below the 10-year floodplain or water surface elevation, they shall be protected using buried rip-rap, walls, or other means of stabilization.
- (a) If stabilized with additives, soft surface paths can be located within the 10-year floodplain or 10-year water surface elevation.
- (5) Street Crossings/Grade Separation – Where a path intersects a street having more than two vehicular travel lanes, a grade-separated crossing that complies with the criteria for trails shall be preferred:
- (a) If a grade-separated crossing is not feasible, the path shall cross the street using a signalized crosswalk or pedestrian activated light, and path user traffic shall be controlled with a regulatory “stop” sign or other appropriate traffic control device. At-grade path crossings should be located at street intersections or be set back sufficiently from intersections, in the case of mid-block crossings, to minimize conflict with vehicular traffic movements.
 - (b) Site-specific improvements and crossing treatments recommended by PROS staff, city Public Works Department, and/or the Colorado Department of Transportation should be incorporated, as appropriate, into all path-street crossing designs.
 - (c) The application of a specific crossing solution will be determined at the site planning/engineering stage of a project following analysis of each crossing site and the circumstances and needs unique to that path location.
- (6) City Ownership – Special standards for internal paths that are city owned are as follows:
- (a) A twelve-foot (12’) turning radius shall be required on all paths.
 - (b) Primary park access paths shall be concrete. Crusher fines (or other soft-surface material) may be permitted on secondary or tertiary routes on a case-by-case basis.
 - (c) Crusher fines shall only be used on slopes less than five percent (5%) longitudinal grade.
 - (d) Paths shall be eight feet (8’) minimum width, except those that serve as a primary route for maintenance of playgrounds, shelters, and vault toilets shall be ten feet (10’) wide.

6.21 LANDSCAPE-RELATED CRITERIA

- A. **GENERAL DESCRIPTION** – How extensively a park can be landscaped and what materials can be used shall be determined, in part, by who ultimately will be responsible for taking care of it. If a park is being constructed for the city to own and maintain, landscaping requirements are more prescriptive because there is less freedom in the way the park can be designed as well as less flexibility in the landscape materials that can be used in it. The intent of these landscape-related criteria is not to stifle design creativity or to force uniformity in the parks system. Rather, these criteria are based on PROS’ experience and preferences for treatments that will support park maintenance operations and create landscapes that will be durable and sustainable.

Criteria that apply across-the-board to all public parks regardless of ultimate ownership are presented first. Criteria which only apply to parks that the city will own and maintain are called out separately under the heading “City Ownership & Maintenance.”

- B. **TOPOGRAPHY / SLOPES** – A four-to-one (4:1) maximum slope in all areas credited toward park and open space shall be required. Graded areas shall be of smooth transitions free from ruts, depressions, and irregularities. The maximum slope requirement may vary in natural areas to reduce grading, preserve topography, or protect existing natural features and resources. The maximum distance of a sustained slope may, at the discretion of PROS, be limited. The decision to limit how far a slope may extend longitudinally will be based on an analysis of the ability to provide the required programmatic elements of the park and the collective impact that all surrounding slopes will have on the public use and function of the site.
- C. **TREE DIVERSITY** – All parks shall utilize a variety of tree species in order to provide a diverse urban forest which will not be devastated by an insect infestation or a disease. Any single species or cultivar shall not exceed ten percent (10%) of the proposed tree planting. Any one genus shall not exceed twenty percent (20%) and any one family shall not exceed thirty percent (30%) of the proposed tree planting. The existing tree population in the vicinity of the project should also be considered when selecting tree species. When approved by PROS staff, exceptions to these criteria will be allowed where justified (i.e., if the number of trees proposed is very low, if the design intent will be compromised, etc.).
- D. **COMPLIANCE WITH CITY CODE** – Park and open space land that is owned and maintained by a non-city entity shall conform to current City Code requirements.
- E. **IRRIGATION** – The developer shall pay for the tap, meter, etc. as well as tap fees charged by the city.
- F. **CITY OWNERSHIP** – Sites owned and maintained by the city have the following additional requirements:
- (1) Soil preparation:
 - (a) To ensure a growing medium for healthy plants, testing of existing soil shall be performed as required by PROS staff. Following soil sampling

and analysis results, the soil shall be amended according to lab recommendations with PROS' concurrence.

- (b) Soil shall be generally free of dead plant material and their root systems, weed seed, rocks and other debris.
- (c) Material in planting areas shall only be clean topsoil, with no construction debris or inorganic material. The depth and extent of topsoil and all material, including organic amendments, shall be approved by PROS.

(2) Turf:

- (a) All turf grass areas shall be designed to accommodate ease of maintenance. Concrete mow strips should be used at intersections of turf areas and vertical surfaces and between areas of differing maintenance practices (i.e., turf grass and native grass areas). A minimum clearance of eight feet (8') should be maintained between all vertical elements for mower access.
- (b) A Bluegrass blend shall be used in active, high-use areas.

(3) Native Grass – Native grasses shall be used for revegetation of native grass areas and in perimeter areas to buffer/transition park use areas from adjacent land uses. The seed mix shall be determined based on the *Aurora Native Grass Seeding and Restoration Guidance Manual*.

(4) Trees and Shrubs:

- (a) Plant material selection shall be in accordance with the latest editions of the city's xeriscape and native plant lists which identify trees and shrubs suited for Aurora. In accordance with city policy, water management and conservation measures are encouraged. PROS staff shall have final discretion to approve plant material selections.
- (b) Over-story deciduous, ornamental deciduous and evergreen trees shall be used where appropriate for shade and aesthetic effect. Evergreen trees shall not be planted in locations where they would shade walks, trails or roadways in the winter, causing icy conditions.
- (c) Whenever possible, trees shall be planted in mulched planting beds as determined by PROS staff.
- (d) Shrubs, perennials and annual beds shall be used sparingly. Planting beds for enhancement of signage, accent beds, screening and focal areas shall be approved by PROS staff on a case-by-case basis:
 - (i) When required by a regulatory agency which has authority over a project, new trees and shrubs may be permitted within natural areas. In such cases, new trees and shrubs shall be watered by hand, irrigated by a temporary system or planted per an alternative method approved by PROS.

(5) River Rock/Cobble:

- (a) Large expanses of river rock or cobble without plantings shall not be permitted.
- (b) River rock or cobble may be used sparingly in planting beds with weed barrier. Cobble may be used as a one-foot (1') wide border around planting beds containing wood mulch. An approved pre-emergent herbicide shall be applied on top of river rock/cobble.
- (c) River rock or cobble shall not be permitted in perennial planting areas unless used as a border.

(6) Wood Mulch:

- (a) A three-inch (3") thick layer of wood mulch is the preferred material in planting beds. It shall be required in all beds containing groundcovers, perennials, shrubs and trees. A circular ring of wood mulch shall be installed around trees located in turf areas.
- (b) Weed barrier shall not be used under wood mulch. An approved pre-emergent herbicide shall be applied on top of wood mulch.

(7) Irrigation:

- (a) The irrigation system shall require a separate tap and water meter. (Tap fees and the cost of the tap, meter, etc. is part of the cost of construction borne by the developer.)
- (b) All landscaped areas, including turf and plant beds, shall be irrigated by a fully automatic system.
- (c) All turf shall be irrigated by spray heads.
- (d) All trees, shrubs, groundcovers and perennial beds shall be irrigated by subsurface drip tubing.
- (e) Turf areas shall be zoned separately from planting beds and tree plantings.
- (f) The irrigation system shall be designed and installed to minimize water spray and runoff onto adjacent pavement.
- (g) The system shall be designed such that all watering may be accomplished after 11:00 p.m. and before 5:00 a.m.
- (h) The automatic system shall be controlled by radio communication linked to PROS' central irrigation computer. (Note: If a landscaped median is maintained by a metropolitan district, homeowner's association, etc. rather than by PROS, the irrigation system need not be operated by a controller that is compatible with PROS' central computer system.)

- (i) The irrigation system shall be comprised of materials and components listed in PROS' standard irrigation equipment list (refer to Appendix G). Installation shall be in accordance with PROS' specifications and standard details.

6.22 FACILITIES & PROGRAMMATIC ELEMENTS CRITERIA

- A. **GENERAL DESCRIPTION** – This section describes design criteria that must be accounted for in the provision of facilities and programmatic elements within public parks. It is organized like the previous section, whereby the requirements apply universally to all parks unless they are presented under the heading of “City Ownership,” in which case those criteria apply only to parks owned and maintained by the city.
- B. **PLAYGROUNDS** – The intent for playground standards is to provide exciting, unique, progressive, and safe play spaces for children of all ages and abilities.
 - (1) **Inclusive Play Features** – Playgrounds within community parks and neighborhood parks shall provide a minimum of one (1) inclusive play feature with appropriate inclusive access:
 - (a) Inclusive play is defined as any equipment, structure, or design element which is specifically incorporated into a playground design to allow for cognitive, physical, sensory, and social play for all abilities. Examples of qualifying play features include but are not limited to:
 - (i) Accessible swings.
 - (ii) Accessible ziplines.
 - (iii) At-grade merry-go-rounds.
 - (iv) Sensory play equipment (multiple pieces).
 - (v) Accessible slides.
 - (b) Appropriate inclusive access shall include rubber surfacing which provides a direct connection from an accessible route to each inclusive play feature. Ramps for playground access must be less than 5% longitudinal grade and 2% cross slope and located adjacent to connected accessible infrastructure.
 - (2) Playgrounds shall be designed around a theme, which can be related to natural features, neighborhood character or imaginative story lines.
 - (a) Playgrounds may include themed, custom art or interpretive pieces as decorative elements or play events.
 - (3) Separate play areas shall be provided for pre-school (ages 2-5) and school-age children (ages 5-12).
 - (4) **Size** – The size of a playground shall be in relation to size and service area of the park. Minimum sizes are as follows:
 - (a) **Neighborhood Park** – 4000 square feet in area.
 - (b) **Community Park** – 8500 square feet in area.

- (5) Playgrounds shall be located at least fifty feet (50') from street rights-of-way, property lines and active park areas.
- (6) All playgrounds shall comply with the most recent version of the following guidelines and standards:
 - (a) American Society for Testing and Materials (ASTM).
 - (b) Consumer Product Safety Commission (CPSC).
 - (c) Americans with Disabilities Act Accessibility Guidelines (ADAAG).
 - (d) National Playground Safety Institute (NPSI).
- (7) City Ownership:
 - (a) **Inclusive Play Features** – City owned neighborhood parks shall include a minimum of two (2) inclusive play features and be integrated into both play areas for each age group of children to provide multiple experiences.
 - (b) **General** – Consultant should provide PROS with plans for playgrounds regarding design, equipment selection, edging, surfacing, trash receptacle and bench placement, and shade.
 - (c) **Play Equipment:**
 - (i) Only those play equipment manufacturers and lines currently approved for use may be installed in park properties. See Appendix D for the current list.
 - (ii) Equipment shall be of galvanized steel, aluminum or molded plastic construction. No wood structures or parts shall be permitted.
 - (d) **Fall surfaces:**
 - (i) All playgrounds shall have an accessible route and number of accessible play events as outlined in the ASTM and ADAAG documents.
 - (ii) Permitted safety surface is accessible, resilient rubber matting either in the form of tiles or poured-in-place material. See Appendix D for current list of approved suppliers.
 - (iii) Shredded bark mulch, pole peelings, and other wood products shall not be permitted in playgrounds maintained by PROS.
 - (e) **Hardscape:**
 - (i) Equipment footings shall be installed per manufacturer's recommendations by certified playground installers.
 - (ii) Playground retaining walls greater than thirty inches (30") in height shall be signed and stamped by a licensed Colorado engineer and must include a safety railing.
 - (f) **Playground Drainage** – All playgrounds shall have positive drainage. Subsurface drainage systems must be installed as dictated by site conditions.

- (g) **Playground Signage** – See paragraph J under this Section 6.22 for a description of typical playground signage. Signage should convey rules and regulations, age appropriateness, and guidelines for safe use related to the playground.
- C. **FENCING** – Several types of fencing are used within park and open space areas. The extent and type of interaction intended between the two adjacent properties determines the type of fence required in each application. PROS staff will assist in making the final decision on which type of fencing is appropriate. General guidelines are provided in Appendix F.
- D. **PAVED AREAS** – Paved areas shall have a minimum of one-half percent (0.5%) slope for concrete and one percent (1%) minimum for asphalt.
- E. **PICNIC SHELTERS** – The size of picnic shelters shall be in relation to size and service area of the park. Minimum sizes are as follows:
- (1) Neighborhood Park – 600 square feet with seating for 15 people.
 - (2) Community Park – 1200 square feet with seating for 50 people.
- F. **COURTS:**
- (1) Courts (tennis, basketball, in-line hockey, etc.) are required within community parks and are generally not located in neighborhood parks. Court design and construction shall adhere to current standard regulations regarding size and layout.
 - (2) City Ownership – All city-owned tennis, basketball and in-line hockey courts shall be constructed of post-tensioned concrete in accordance with the PROS' standard specifications and details.
- G. **SPORTS / PLAY FIELDS:**
- (1) Formal sports fields required within community parks and other large-format parks shall adhere to current standard regulations regarding size and layout.
 - (2) Open, multi-purpose turf areas for informal play within neighborhood parks and other parks shall be 300' x 225' or other dimensions as approved by PROS staff based on site design parameters, constraints and opportunities.
 - (3) City Ownership – All city-owned play fields and their support facilities shall be constructed in accordance with PROS' standard specifications and details.
- H. **SITE FURNISHINGS** – Site furnishings should be integrated into parks and open spaces as appropriate to address the needs of users:
- (1) City Ownership – All city-owned site furnishings shall adhere to PROS' standard equipment list in Appendix F.

- (2) **Bicycle Racks** – Bicycle racks shall be an integral site furnishing for all parks:
 - (a) For neighborhood parks and smaller parks, bicycle racks should generally be located near the focal point or major activity center of the park.
 - (b) For parks larger than a neighborhood park, bicycle racks should be placed at several locations to serve the various user needs for convenience and safety.
- (3) **Potable Drinking Water** – Where the development program for a park calls for potable water for water bottle fillers, drinking fountains, etc., tap fees and the cost of the tap, meter, etc. shall be part of the cost of construction borne by the developer.

I. **RESTROOMS** – Where restrooms are identified as a required programmatic element, a portable toilet enclosure or vault toilet shall be provided. PROS staff will assist in making the final decision on which type of restroom facility shall be used:

- (1) **City Ownership** – Refer to PROS’ standard equipment list in Appendix D for the approved vault toilet used in parks that are city owned and maintained.

J. **PARK SIGNAGE:**

- (1) **City Ownership** – Signs within city-owned parks may include city logos and the words “City of Aurora” for purposes of identification of a site.
- (2) **Non-city Ownership** – Signs at parks that are owned and maintained by a non-city entity, such as a metropolitan district or homeowner’s association, shall not provide signage which includes the city logo or the words “City of Aurora” as a means of identification for a site.
- (3) **Sign Types:**
 - (a) **Park ID Sign** – This type of sign identifies parks and open space sites. Design and location requirements are as follows:
 - (i) Locate one sign near prominent street frontage, corner or primary pedestrian entry.
 - (ii) Sign is double faced and is generally positioned perpendicular to the roadway or at a 45-degree angle from the intersection of two streets.
 - (iii) For all street intersections and vehicular entrances, the sign shall not be located within the sight vision triangle.
 - (iv) The sign setback requirement from the curb flow line of a collector street is twenty feet (20’) and seventeen feet (17’) from the curb flow line of a local street.
 - (b) **Large Notice – Standard Park Rules and Regulations** – This type of sign provides standard rules and regulations for Neighborhood, District and Community Parks throughout the city. Design and location requirements are as follows:
 - (i) Include all funding logos.

- (ii) The sign may be required to have a double or single face depending on the location.
 - (iii) Locate single face signs a minimum three feet (3') from the edge of a walk and parallel to a walk.
 - (iv) Locate double face signs a minimum three feet (3') from the edge of a walk and perpendicular to a walk.
 - (v) Provide signs at major pedestrian entrances or near shelter/picnic areas.
- (c) **Large Notice – Playground and Regulations** – This type of sign includes the park name, age group for which playground is designed for, and safety recommendations. Design and location requirements are as follows:
- (i) Include all funding logos.
 - (ii) For use at all playgrounds.
 - (iii) Locate signs at major access points to a playground or midway between separate playgrounds.
 - (iv) The sign may be required to have a double or single face depending on the location.
 - (v) Locate single face signs a minimum of three feet (3') from the edge of a walk and parallel to a walk.

THIS PAGE INTENTIONALLY LEFT BLANK

SECTION 7

PLANNING & DESIGN PROCESS

7.1 PLANNING & DESIGN FUNDAMENTALS

This section of the manual explains the planning and design process for new parks and open space areas that will be owned and maintained by the city. This process applies to:

- sites that are designed by developers and which will be turned over to PROS to own and maintain after construction; and
- sites designed in-house by PROS.

Commentary: Because of the second scenario noted above, use of the word “developer” in this Section 7 may also have the meaning of PROS staff and any consultant that may be hired by PROS for planning and design projects which are undertaken in-house.

- A. **PROJECT MANAGEMENT** – The Project Manager (PM) is the authorized representative of PROS who will provide overall technical coordination of the process.
- B. **PROS CONTACTS:**
- (1) PM as assigned.
 - (2) Manager of Planning, Design & Construction Division.
- C. **PROJECT COMMUNICATION** – The developer shall keep the PM fully informed of the progress of the work at all times. The developer shall be responsible for preparing and distributing minutes of all meetings.
- D. **PROCESS RESPONSIBILITIES:**
- (1) PROS Responsibilities:
 - (a) The PM will assist the developer in fulfilling the requirements of the planning and design process, if applicable.
 - (b) The PM will provide technical coordination to ensure compliance with all requirements of the planning and design phase.
 - (c) The PM will coordinate all communication, correspondence, transmittal of plans and proposals, and meetings with Denver Water involving projects within the High Line Canal corridor.

(2) Developer Responsibilities:

- (a) The developer will design all hardscape, drainage, infrastructure, utilities, landscaping, irrigation, playgrounds, shelter areas and any other necessary appurtenances for the site.
- (b) It is the responsibility of the developer to coordinate its work with all other consultants and the PM in order to achieve a cohesive design and drawing package.
- (c) The developer shall coordinate its work with all other involved public and private persons or agencies and their technical staff or consultants to obtain the required approval of the design by all necessary city departments and non-city agencies and to secure the necessary approvals/permits.
- (d) The developer shall pay all fees associated with the cost of the review of plans, drawings, specifications and other documents required to secure the necessary approvals/permits for the design and construction of the site.

E. **PROJECT COORDINATION** – The developer and its representatives, such as consultants and contractors, shall meet and comply with any requirements of applicable federal, state, and/or local agencies associated with the project.

(1) Outside Agencies – The developer should anticipate that a final design which affects any agency would have to be accepted by that agency prior to its acceptance by PROS. All submittals to affected agencies shall be coordinated with the PM. The developer shall arrange meetings with others as necessary and as directed by the PM.

(2) City Departments – All design submittals will be reviewed by the following city departments:

- (a) Public Works Department;
- (b) Aurora Water; and
- (c) other departments, if applicable.

F. **CIVIL ENGINEERING CONSTRUCTION PLANS REVIEW PROCESS** – The design, review and approval process for PROS facilities being constructed by developers is a separate and independent process not associated with the civil CDs review process administered by the Public Works Department. The developer shall consult the Public Works Department to determine whether the construction scope for the site warrants the submittal of civil CDs. The developer shall be responsible for submitting all necessary plans to the Public Works Department, securing required approvals and permits, and coordinating the design drawings for the site with all approved civil CDs.

G. **DESIGN STANDARDS** – All drawings, designs and reports shall be in accordance with applicable national, federal, state and local standards including, but not limited to the following:

- (1) American Association of State Highway Transportation Officials (AASHTO).
- (2) Occupational Safety and Health Administration (OSHA).
- (3) Manual on Uniform Traffic Control Devices (MUTCD).
- (4) Americans with Disabilities Act (ADA).
- (5) All applicable codes adopted by the city.
- (6) All designs and their components shall meet the requirements of the following city documents and regulations:
 - (a) If plans are submitted to the Public Works Department for review and approval, they need to also be in conformance with the most recent edition of the *Roadway Design & Construction Specifications* manual.
 - (b) Aurora Water utility standards.
 - (c) Applicable provisions of the City Code.

7.2 MASTER PLANNING PROCESSES

A master plan limits and controls the issuance and validity of all building permits and restricts and limits construction, location, use and operation of all land and structures included within a park/site. The master planning process was established by resolution of the City Council in 1999 and has been updated to account for changed circumstances and needs over time. Properties owned by the city or to be dedicated to the city by developers, except landscaped medians, require adherence to these processes.

A. **MASTER PLANNING PROCESSES** – There are three master planning processes. The process applicable for a specific site will be based on the type of park that is being planned and designed, whether the site is intended to have a staff occupied building, or if the site is already a park and requires a master plan amendment. A flow chart illustrating the first two master planning processes is found on page 98.

- (1) Process for Neighborhood Parks, District Parks and other Un-staffed Properties:
 - (a) Meet with the citizens within the service area of the site to gather public input.
 - (i) Provide notification of upcoming meeting to City Council.
 - (b) Develop the master plan.
 - (c) Take the plan to the Parks and Recreation Advisory Board for a public hearing and for board approval.

- (i) Provide notification to City Council, adjacent property owners, persons who participated in the input process and neighborhood organizations within the service area. Notify other public agencies as appropriate for the proposed uses.
- (d) In case of appeal, the plan could be called up for review and action by City Council.
- (2) Process for Community Parks, Regional Parks, Special Use Parks and any Park with a Staff-occupied Building:
 - (a) Meet with the citizens within the service area of the site, specific user groups, and/or citizens who represent the specific interests represented by improvements proposed for the park to gather public input.
 - (i) Provide notification of the upcoming meeting to City Council.
 - (b) Develop the master plan.
 - (c) Take the plan to the Parks and Recreation Advisory Board for review and for the board to issue an advisory opinion.
 - (d) Take the plan to the Planning & Zoning Commission for a public hearing and for the commission to issue an advisory opinion.
 - (i) Provide notification to City Council, adjacent property owners, persons who participated in the input process and neighborhood organizations within one (1) mile of the site. Notify other public agencies as appropriate for the proposed uses.
 - (e) Take the plan to City Council at study session.
 - (f) Take the plan to City Council at regular session for approval by adoption of resolution.
 - (g) Permitted accessory uses include:
 - (i) Maintenance facilities with screened outdoor storage.
 - (ii) Public plant nurseries.
 - (iii) Underground public utilities.
 - (iv) Vending/concession uses related to park uses approved for site.
 - (v) Stormwater facilities.
 - (vi) Caretaker's residence.
 - (vii) Libraries, museums, or art/cultural centers as ancillary uses to a recreation center.
 - (h) Information required for review:
 - (i) Site Analysis or existing conditions.
 - (ii) Description of proposed program for site use.
 - (iii) Site master plan of sufficient detail to determine:
 - location of proposed uses;
 - adequacy of proposed structure and other improvements; and
 - impacts to adjacent use.

- (iv) Architectural concept drawings and descriptions to include materials and colors.
- (v) Maximum heights and minimum setbacks from property line of proposed structures.
- (vi) Number and location of parking spaces, if applicable.
- (vii) Circulation into and within the site. Traffic study required if significant off-site impacts are expected.
- (viii) Preliminary grading plan. Preliminary drainage study required if significant off-site flows are expected.
- (ix) Location of lighting that has off-site impacts, if applicable.
- (x) Landscape concepts to include landscape types throughout the site (i.e. irrigated turf, native grasses, wetland, planting bed).

(i) Criteria for approval:

- (i) Site design appropriately provides for designated uses.
- (ii) Uses are compatible with or adequately buffered from adjacent uses.
- (iii) Design adequately addresses concerns of adjacent property owners.
- (iv) Access into and within the site is adequate to support proposed transportation modes and uses.
- (v) On-site parking for bicycles and motor vehicles is adequate for proposed uses.
- (vi) Life safety issues are adequately addressed.
- (vii) Architectural theme or concepts of buildings are appropriate for uses.
- (viii) Height is limited to fifty feet (50') for structures and ninety feet (90') for field or court light poles.
- (ix) Detail of plan is adequate to evaluate support of uses specified.

(3) Process for Amendments to a Master Plan:

- (a) For existing parks without a master plan, the as-built condition would be considered the master plan and proposed changes to the site would follow this master plan amendment process.
- (b) The Director of PROS can approve amendments to a master plan unless there is:
 - (i) a significant change in the character of the park use;
 - (ii) a significant increase in the amount of hard surface area or density of use;
 - (iii) an intensification of the external effects on adjacent property;
 - (iv) a significant visual impact, and/or
 - (v) a significant change in the amount of traffic generated by the park use.
- (c) If any of the above conditions in Section 7.2.A(3)(b) exist, the Parks and Recreation Advisory Board could amend the master plan through an affirmative motion after holding a public hearing. The action could be appealed to the City Council. (Notification as outlined above.)

MASTER PLANNING PROCESSES

Process for Neighborhood Parks, District Parks and other Un-staffed Properties

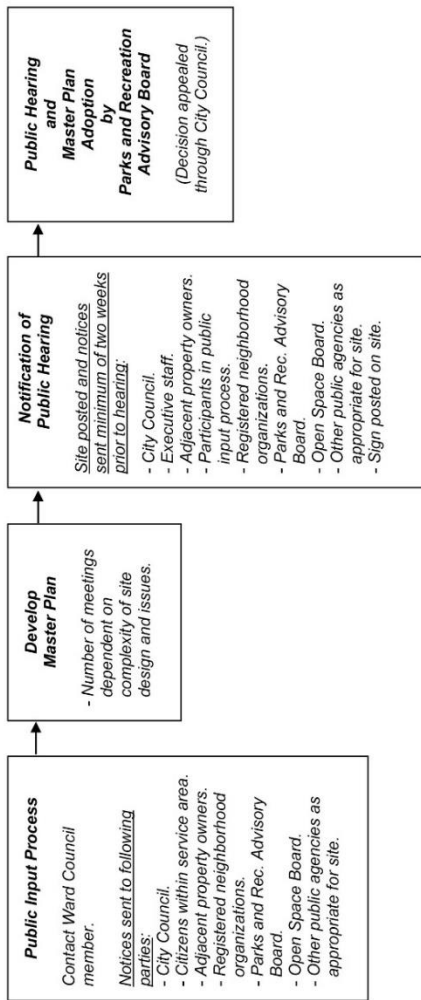

Process for Community Parks, Regional Parks, Special Use Parks or any Park with a Staff-occupied Building

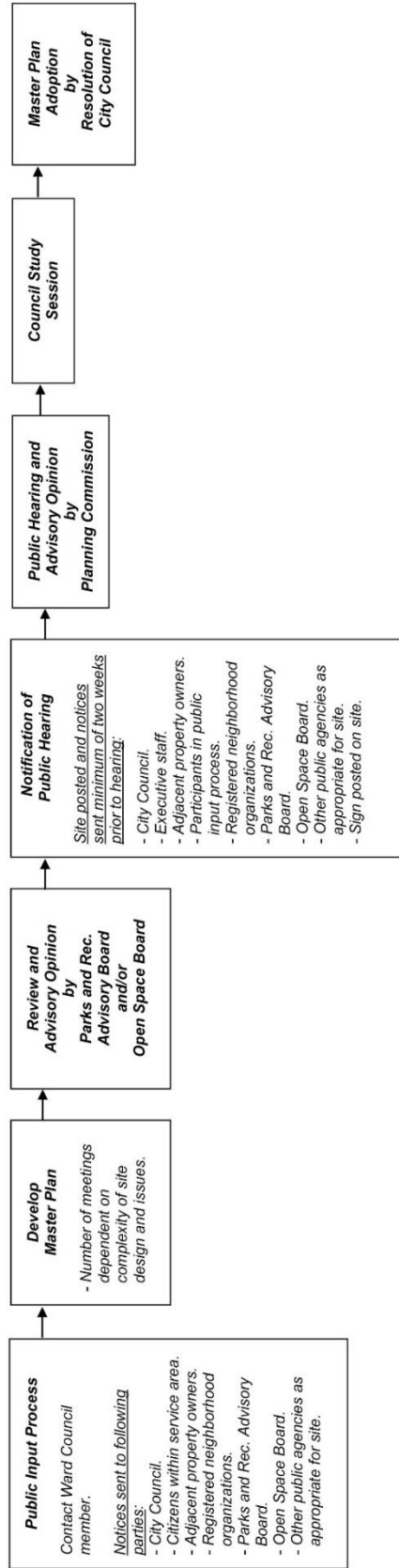

7.3 PROS DESIGN REVIEW PROCESS

The process outlined below is intended for plans that are independently reviewed by PROS. Additional submittal requirements and varied time schedules may apply if plans must be reviewed and approved by other city departments or non-city agencies.

A. REVIEW PROCEDURES AND TIMING:

- (1) Division and Staff Review – Design submittals will be reviewed by the PM and the following divisions of PROS:
 - (a) Planning, Design & Construction Division.
 - (b) Parks & Forestry Division.
 - (c) Open Space & Natural Resources Division, if applicable.
 - (d) Recreation Division, if applicable.
- (2) Pre-Design Meeting:
 - (a) Prior to commencing design of the facility, the developer shall meet with the PM and other applicable representatives of PROS.
 - (b) The developer shall present preliminary schedules for the design and construction of the site.
 - (c) The developer shall present conceptual design for the site. Two (2) weeks prior to meeting, the developer shall send the conceptual design to the PM.
- (3) Design reviews shall occur at the following points in the design process:
 - (a) Conceptual Design (if not approved in the pre-design meeting).
 - (b) Design Development (50% construction drawings) – Plans should indicate location, materials and dimensions of all elements, including play structure manufacturers. Also include a grading plan and cost estimate.
 - (c) 75% Construction Documents – Submittal shall include plans, specifications and cost estimate.
 - (d) Final / 100% Construction Documents – Submittal shall include plans, specifications and cost estimate.
- (4) Allow three (3) weeks for each review. Review drawings and comments shall be presented to the developer in a review meeting at the end of the three (3) week period. If a significant percentage of previous review comments are not addressed, the PROS review will be terminated and the plans will be returned to the developer for revision.

- (5) The developer shall submit the latest versions of the complete set of drawings/plans plus copies of other documents (e.g. drainage reports, geotechnical reports, specifications, etc.) for all reviews.
- B. **PLAN REVIEW FEES** – Once the number of sheets of the full set of plans/drawings to be reviewed and approved by PROS is known, an invoice will be prepared to cover PROS' plan review fee (refer to Section 4.4.E of this manual). The fee structure is a per-sheet cost which is then multiplied by the number of sheets. Payment of the invoice shall be required before final approval of the plans by PROS.
- C. **FINAL APPROVAL OF PLANS:**
- (1) The developer shall make corrections to the plans, specifications, and other submittals until final approval. The developer is solely responsible for correlating all drawings.
 - (2) The developer shall submit final design documents for PROS' signature as two sets. The first set will be digitally signed and professionally sealed "locked." The second set will be a facsimile of the professional's signed and sealed plan set. After PROS affixes its signatures, a digital copy of the set shall be returned as final approval.
 - (3) Signature of the plans by all applicable city departments shall be considered final approval.

7.4 REQUIRED REPORTS AND PLANS FOR SUBMITTAL

The scope of a project, such as whether it only entails master planning or if the design component includes the preparation of construction drawings, will influence the items required for submittal for review and approval.

- A. **REQUIREMENTS FOR A MASTER PLAN** – The following items shall be required for each master plan, as applicable and as determined by the PM on a project-by-project basis:
- (1) Site Survey – The survey provided by the developer shall supply sufficient information to determine existing site conditions, including tree survey information. The developer shall use existing city primary control to establish horizontal and vertical controls for the project. Horizontal alignment shall be tied into all reasonably available aliquot corners (section corners, quarter section corners, etc.). Vertical control shall close on city benchmarks with a maximum error of five one hundredths of a foot (0.05'). Survey information shall extend a minimum of fifty feet (50') beyond the project boundary. Refer to the Public Works' *Roadway Design & Construction Specifications* manual for additional survey control requirements.
 - (2) Geotechnical Report & Soil Testing (fertility and organic content) – The developer shall review information contained in existing reports related to or in the vicinity of the project. The developer shall perform all necessary (if required) supplemental soil sampling and analysis as required for the design.

- (3) Site Analysis – The developer shall provide a site analysis of existing conditions and limitations (to be determined by the PM on a case-by-case basis).
- (4) Site Master Plan – The developer shall provide a conceptual design of the proposed improvements and layout of the site to satisfy identified programmatic needs and priorities based on the available project budget. The plan will be utilized and refined to convey the proposed development of the site for public meetings and the public hearing.

B. REQUIREMENTS FOR CONSTRUCTION DOCUMENTS – The following items shall be required if the project scope includes construction documents. Based on the unique circumstances of each project, some of these items may also be required for master planning, as determined by the PM:

- (1) Drainage Plan – The developer shall coordinate drainage analysis for the site with the engineering consultant and provide all information necessary as required by the Public Works Department within the Drainage Report. The report shall be stamped and signed by an engineer, licensed in the State of Colorado. The Drainage Plan shall be in accordance with Public Works' standards and must go through Public Works' review process.
- (2) Storm Water Management Plan – The developer shall prepare a Storm Water Management Plan (SWMP), consisting of a report and drawings, per the requirements of the *City of Aurora Rules and Regulations Regarding Stormwater Discharges Associated with Construction Activities*. The report and drawings shall include information regarding the methods and location of erosion control BMPs.
- (3) Site Grading Plan – The developer shall prepare a grading plan indicating one-foot (1') contour intervals and all critical spot elevations. The Site Grading Plan must go through the Public Works Department review process. This plan shall be stamped and signed by an engineer licensed in the State of Colorado.
- (4) Layout and Dimensioning Plan – The developer shall produce drawings necessary for the layout and construction of all elements of the site.
- (5) Planting Plan – A plan which shows the location of proposed trees, shrubs, perennials and grasses and specifies the species and quantity of plant material shall be provided. Plant material selection shall be coordinated with the Parks & Forestry Division and/or the Open Space & Natural Resources Division of PROS through the PM.
- (6) Irrigation Plan – The developer shall comply with PROS' irrigation equipment and design standards. If irrigation water taps are required, a utility plan shall be prepared, stamped and signed by an engineer licensed in the State of Colorado, and submitted to the Public Works Department for review and approval.
- (7) Site Details – The developer shall use PROS' standard details, as applicable.

- (8) Utilities Plan – The developer shall design all utilities as required for the completion of the site. All utilities, public or private, existing or proposed, within the limits of the site shall be identified and their respective owners contacted to verify locations by the developer.
- (9) Lighting Plan / Electrical Plan – The lighting design shall include nighttime security levels for the facilities within the site.
- (10) Structural Plans – The developer shall prepare structural engineering plans for all retaining walls over four feet (4') in height or, when terracing, if the horizontal distance between retaining walls is less than one and one-half (1½) times the height of the wall. The developer shall also provide structural plans for all shelters or other structures. All such plans shall be signed and stamped by an engineer, licensed in the State of Colorado. These plans shall be submitted to the Public Works Department for review and approval.
- (11) Specifications – The developer shall use standard city specifications where applicable and as directed.
- (12) Cost Estimates – The developer shall submit cost estimates with each review set, to include appropriate level of detail.
- (13) Construction Schedule – The developer shall propose a suggested construction sequencing plan to be included in the construction documents. The plan will be one method of handling coordination during construction. The plan will satisfy all the concerns of the PM and other owner's representatives. Access to and between the construction site and the primary access road shall be coordinated and assured.
- (14) Documents for Special Sites – In some cases, special documents may be required to minimize negative impacts on the subject park land and adjacent city property:
 - (a) A seeding and revegetation plan may be required if the condition of the soils or vegetative cover and the proposed extent of disturbance within the site warrant.
 - (b) An environmental study may be required if the perceived environmental impact from the proposed site use and development warrants an analysis of options to minimize negative impacts (Refer to Section 5.4.E(5) for more information.)

7.5 DRAFTING AND GRAPHIC STANDARDS

If a specific type of plan must be submitted to other city departments for review and approval, all documents submitted shall adhere to the applicable drafting and graphic standards in place for those departments. If a plan must be submitted to a non-city agency for review and approval, the plan must adhere to the applicable drafting standards set by that reviewing/permitting agency.

A. PROS DRAWING & DOCUMENT STANDARDS:

- (1) All drafting work shall conform to PROS' drafting standards and be prepared using the AutoCAD version currently employed by PROS.
- (2) All drawings shall be provided as electronic submittals during the design review process.
- (3) Sets of drawings shall include a cover sheet with the project title; a vicinity map; sheet index; general notes; contact information for the developer, owner, and all consultants; and a signature block. PROS staff will provide the standard legend, title blocks, and conventions for drafting in AutoCAD. An example of requirements and any work not specifically covered by standards will be provided to the developer for each project.
- (4) All sheets in a plan set shall be numbered consecutively from the cover sheet to the last sheet and the numbers shall be shown in an index column of the title block on each sheet.
- (5) All textual documents, such as technical specifications, shall be prepared based on digital PROS/City specifications. Specifications shall be submitted in Microsoft Word, latest version employed by PROS.
- (6) Once plans and reports are approved, they become the property of the city and remain on file in the office of PROS. All accepted drawings may be used or duplicated as determined necessary by PROS.
- (7) Upon completion and final acceptance, all AutoCAD drawings, electronic files and other documents shall be retained by PROS for record purposes in accordance with city policy.

B. LETTERING:

- (1) Letter height shall not be less than .10" on full-size plans or .05" on half-size plans.
- (2) Preferred minimum letter height is .16" on full-size plans and .08" on half-size plans.
- (3) When lettering is less than .16" on full-size plans or .08" on half-size plans, lettering shall be in uppercase only.
- (4) Standard Font is Arial with 15 degree oblique angle.

C. DOCUMENT SIZE:

- (1) Plans shall be 22" x 34" sheets (or 11" x 17" with approval of the PM).
- (2) Margins shall be a minimum of 1½" left margin and 1" top, bottom and right margins.

- (3) Plans may be formatted as 24" x 36" sheets if the margins allow the drawing to be reduced to ½ scale in 11" x 17" format.
- (4) Reports shall be formatted as 8½" x 11" sheets or 11" x 17" sheets accordion folded to 8½" x 11".

D. SHEET NUMBERING:

- (1) Simple drawing sets should be numbered L-1, L-2, etc.
- (2) Complex drawing sets should be numbered by discipline, for example:
 - (a) S-1, etc. for survey sheets.
 - (b) C-1, etc. for civil sheets.
 - (c) A-1, etc. for architectural sheets.
 - (d) I-1, etc. for irrigation sheets.
 - (e) L-1, etc. for landscape sheets.
 - (f) ST-1, etc. for structural sheets.
- (3) For drawing sets that will be reviewed as civil engineering construction plans (civil CDs), the sheets must also have a sequential sheet number starting at 1 for the cover sheet through XX for the last sheet.

E. LAYER NAMES:

- (1) AutoCAD drawings prepared for PROS projects and which are not submitted to the city for technical review and approval by the Planning & Development Services Department or Public Works Department shall be prepared following PROS' layer name conventions. See Appendix H for standard layer names.
- (2) Plans/drawings that will be submitted as an electronic (.dwg) drawing for compliance with the city's CAD to GIS requirements (see Section 7.5.K below) may be created using other drafting standards which facilitate these requirements.

F. SHADING:

- (1) Hatch patterns can be line patterns or dot patterns only.
- (2) Avoid patterns with dots or lines so close that they will obscure information when scanned or reduced.
- (3) All hatch patterns should be screened back (i.e. color 8 or 9).
- (4) Penciled or colored shading will not be accepted.

G. LINE WIDTHS & COLOR:

- (1) AutoCAD drawings prepared for PROS projects and which are not submitted to the city for technical review and approval by the Planning & Development Services Department or Public Works Department shall be prepared following PROS' line width and color conventions. See Appendix H for the standard pen table (ctb file).
- (2) Proposed and existing topographic features shall be represented on drawings using black lines with a minimum line width of .01”.
- (3) Line widths used in hatch patterns may use finer lines.
- (4) Plans/drawings that will be submitted as an electronic (.dwg) drawing for compliance with the city's CAD to GIS requirements (see Section 7.5.K below) may be created using other drafting standards which facilitate these requirements.

H. LINE TYPES:

- (1) Existing contours shall be shown with a dashed line.
- (2) Proposed contours shall be shown with a solid line.
- (3) No other standards. Select line types that create legible plans.

I. SUBMITTAL OF DRAWINGS – During the review process, plans/drawings shall be submitted electronically, but the following additional submittals shall be required upon formal approval:

- (1) Master Plan – A mounted, color-rendered presentation drawing and an electronic version of the rendered plan for publication purposes.
- (2) Construction Drawings – A set of as-built drawings on mylar, which will be retained by PROS for record purposes.

J. LANDSCAPE ARCHITECT STAMP – Professionals (i.e., Landscape Architects, Engineers, etc.) shall apply their stamp and sign it on the cover sheet of the plan set and on each sheet for which they accept responsibility. Within the specification, they should stamp and sign the table of contents page that includes the sections for which they are responsible. In both cases, beneath the stamp, we recommend that they indicate the sheets/section numbers for which they accept responsibility.

K. CAD TO GIS STANDARDS – The city requires that all final plat, site plans, and civil project submittals (signature sets) be accompanied by an electronic (.dwg) drawing. The drawing shall conform to the formatting requirements of the AutoCAD Data Submission Standard and should include the layers listed in Table 1 which are already required by the respective project design drawings. If specific layers are not included in the project design, those layers are not required in the submittal:

- (1) Drawing templates (which include approved layer names and the city boundary), a standard checker tool, and instructional videos can be found at this URL: <http://tinyurl.com/CADSubmittalStd>
- (2) The electronic drawings will be transferred into the city's GIS system and ultimately, the updated GIS layers will feed additional, more accurate information into Aurora Open Data, which are available for the public to access and download (such as survey control). Explore Aurora Open Data at: <http://data.auroraco.opendata.arcgis.com/>

SECTION 8

CONSTRUCTION PROCESS

8.1 CONSTRUCTION FUNDAMENTALS

This section of the manual explains the construction process for new parks and open space areas that will be owned and maintained by the city. This process applies to:

- sites that are designed by developers and which will be turned over to PROS to own and maintain after construction; and
- sites constructed by PROS.

Commentary: Because of the second scenario noted above, use of the word “developer” in this Section 8 may also have the meaning of PROS staff and any consultant or contractor that may be hired by PROS for construction projects which are undertaken by PROS.

8.2 PRE-CONSTRUCTION PHASE

A. GENERAL REQUIREMENTS:

- (1) Department Responsibilities – The PM will provide technical coordination to ensure compliance with all requirements of the pre-construction phase.
- (2) Developer Responsibilities:
 - (a) The developer shall pay all fees associated with permits and inspections, including water/tap fees, and certificates of occupancy.
 - (b) The developer shall provide PROS with two (2) sets of bid documents and final/100% approved construction documents (plans and project manual) and addendums.
 - (c) The developer shall provide a construction schedule and notify PROS seven (7) days prior to start.

B. PERMITS:

- (1) The developer shall submit approved plans to the Public Works Department and to any other jurisdictional agencies for applicable permits, such as building permits and stormwater permits.
- (2) The developer shall make necessary revisions and obtain approval from the departments/agencies prior to re-submitting plans.

C. BIDDING PROCESS:

- (1) The developer shall send the PM a copy of all addenda when they are sent to contractors.
- (2) The developer shall send the PM a copy of bids/proposals received. The PM will not become involved in contract negotiations between the developer and contractors. The purpose of PROS requesting the bids is to have the cost data for reference during the process of updating the per-acre park construction costs and the park development fees.

D. SELECTION OF CONTRACTOR:

- (1) The developer's contractor shall meet qualifications listed in PROS' standard specifications.

8.3 CONSTRUCTION PHASE

A. GENERAL REQUIREMENTS:

- (1) Department Responsibilities:
 - (a) Attend pre-construction and project progress meetings.
 - (b) Prepare a list of required inspections/submittal reviews.
 - (c) Review submittals.
 - (d) Review change order requests.
 - (e) Review Requests for Information (RFI), Architect's Supplemental Instructions (ASI), etc.
 - (f) Inspect work for compliance with approved plans and PROS standards.
 - (g) Coordinate with other appropriate city departments.
 - (h) Review/approve pay applications.
- (2) Developer Responsibilities:
 - (a) Periodically, visit site to review work.
 - (b) Issue site visit reports.
 - (c) Conduct erosion control inspections and prepare reports, ensure repairs and compliance.
 - (d) Review submittals.

- (e) Send notification of all meetings.
- (f) Attend pre-construction and project progress meetings.
- (g) Provide construction schedule (can be one from contractor).
- (h) Review/approve pay applications.
- (i) Respond to RFIs, ASIs, etc. (after review/approval by the PM).
- (j) Review change order requests.
- (k) Issue change orders (with approval of the PM).
- (l) Provide PROS with two (2) sets of contract documents (plans and project manual) and electronic files.
- (m) Assemble and maintain the project design file, which shall include any inspection and compliance reports required to be retained.
- (n) Provide as-built drawings and specifications.
- (o) Provide engineering and drafting services for design revisions required by changes in construction or field conditions.

B. PROGRESS MEETINGS:

- (1) The developer's contractor shall hold progress meetings on a weekly or bi-weekly basis and issue meeting minutes within five (5) days of the meeting for review. The contractor's point of contact should always be the developer. The PM/PROS will not give directions or answer questions of the contractor directly:
 - (a) Since the city does not have a contractual relationship with the contractor, the PM/PROS should not provide directions that could result in a change order or additional costs incurred by the developer. Lines of communication with the contractor should be through the developer only.

C. SHOP DRAWINGS & SUBMITTALS:

- (1) The contractor shall provide a schedule of submittals and shop drawings.
- (2) The contractor shall send submittals to the consultant and send one copy of each submittal to the PM (or PROS construction inspector).
- (3) The PM will review the submittal and send his/her approval/disapproval to the developer.
- (4) The developer shall forward the approval or disapproval to the contractor.

D. PROJECT DESIGN FILE:

- (1) The developer shall assemble and maintain a project design file as it relates to the scope-of-work contained herein:
 - (a) The file shall contain all reports, calculations, correspondence, meeting minutes or notes, permits and approvals for the project.
- (2) The design file shall be updated and given to the PM after construction is complete:
 - (a) The extent of the design file should be determined for each project and is intended for PROS to have a record of how decisions were made, the public input process, project contacts, etc.

E. CONSTRUCTION SCHEDULE – The developer/contractor shall provide the PM with a schedule prepared using a construction scheduling program to indicate each activity, critical path, start date/end date, etc.

F. CONSTRUCTION INSPECTION (independent of public improvements within public rights-of-way and easements)

- (1) The developer shall perform periodic reviews of work and issue site visit reports to the contractor and the PM.
- (2) The PROS Construction Inspector shall inspect the work at regular intervals and issue reports to the developer and the PM.

G. SUBSTANTIAL COMPLETION:

- (1) The developer shall provide written notification to the PM when it is felt the site is ready for inspection by PROS based on all major functional and aesthetic qualities of the work being completed so that they can be used for their intended purpose.
- (2) The PM will conduct a walk through and review the site with the developer to determine that all major work elements have been completed and the site can be used for the purpose for which it is intended.
 - (a) If both the PM and the developer agree that the work is substantially complete, a certificate of substantial completion will be issued to the developer.
 - (b) If the PM determines the site not to be substantially complete, the developer shall correct deficiencies identified by the PM before a certificate of substantial completion can be issued.
- (3) Upon issuance of a certificate of substantial completion, a punch list of work items yet to be completed prior to final completion will be generated.

H. FINAL COMPLETION:

- (1) The developer shall provide written notification to the PM when it is felt the site is ready for inspection by PROS based on installation being one hundred percent (100%) complete with all deficiencies identified during the substantial completion review corrected.
- (2) The PM will conduct a walk through and review the site with the developer to determine if the project is one hundred percent (100%) complete and in compliance with PROS' design standards and specifications as determined by the PM.
 - (a) If both the PM and the developer agree that the work is determined to be 100% complete, a certificate of final completion will be issued to the developer.
 - (b) If the PM determines the site not to be one hundred percent (100%) complete, the developer shall correct deficiencies identified by the PM before a certificate of final completion can be issued.

I. WARRANTY & MAINTENANCE PERIODS:

- (1) The contractor (or developer) shall warranty the work to be in compliance with the contract documents for a certain number of years from the date of notice of substantial completion. The contractor (or developer) shall also maintain the work during this time period:
 - (a) **Parks and Areas with Irrigation** – The warranty & maintenance period for work done in these areas shall be for a period of two (2) years.
 - (b) **Open Space and Areas without Irrigation** – Work done in open space areas and places that are not irrigated typically involves the use of native seed for restoration/revegetation. Because native seed typically takes a minimum of three (3) years to become firmly established, the warranty & maintenance period for work done in these areas shall be for a period of three (3) years.
 - (c) **Xeric-based Landscaped Medians** – Because medians which are landscaped in accordance with the xeric standard typically are not irrigated, and the plants are subject to harsh growing conditions, the warranty & maintenance period shall be three (3) years.
 - (d) **Extensions** – The warranty & maintenance period shall be extended on a case-by-case basis until acceptable vegetative density is achieved.
- (2) Maintenance of the work shall be in compliance with the requirements of PROS' Parks & Forestry Division for parks and the Open Space & Natural Resources Division for open space areas. At the beginning of the warranty period, the contractor (or developer) shall provide a schedule for PROS' review and approval indicating the services to be performed and the materials to be applied.

- (a) **Xeric-based Landscaped Median Inspections:**
 - (i) Plants within the medians will be inspected by PROS staff three (3) times during the growing season (April 1 through June 1 and September 1 through Nov 1) to identify plants that are dead or dying. The contractor (or developer) shall replace all dead and dying plants within three (3) weeks of inspection.
 - (ii) The contractor (or developer) shall replace dead and dying plants with original species unless otherwise required by PROS. Replacements shall be similar in container size to the plants originally installed.
- (3) PROS will perform final inspection prior to acceptance of maintenance responsibility (i.e. final acceptance). All repairs and replacements (including actions required for compliance prior to closeout of permits) shall be completed by contractor (or developer) prior to PROS acceptance.

J. FINAL ACCEPTANCE:

- (1) When the warranty and maintenance period is near its end, the developer shall provide written notification to the PM that the site is ready for final acceptance inspection by PROS.
- (2) The PM will conduct a walk through and review the site with the developer to determine that all repairs, replacements, and removal of equipment have been completed and the warranty of the functional and aesthetic qualities of the work have been honored.
 - (a) If both the PM and the developer agree that the site is ready for acceptance by PROS, a certificate of final acceptance will be issued to the developer.
 - (b) If the PM determines the site not to be ready for acceptance by PROS, the developer shall correct deficiencies identified by the PM before a certificate of final acceptance can be issued. Until the deficiencies have been corrected and the certificate of final acceptance is issued, the developer shall continue to maintain the site.
- (3) Staggered final acceptance periods may be considered by PROS on a project-by-project basis. Requests for staggered acceptance must be documented and submitted to PROS for review on civil CDs and/or bid documents. Verification of PROS' approval must be provided by the PM in writing at the pre-construction meeting:
 - (a) Native seed establishment is an example of a project-specific circumstance that might warrant staggered acceptance periods. Because establishment for native seed can extend beyond the three (3) year warranty and maintenance period, a project may be segmented such that acceptance of native grass areas is deferred.

K. AS-BUILT DRAWINGS & SPECIFICATIONS:

- (1) Drawings – The developer shall submit one (1) bound copy and one (1) unbound, reproducible copy of the plan set plus electronic files.
- (2) Specifications – The developer shall submit one (1) bound and one (1) unbound, reproducible copy plus electronic files.
- (3) Submittals – The developer shall submit one (1) bound copy of all other submittals.
- (4) Operation and Maintenance Manuals – The developer shall submit two (2) bound copies of operation and maintenance manuals plus electronic files.

THIS PAGE INTENTIONALLY LEFT BLANK

APPENDIX A

LAND DEDICATION CODE EXCERPT

CITY CODE SEC. 146-4.3.18 – SCHOOL, PARK AND OTHER LANDS FOR PUBLIC FACILITIES

B. Park and Open Space Lands and Cash-in-Lieu

1. Requirement

Public land shall be dedicated to provide for parks and open space to serve the future residents of the development. The dedication of such areas shall be as required by an annexation agreement, if one has been approved for the property. If land uses change from those approved at the time of annexation or no annexation agreement exists for the subdivision, park dedication based upon the number of residents of the new land uses as provided in this Section shall be required.

2. Dedication Timing

The dedication of land for parks and open space purposes shall occur, by plat or separate document at the discretion of the City, at the time that the first plat for property adjacent to such land is submitted to the City.

3. Land Dedication Standards

The amount of land dedicated for parks and open space purposes shall comply with the population-based standards in Table 4.3-3.

Table 4.3-3 Standard Acres per 1,000 population	
Facility Type	Requirement
Neighborhood Parks	3 ac per 1,000 residents
Community Parks	1.1 ac per 1,000 residents
Open Space, other Park Uses and Trails	7.8 ac per 1,000 residents

4. Average Household Size

- a. For purposes of applying the population-based standards, population projections shall be calculated based on the following average household sizes:
 - i. 2.65 persons per single-family dwelling unit;
 - ii. 2.50 persons per multifamily dwelling unit;
 - iii. 2.02 persons per dwelling unit in a transit station area; and
 - iv. 1.58 persons per active adult dwelling unit in a residential community:
 - a. In which occupancy is limited by deed or title to residents over 55 years of age, or
 - b. That qualifies as “housing for older persons” as defined and regulated under the federal Fair Housing Act, as amended.

- v. Assisted living, continuing care retirement, skilled nursing and convalescent communities or facilities shall be exempt from the land dedication requirements unless the use includes a mix of dwelling unit types for active adults or persons under age 55, in which case land dedication requirements may be imposed upon the number of units intended to be occupied by persons without the age limitation or residents not in need of personal care or health services.
- b. These numbers may be modified as determined by the City Council based upon census data.

5. Cash-in-Lieu Payments

- a. For subdivisions that are not large enough to generate a minimum of five acres for neighborhood parks and 40 acres for community parks, the City Manager may, at the City Manager's sole discretion, require a cash payment in lieu of land dedication.
 - i. The amount of such payment shall be based upon the market value of property within the subdivision as fully developed, with all attendant infrastructure, in accordance with the land uses approved for the subdivision. This approach to valuing cash-in-lieu shall also be used if cash-in-lieu is accepted for dedication of park lands outside of the subdivision approval process.
 - ii. Cash-in-lieu of land shall only be used to provide park and open space facilities to serve the future residents of the subdivision.
 - iii. Cash-in-lieu payment shall occur at the time that the first plat for the subdivision is submitted to the City.
- b. For infill developments in Subareas A and B and for development within transit station areas that are required to provide cash-in-lieu of land dedication, the amount of such payment shall be based upon a per-acre value derived from a case study analysis of the market value of property acquired by the City for community-based park, recreation, and open space purposes. Such per-acre value shall be determined annually by the Director of Parks, Recreation and Open Space in accordance with the provisions of Section 2-587 of the Aurora City Code.

6. Dedication and Development Criteria Manual

Park and open space land dedication and design criteria, which govern the eligibility of land and areas to receive land dedication credit, shall be as set forth in the Parks, Recreation and Open Space Dedication and Development Criteria Manual.

Commentary:

- *Because of the large size of Aurora and the diversity of development sites that range from greenfield development to urban infill and redevelopment, land values vary greatly from one project to another. The unique characteristics of each site, including location, surrounding development, and existing and proposed land uses, significantly impact fair market value determinations and the subsequent cash-in-lieu of land dedication payments received.*
- *The 2020 case study of the market value of land purchased by the City of Aurora for community-based park, recreation and open space purposes produced a value of \$50,900/acre.*

APPENDIX B

PARK DEVELOPMENT FEE CODE EXCERPT

CITY CODE SEC. 146-5.3.20 – PARK DEVELOPMENT FEES

- A. In addition to other fees required by this UDO, applicants for development and redevelopment containing residential land uses are required to pay park development fees for improvement of parks and recreation facilities. Park development fees shall be payable at time of issuance of building permit.

- B. The methodology and criteria which govern the computation of the fees shall be as set forth in the Parks, Recreation and Open Space Dedication and Development Criteria Manual.

- C. An exemption from park development fees may be granted for developments or portions of developments characterized as assisted living, continuing care retirement, skilled nursing and convalescent communities or facilities.

Commentary:

- *Per-acre park construction costs for 2020 are as follows:*

<u>Park Type</u>	<u>Construction Cost</u>
Neighborhood Park	\$176,794/acre
Community Park	\$177,679/acre

- *Plugging in the above cost data as a variable in the formula used to calculate Park Development Fees results in the following fees for 2020, which are collected at time of building permit issuance per dwelling unit type if projects do not construct each type of park on-site as part of the overall development:*

<u>Fee by Park Type</u>	<u>Fee by Type of Dwelling Unit</u>			
	<u>SF Unit</u>	<u>MF Unit</u>	<u>TSA Unit</u>	<u>AA Unit</u>
Neighborhood Park Fee	\$1,405.51	\$1,325.96	\$1,071.37	\$838.00
Community Park Fee	\$517.93	\$488.62	\$394.80	\$308.81

THIS PAGE INTENTIONALLY LEFT BLANK

APPENDIX C

CAPITAL IMPACT FEE CODE EXCERPT

CITY CODE SEC . 146-5.3.17 – CAPITAL IMPACT FEES

- A. In addition to other fees required by this UDO, applicants for development and redevelopment containing residential land uses are required to pay a capital impact fee in an amount established by the City Council.
- B. The City Council action establishing the residential capital impact fee may include provision for the periodic adjustments of those fees based on specified inflation adjustment factors without further action of City Council.
- C. The City finance director is authorized to establish the amount of the residential capital impact fee annually, based on the base fee amounts and inflation factors most recently approved by City Council.
- D. The amount of the residential capital impact fee and any periodic adjustments for inflation are available in the Planning Department or on the City’s website.
- E. The City Manager is authorized to adopt rules and regulations regarding the administration and application of the fees established by this Section 146-5.3.17.

Commentary:

- *Year 2020 fees for PROS-related purposes are as follows:*

<u>Type of Dwelling Unit</u>	<u>Large Urban, Special Use, & Regional Parks</u>	<u>Recreation Purposes</u>
<i>Single Family Detached Unit</i>	<i>\$629.51</i>	<i>\$371.66</i>
<i>Single Family Attached Unit</i>	<i>\$483.84</i>	<i>\$272.06</i>
<i>Multi-Family Dwelling Unit</i>	<i>\$451.01</i>	<i>\$268.42</i>

- *Fees are collected at time of building permit issuance on a per-unit basis. PROS staff requests approval from City Council to appropriate Capital Impact Fee money, as needed, to fund qualified capital improvement projects as they are budgeted and programmed.*

THIS PAGE INTENTIONALLY LEFT BLANK

APPENDIX D

PARK AND OPEN SPACE STANDARD EQUIPMENT

PLAY EQUIPMENT

- A. **Play equipment** – Below is a list of pre-approved play equipment manufacturers and known local suppliers. Any play equipment companies not on this list are subject to review by the PROS Planning, Design & Construction Division prior to inclusion in specifications and/or drawings.
- (1) GameTime
150 PlayCore Drive SE
Fort Payne, AL 35967
800-235-2440
www.gametime.com
 - (2) Landscape Structures
601 7th Street South
Delano, MN 55328
888-438-6574
www.playlsi.com
 - (3) Little Tikes Commercial Play Equipment
878 E Highway 60
Monett, MO 65708
800-325-8828
www.littletikescommercial.com
 - (4) Miracle Recreation
878 E Highway 60
Monett, MO 65708
888-458-2752
www.miracle-recreation.com
 - (5) Playworld Commercial Playgrounds
1000 Buffalo Road
Lewisburg, PA 17837
800-233-8404
www.playworld.com
 - (6) BCI Burke Playground Equipment
665 N Peters Ave
Fond du Lac, WI 54937
800-266-1250
www.bciburke.com

RESILIENT RUBBER MATTING SUPPLIES

B. **Resilient Rubber Matting Supplies** – The following manufacturer's and products are pre-approved due to warranty and guarantee for poured-in-place playground surfacing. Any resilient matting companies not on this list are subject to review by PROS prior to inclusion in specifications and/or drawings.

- (1) Playbound by Surface America
Rocky Mountain Recreation
c/o Peter and Nancy Christy
PO Box 620411
Littleton, CO 80162
303-783-0452
- (2) GT Impax by Gametime – Triple M Recreation
c/o Doug Johannsen
15982 N 78th St, Suite C
Scottsdale, AZ 85260
800-235-2440
- (3) Tot Turf by Robertson Industries, Inc.
c/o Kelli Bessell
4145 W. Mercury Way
Chandler, AZ 85226
602-340-8873

SITE FURNISHINGS

C. **Site Furnishings** – The site furnishings and manufacturers listed below are considered standard elements within the parks system. Other manufacturers' products may be considered on a case-by-case basis in order to complement a proposed overall park theme or surrounding architecture.

- (1) Benches
Manufacturer: Keystone Ridge Designs, Inc.
Model #: RE26 (Reading Series, Surface Mounted)
Color: Bronze (Other colors may be used for special applications)
- (2) Trash Receptacles
Manufacturer: Keystone Ridge Designs, Inc.
Model #: CRE3D-32 (Reading 30 gallon, litter receptacle with door, elevated legs and flat lid, door to open at ground level to allow 30 gallon steel drum to roll in and out of receptacle on casters. In Open Space areas, dome lids are required to keep wildlife out of trash)
Color: Bronze (Other colors may be used for special applications)
- (3) Pedestal Bottle Fillers
Manufacturer: Most Dependable Fountains (MDF)
Model #: 10100 SMSS
Color: Varies according to surrounding architecture and/or thematic park elements

- (4) Wall Mount Bottle Fillers
Manufacturer: Most Dependable Fountains (MDF)
Model #: 10105 WMSS
Color: Varies according to surrounding architecture and/or thematic park elements

- (5) Picnic Tables
Manufacturer: Iron Mountain Forge
Model #: 264-4NN Painted (No Vinyl), Accessible #264-3NN Painted (No Vinyl) and 266-6N – 6’ Painted (No Vinyl)
Color: Bronze or other according to surrounding architecture and/or thematic park elements

- (6) Collapsible Bollards
Manufacturer: Prosec Inc.
Model #: CB-X w/5-sided hydrant wrench to operate type 2 nut.
Color: Paint to match surrounding architecture and/or thematic park elements

- (7) Removable Bollards
Manufacturer: Custom, drawings available through the Department
Model #: N/A
Color: Paint to match surrounding architecture and/or thematic park elements

- (8) Stationary Bollards
Manufacturer: Complement surrounding architecture and/or thematic park elements
Model #: N/A
Color: Complement surrounding architecture and/or thematic park elements

- (9) Bike Racks
Manufacturer: DuMor Inc.
Model #: 83-Series, S-2 surface Mount
Color: Complement surrounding architecture and/or thematic park elements

- (10) Bike Repair Stations
Manufacturer: Dero
Model #:
Color: Complement surrounding architecture and/or thematic park elements

- (11) Security Lighting (Use Xcel Energy Standard)
Manufacturer: Kim
Model #: Archetype
Color: Bronze

- (12) Street/Parking Lot Lighting
Manufacturer: Kim
Model #: Archetype
Color: Bronze

Or

Manufacturer: Sol
Model #: EverGen M Series, Fixture XSP1HO
Color: NF, Fixture color SV

- (13) Pedestrian Lighting (Not generally used. Subject to approval by PROS.)
Manufacturer: Complement surrounding architecture and/or thematic park elements
Model #: N/A
Color: Complement surrounding architecture and/or thematic park elements
- (14) BBQ Grills
Manufacturer: Patterson-Williams
Model: Double Grill with 7" x 20" shelf
Model #: 1140-10 and 8802-20
- (15) Hot Coal Bin with Accessories
Manufacturer: Pilot Rock (or other)
- Hot Coal Bin with Lid
Model: HCB / C – black powder coated
 - Hot Coal Bin with Lid
Model: HCB / C – black powder coated
 - Steel Collection Can
Model: CNG-2310C-galvanized steel, 31-gallon capacity
 - Hex Sleeve Anchors
Model: BR-4HSA

Or

Manufacturer: BBQGUYS.com (or other)

- Steven Raichlen Cast Aluminum Charcoal, Pellet & Ash Scoop
Model: SR8013
ID #: 2861892

Note:

* Contractor is required to connect the scoop to the hot coal bin with a vandal proof wire on a length long enough to reach and clean out the grill.

PREFABRICATED VAULT TOILETS

D. **Prefabricated vault toilets** – Below is a list of pre-approved vault toilet manufacturers and known suppliers. Any vault toilet manufacturers not on this list are subject to review by the PROS Planning, Design and Construction Division prior to inclusion in specifications and/or drawings.

- (1) Gunnison No. G-1468 (without front entry wind screen) by LB Foster, CXT PRODUCTS
CXT Incorporated
3808 N. Sullivan Road, Bldg 7
Spokane, WA 99216
509-921-8718

PARK SIGNAGE

- E. **Park Signage** – PROS has developed a standard signage package for parks, open spaces and trails which are owned and maintained by the city. Siting, setbacks and budget for park identification signs, and rules and regulation signs must be accounted for within all new park plans. Drawings and pricing information available from PROS staff.

THIS PAGE INTENTIONALLY LEFT BLANK

APPENDIX E

STANDARD IRRIGATION EQUIPMENT

IRRIGATION EQUIPMENT

Application	Manufacturer	Product	Additional Comments
IRRIGATION HEADS			
Spray heads -Spray Nozzles	Rainbird	1806-SAM-PRS 5' -15'	U-Series Nozzles
Spray heads -Rotary Nozzles	Rainbird	1806-SAM-PRS 8' - 24'	RN or R-VAN Rotary Nozzles
Small / Medium area rotor	Hunter	I-20-06-PRB-SS 17' - 46'	6" Popup, pressure regulating
Large rotors Native areas	Hunter	I-25-06-SS 40' - 71'	6" Popup
Med./large rotor	Hunter	I-40-06-SS 44' - 69'	6" Popup
Long range rotor	Hunter	I-80-04-SS 63' - 97'	<u>special applications only</u>
**Please include stainless steel riser option.			
DRIP / SHRUB			
Drip/subsurface	Rainbird	XFS,.6GPH, 12"	
Shrub spray/bubbler	Hunter	MSBN Multi Stream Bubbler	
Pressure Regulator/Filter	Rainbird	PRB-100 w/ QKCHK-120M screen	Must meet zone flow requirements.
VALVES			
1"-2"	Weathermatic	Black Max - DW 11024FCR	with PRK-24 pressure regulator
QuickCoupler	Rainbird	44RC	
Ball Valve	Nibco	T-580A	Brass, FIP Threaded
Isolation Valve	Leemco LMV	Spigot x Bell Mainline Gate Valve	Installed at Tees on mainline.
Stop and waste valve	Ford	Brass curb stop 3/4" - 2"	w/ stop and waste option
Drain Valve	Ford	1" brass Curb Stop	B81-444 MIPT x FIPT
MASTER VALVES / FLOW METERS			
1/2" – 8" hydrometer	Bermad	900 series	<u>See plan legend.</u> output = 1 pulse/10 gal. for 2" and smaller output = 1 pulse/100 gal. for 2-1/2" and larger
Ultrasonic flow meter	Flomec	QS200	Use for small drip systems with low flows.
Brass Master Valve	Weathermatic	8200CR	Use for small drip systems with low flows.
CONTROLLERS			
Central system	Motorola	***Irinet	No longer being installed.
DC (battery powered)	Motorola	***Irinet	No longer being installed.
Non central system	Hydropoint	WeatherTRAK OptiFlow XR	SS Pedestal; 2-wire system preferred
DC (battery powered)	Hunter	Wireless Valve System	
Enclosures	Strong Box	SB-24SS	***Irinets within access to City Network may require IP connection.
BACKFLOW ENCLOSURE			
Aluminum Enclosure	Strong Box	SBBC- ?? ALHP	30" - 60" - dependent on size needed
Quickpad	Strong Box	QP - ?? BF	For use with SBBC.
MISCELLANEOUS			
Main line fittings	Leemco	ductile iron parts	
MJ fittings	150PSI min rating	ductile iron parts	For PROS detail I-2.2
PVC Pipe	-	-	class 200 min.
PVC Cement	IPS Weld-On	711-heavy bodied grey	w/ P-70 purple primer
1" Swing Joint	Rainbird	TSJ-12	
3/4" Swing Joint	Rainbird	TSJ-12075	
Backflow preventer	Febco	825YA 3/4" - 2"	880 on 3" and larger
Valve Boxes	Pentek		"t-top" lid w/ snap lock - Purple for Non Potable Green for domestic supply
Rain sensor	Hunter	Rain Click	
Wire Splice Kit	Paige Wire	DBY / DBR	DBY 18-12, DBR 16-10 AWG
Control Wire - Conventional	Paige Wire **	varies	Wire to be properly sized.
Two-wire decoder cable	Paige Wire **	14AWG 2-wire 12AWG	**FOLLOW CONTROLLER MANUFACTURER RECOMMENDATIONS**

CONTACTS

STANDARD IRRIGATION EQUIPMENT CONTACTS

Netafim	Kelly Keicher	303-805-7830	kkeicher@netafimusa.com
Rainbird	Mark Austin	720-810-7066	maustin@rainbird.com
Hunter	Eric Schneider	303-570-4429	eschneider@hunterindustries.com
Motorola	Saul Hirschmann	949-552-6552	cmotorola@aol.com
CPS	Brandon Gully	303-961-6959	gullyb@cpsdistributors.com
Denver Brass Company	Scott Wyborny	720-402-9359	wborny@dbcirrigation.com
Febco (Dillon Company)	Todd Welch	303-399-5566	tod@thedillon.com
Leemco	Jason Mower	720-233-9698	jmower@aquacita.com
Guard Shack	Jason Mower	720-233-9698	jmower@aquacita.com
Pentek Valve Boxes	Todd Welch	303-399-5566	tod@thedillon.com

APPENDIX F

FENCING GUIDELINES

FENCE TYPES

Several types of fencing are used within and adjacent to properties owned and/or managed by PROS. The extent and type of interaction intended between the two adjacent properties determines the type of fence required in each application. PROS staff will assist in making the final decision on which type of fencing is appropriate. General guidelines are provided below.

Fence type	Description	Application
3 rail open space fence with pet mesh (Variation: 54 inches in height to protect areas designated for preservation and limited access)	48-inches in height -- treated wood posts and rails with wire mesh on private property side.	Standard fence to be used between private property and parks and open space properties. Pet mesh is not optional and is required to keep pets within private properties as well as to keep wild animals out to some extent.
Post and mesh	5 feet in height with treated wood posts, rails at the top and bottom, wire mesh on private property side.	Used to protect areas designated for preservation and limited access. Example: Plains Conservation Center
Steel/Iron fence with masonry columns	6 feet masonry columns 100 feet OC with 58 inch steel/iron rails/panels.	Used to protect areas designated for preservation and/or limited access. Example: Aurora Reservoir & Saddle Rock Golf Course
Post & cable	Round treated wood posts, steel cable	Used to prevent vehicular access into natural areas and trail corridors
Vinyl coated chain link	Black vinyl coated steel posts & chain link fabric- height varies	Primarily for use within developed areas for tennis courts, ball fields, etc. Generally not used within natural areas.
T-post & wire fence		Delineates boundary of construction access and site disturbance. Occasionally used for temporary access control.
Construction fence	Orange plastic fabric with steel t-posts	Delineates boundary of construction access and site disturbance, including affording tree protection. Occasionally used for temporary access control.
Erosion control fence		Controls sediment erosion. Not to be used to control access.

Fence type	Description	Application
Wildlife fence	4 feet in height with treated wood posts and 26-inch wide woven wire fabric mounted 22 inches from the ground.	Used adjacent to parks and open space properties to restrict movement of certain wildlife and yet allow other species to pass underneath the fence.
Prairie dog fence	30-inches in height -- treated wood posts, possibly including braces, with fabric buried 1 foot beneath the ground and a 5-foot wide chicken wire laid horizontally on the ground surface.	Used to manage the migration of prairie dogs from existing colonies on to parks and open space properties.

See standard details in Appendix J for additional information related to materials and construction.

APPENDIX G

TREE PROTECTION POLICIES

(Excerpts from the City Code and ordinances.)

POLICY ON PROTECTION OF EXISTING TREES

I. Policy:

This document represents the policy of the City of Aurora that existing trees within the City, which are alive and in good health, shall remain in their present location and shall be safeguarded from damage that may result from the development process. Therefore, existing healthy trees, with a caliper greater than or equal to 4 inches, as measured four and one-half (4½) feet above the ground, shall be preserved or protected during the development process.

This policy shall be incorporated into the Planning Department Landscape Review Procedures for site plan approval. In addition, this policy shall also be applied to properties or sites not required to provide a site plan.

II. Scope:

This policy shall apply to all residential and non-residential development projects within the City of Aurora, including City projects on City-owned or managed properties. Exempted from this policy are single-family detached residential properties where additions or modifications to existing buildings, or improvements to the lot, are proposed.

III. Definitions:

For the purposes of implementing this policy, the following terms are hereby defined:

- Development process - the intent to construct upon, improve, or modify any property within the City of Aurora, whether governed by a Site Plan or not.
- Intent - having the mind, attention, or will to develop, modify, construct or improve real property within the City of Aurora.
- Mitigation – the replacement of trees removed from a site due to the development process. Replacement may include relocation of existing trees, the planting of caliper inches lost or cash payments to the Tree Planting Fund.
- Preservation – the act of keeping existing trees safe from injury, harm or destruction during the development process.

- Relocation - the practice of moving an existing tree to another site or other location within the same site.
- Tree protection zone - generally, an area encompassing one linear foot in radius around the tree per inch of trunk diameter. For example: a tree 12 inches in diameter (measured at 4.5 feet from the ground) should have a disturbance free zone with a 12-foot radius around the tree, as measured from the tree trunk.

IV. Properties Affected:

A. Properties Governed by a Site Plan:

Applicability: Generally includes residential and non-residential properties within the City of Aurora, except as noted in section IV, subsection D: “Properties Not included in this Policy”.

Requirements: Properties in this category must comply with the following items:

- Preservation: Site designers shall make all feasible attempts to accommodate existing trees within their design.
- Relocation: If tree relocation within the site is attempted, it shall be performed by a professional forester or nurseryman. All available measures shall be taken to ensure the life and good health of the tree(s).
- Mitigation: A tree mitigation plan shall be specified. Mitigation plans shall consist of an equal replacement of tree caliper inches lost on site. These plans shall indicate the trees that are proposed to comply with mitigation requirements, including the location of replacement trees and the location of trees that are proposed for relocation. No tree for mitigation shall be less than two inches in caliper and shall be of no less quality species than the tree removed, as determined by the Tree Appraisal Guidelines published by the International Society of Arboriculture (ISA), as amended.

For example: two ten-inch caliper trees are removed because of site constraints; the caliper inches lost equals 20 inches. These inches can be replaced by planting five four-inch caliper trees or four five-inch caliper trees. If the trees removed are blue spruce, they could not be replaced with an upright juniper or other tree species that is considered of lesser quality by the ISA Guidelines.

Should on-site tree replacement and/or relocation not be possible, tree replacement and/or relocation shall take place through any or all of the following methods:

- Replacement of equal caliper lost on another site.
- Replacement of equal caliper lost on public lands. Relocation of trees to public lands.
- Payment of value of caliper lost to the Tree Planting Fund.

Mitigation shall be in addition to standard landscape requirements established by the Planning Department. Trees planted to comply with standard landscape requirements may not be counted as satisfying tree mitigation requirements. In the case of tree removals, the location, species, and caliper of trees to be removed and their replacements shall be included on the landscape/site plan. In the case of tree relocations on site, the placement of the relocated trees shall be included on the landscape/site plan.

B. Properties Not Governed by a Site Plan

Applicability: Generally includes properties that were developed before existing Site Plan requirements were in place or were not required to provide a Site Plan.

Examples of this type of property include:

- Non-residential properties that were developed before existing Site Plan requirements.
- Single-family detached residential infill or single-family detached lot division projects.
- Multi-family and single-family attached residential properties.

Requirements: Properties in this category shall comply with the same rules and guidelines set forth for properties governed by a site plan.

C. Projects on City Property

Healthy trees within City-owned properties, City-owned or designated street rights-of-way, City-managed properties and easements or City-managed projects, shall not be removed or damaged during construction or development projects, except as a last alternative or to preserve public health and safety. Future planning or alteration of existing City properties, projects or rights-of-way shall make provisions for the preservation of existing trees. If preserving existing trees is not feasible, City Departments shall follow the same rules and guidelines set forth in section IV, subsection A of this policy.

D. Properties Not Included in this Policy

Single family or two family developed residential properties.

V. Procedures:

A. Protection of Existing Trees During the Construction Process

Site construction shall take into account the life and good health of trees preserved on the site. The following guidelines shall be followed for tree protection. If these guidelines are not followed, the full value of the tree will be used in calculations to determine mitigation requirements.

- Protective fencing shall be set up to visibly show the tree protection zone.
- All equipment, including foot traffic shall remain outside of the tree protection zone.

- If roots greater than 1-inch in diameter require removal, a clean cut shall be accomplished using a sharp hand tool. A maximum of two 3-inch diameter roots per tree are permitted for removal. The removal of additional roots 3-inches or greater in diameter requires approval of the City Forester or designee.
- Limb removal shall be accomplished before construction begins. A professional company that is licensed by the City of Aurora Forestry Division shall complete all pruning.
- Designate concrete washout areas. These areas shall not flow into or across the tree protection zone.
- No stockpiling of soil is permitted within the tree protection zone.
- No vehicle parking is permitted within the tree protection zone.
- The soil shall not be compacted within the tree protection zone.
- Existing trees damaged through the construction process shall be immediately repaired and if damaged beyond repair, replaced per the mitigation specifications outlined in section IV, subsection A, item 3. The restoration plan for these trees shall follow that approved through the site plan submittal.

B. Interruption and Maintenance of Drainageways

1. Drainage plans for individual sites shall not alter the supply of water to existing stands of trees if the longevity of those trees is dependent upon the flows. If the drainage of the site requires altering the existing supply of water, some alternative form through the use of irrigation shall be available from the time the existing watering source is eliminated.
2. This policy shall not preclude standard maintenance of drainageways necessary to ensure the free flow of storm water. It will, however, protect those trees that do not interfere with the flow of storm drainage. Drainageways shall be maintained at the density of trees for which they were designed and future drainageways shall be designed, as far as economically feasible, to consider preservation of mature stands of trees. If preservation is not possible, mitigation and/or replacement shall be accomplished, as outlined in section IV, subsection A, item 3.

C. Timing for Tree Mitigation Activities

Tree preservation and/or mitigation may be accomplished at any time during the development process. The timing of these activities is especially critical when moving trees from one location to another. The City Forester, or designee, shall determine the conditions that will ensure the optimal success for tree relocation, preservation or mitigation.

When feasible, the decision to relocate trees will be made after all Planning process requirements are completed. In cases where conditions necessitate the relocation of trees before all Planning processes are complete, the Developer and adjoining property owners shall be notified that these activities do not guarantee project approval and that these activities are undertaken at the Developer's risk.

Tree Mitigation Fee Collection

Collection of Tree Mitigation Fees, as determined by the City Forester, will occur prior to finalization of the subdivision plat. The Director of Parks, Recreation and Open Space, may withhold approval of the final subdivision plat until collection of all fees.

BLACK FOREST ORDINANCE

Section 146-4.7.7. Tree Preservation

1. Intent

The standards in this Section 146-4.7.7.B are intended to protect the Black Forest area's unique ecosystem of non-mountainous extensions of Ponderosa Pine onto the high plains; protect the wildlife habitat created by its high quality Gambel Oak and Ponderosa Pines; and to achieve additional benefits of mature tree preservation, including shade and evaporative cooling, absorption of carbon dioxide and ozone, reducing soil erosion, increasing real properties, and enhancing the visual appeal of the area. The standards for the Black Forest Area are enacted to:

- a. Maintain a sustainable tree cover within the Black Forest by locating new development in a manner that preserves existing trees to the maximum extent practicable;
- b. Protect existing trees during development from the impacts of nearby construction; and
- c. Provide standards governing the removal, relocation, and monitoring of trees that cannot be preserved in their original location.

2. Applicability and Exemptions

This Subsection applies to that portion of the Black Forest located in Aurora as defined in the Definitions. Exemptions include:

- a. Trees that are diseased or constitute a threat to the public health and safety; and
- b. Routine forestry management and fire safety practices in accordance with the Colorado State Forest's Forest Management Plan guidelines and developed by a professional forester.

3. Development Review.

Any development activities and/or submittal of development applications to the city within the Black Forest shall include a tree protection plan in order to preserve existing Ponderosa Pine trees and associated Gambel Oak shrub vegetation to the greatest extent feasible. Development activities shall not result in the removal of any Black Forest trees and shrubs, except in accordance with this section.

- a. *Plan requirements.* Any development activities or proposed development applications that involve disturbing the natural surface of the land or making any material change to any structure shall require the submittal of a tree protection plan that conforms with this section and requirements set by the City Forester's office. In order for the plan to be approved, Black Forest trees shall be protected according to the procedures described herein. Following tree protection plan approval, any subsequent development activity requiring approvals or the issuance of any permits shall conform to the plan. A minimum, all such plans shall include:
 - i. An inventory of trees and existing shrub vegetation, including a description of which trees are candidates for preservation, removal, and replanting. The inventory shall include Ponderosa Pine greater than four inches in diameter and all Gambel Oak plants greater than three inches in diameter.

- ii. A construction limit line, which shall include all building, parking, underground utilities, vehicular use areas, and all areas of required cut and fill.
 - iii. Details and locations of permanent and/or temporary construction protection devices and measures to assure tree protection and normal growth after construction.
 - iv. A description of the size and location of all new trees to be planted as part of the landscape design of the proposed project.
 - v. A conservation escrow account to collect funds from the owner or representatives in order to insure compliance with the tree preservation measures described herein. The amount to be collected will be based upon *The Guide to Plant Appraisal*, published by the International Society of Arboriculture. This figure will be assessed as an average diameter calculated from the total inventoried number of only those trees remaining in place and potentially impacted by construction activities. It does not include those trees outside of the construction limit line and, therefore, not impacted by construction activities as well as those which are to be removed or replanted according to plan specifications. The amount will be returned to the owner upon completion of construction activities and implementation of tree protection plan requirements. If these measures are not complied with, the city shall use these funds to mitigate tree loss.
- b. *Plan Approval.* Review and approval of the tree protection plan according to requirements set by the planning department and forestry division shall be completed by the city forester's office before the commencement of any development or planned development activity. Plans will be approved, approved with condition, or denied based upon conformity with the requirements of this approved tree protection plan.
 - c. *Plan Amendment.* The city forester may amend any approved tree protection plan after receipt of an application for amendment from a property owner. The amendment shall be approved if the city forester determines that the proposed amendment complies with the requirements of this section.
 - d. *Plan recordation.* After approval of a tree protection plan, it shall be recorded in the office of the county clerk and recorder and shall be binding on the property owner and the owner's heirs, successors, and assigns.

4. Tree Removal and Mitigation.

- a. *Tree removal.* Black Forest trees and associated vegetation shall not be removed from their existing location due to any development or construction activity unless avoidance through modifications of proposed development plans and design is not feasible. Tree removal is unlawful unless it is pursuant to an approved tree protection plan.
- b. *Mitigation.* Trees to be relocated shall be replanted at a suitable location on the site. Candidate trees for replanting will be greater than four inches for Ponderosa Pine and three inches for Gambel Oak, but less than ten inches in diameter measured at a point one foot above natural grade. When such replanting is not feasible, removed trees shall be replaced. Such replacement shall occur at a ratio of one-to-one with an approved single tree of similar size or combination of trees (not to exceed six in number) measured at a point one foot above the natural grade with a cumulative total diameter equal to the diameter of the tree to be mitigated. Mitigated trees shall be

measured per the "Guide to Plant Appraisal." Appropriate measures shall be undertaken to protect trees from construction activities. If any of the trees required to be retained or replanted as part of the tree protection plan should die within a period of three years after completion of construction, the property owner shall replace the trees within six months of the issuance to the owner of a notice to replace.

- c. *Tree Protection.* Appropriate measures shall be undertaken to protect trees from construction activities. If any of the trees required to be retained or replanted as part of the tree protection plan should die within a period of three years after completion of construction, the property owner shall replace trees within 6 months of the issuance to the owner of a notice to replace.

5. Monitoring.

In addition to protection during new construction, provisions for monitoring are required to ensure that trees will be retained after construction is completed. Monitoring programs shall include:

- a. On-site supervision by the property owner or representative to ensure tree protection actions;
- b. Pre-construction conferences between the property owner or representative and the city forester or designee;
- c. Monthly meetings between construction management and the city forester to review progress of the monitoring program; and,
- d. Final site inspection to verify that protection provisions have been followed.

6. Notice to Prospective Purchasers.

Vendors of real property located within the Black Forest shall provide the following notice to prospective purchasers and cause such notice to be recorded with the Clerk and Recorder of Arapahoe County:

**NOTICE:*

The property described as (legal description and address) is located within an area governed by the Black Forest tree preservation ordinance, 146-1430, et seq. And a tree protection plan and is subject to the requirements therein, as applicable.

THIS PAGE INTENTIONALLY LEFT BLANK

APPENDIX H

PROS DRAFTING STANDARDS

Layer Names:

(add other layers as needed based on this format)

Administrative

0-A-defpoints
0-A-matchline
0-A-notes to self
0-A-text

Civil

0-C-property-line
0-C-road-center-line
0-C-road-flow-line
0-C-concrete-pan
0-C-easement
0-C-survey (+/- text)
0-C-dims

Cover Sheet

00-CS-blocks
00-CS-defpoints
00-CS-text

Details

0-D-concrete
0-D-dims
0-D-grade
0-D-hatch
0-D-labels
0-D-mulch
0-D-notes
0-D-shrub-dec
0-D-text
0-D-trail
0-D-tree-dec
0-D-wall
0-D-wire
0-D-wood

Grading

0-G-BMPs
0-G-dims
0-G-econtour
0-G-egrade
0-G-espots
0-G-pcontour
0-G-pspots
0-G-pgrade
0-G-swale
0-G-text

Hardscape

0-H-conc
0-H-dims
0-H-grade
0-H-splashblock
0-H-subgrade
0-H-text
0-H-walk
0-H-walk-score
0-H-wall

Irrigation

0-I-boring
0-I-controller
0-I-dims
0-I-dripperline
0-I-elec
0-I-heads-popup
0-I-heads-rotor
0-I-lateral
0-I-mainline
0-I-sleeves
0-I-text
0-I-valves

Landscape

0-L-dims
0-L-edger
0-L-existing-vegetation
0-L-omgrass
0-L-perennial
0-L-shrub-deciduous
0-L-shrub-evergreen
0-L-sod-hatch
0-L-sod-hatch-boundary
0-L-stone
0-L-text
0-L-tree-deciduous
0-L-tree-evergreen
0-L-tree-ornamental

Playground

0-P-curb
0-P-drainage
0-P-equip
0-P-fallzone
0-P-surface
0-P-text

Site Features

0-S-bollard
0-S-building
0-S-dims
0-S-fence
0-S-furniture
0-S-light
0-S-parking stripe
0-S-retaining wall
0-S-structure
0-S-text

Utilities

0-U-cable
0-U-electric
0-U-fiber
0-U-gas
0-U-phone
0-U-sanitary
0-U-storm
0-U-text
0-U-water

Title Block

00-TB-border
00-TB-defpoints
00-TB-logo
00-TB-text

For Plans prepared by consultants, use the above layer names from the first page and replace the "0-" with the following prefixes:

Surveyor – add SU-
Architect – add AR-
Civil Engineer – add CE-
Structural Engineer – add SE-
Mechanical/Electrical/Plumbing Engineer – add MEP-
Irrigation Designer – add IR-

Standard Pen Table (POSD Standard Pen Table 22x34.ctb)

Red	.08 mm
Yellow	.15 mm
Green	.25 mm
Cyan	.35 mm
Blue	.45 mm
Magenta	.55 mm
White	.75 mm
No. 8	.15 mm @ 50%
No. 9	.15 mm @ 20%
No. 16	.25 mm (for defpoints/non-print layers)

11" x 17" Pen Table (POSD Standard Pen Table half size.ctb)

Red	.04 mm
Yellow	.075 mm
Green	.125 mm
Cyan	.175 mm
Blue	.225 mm
Magenta	.275 mm
White	.375 mm
No. 8	.075 mm @ 50%
No. 9	.075 mm @ 20%
No. 16	.125 mm (for defpoints/non-print layers)

APPENDIX I

STANDARD TECHNICAL SPECIFICATIONS

Standard Technical Specifications

Submittals 01300	01300 thru 01300-4
Tree Protection 01530	01530 thru 01530-2
Traffic Control 01570	01570 thru 01570-3
Project Closeout 01700	01700 thru 01700-4
Warranty 01800	01800 thru 01800-3
Maintenance 01900	01900 thru 01900-7
Site Preparation 02100	02100 thru 02100-3
Earthwork 02200	02200 thru 02200-6
Seeding and Sodding 02480	02480 thru 02480-10
Crusher Fines Paving 02510	02510 thru 02510-5
Poured-in-Place Resilient Matting 02540	02540 thru 02540-5
Hydro Mulching 02550	02550 thru 02550-4
Site Improvements 02800	02800 thru 02800-10
Irrigation System 02810	02810 thru 02810-16
Three Rail Open Space Fence 02832	02832 thru 02832-2
Plains Conservation Center Fence 02833	02833 thru 02833-3
Post and Cable Fencing 02835	02835 thru 02835-5
Landscape Installation 02900	02900 thru 02900-14
Concrete 03000	03000 thru 03000-14
Painting 09900	09900 thru 09900-4

THIS PAGE INTENTIONALLY LEFT BLANK

SUBMITTALS
01300

PART 1 GENERAL	1
1.1 General	1
1.2 Progress Schedule	1
1.3 Traffic Control Plan	1
1.4 Submittals List, Schedule and Procedures.....	1
1.5 Shop Drawings	2
1.6 Product Data	3
1.7 Job Site Documents.....	3
1.8 Field Measurements	3
1.9 Samples.....	3
1.10 Certificates of Compliance.....	4
1.11 As Built Drawing	4
PART 2 PRODUCTS	4
NOT USED.....	4
PART 3 EXECUTION	4
NOT USED.....	4

SUBMITTALS
01300

PART 1 GENERAL

1.1 General

Submittals shall be made early enough to account for processing described below and a minimum of fourteen (14) days for review by the City of Aurora Project Manager and consultants.

1.2 Progress Schedule

- A. The schedule shall be in the form of a chart, indicating the start and completion of each of the various elements as listed on Bid Form/Contract Proposal. The schedule shall indicate the major dependencies among elements on the schedule. The completion time shall be as specified in the Agreement. The schedule shall be revised when the completion time is revised by Change Order.
- B. At the Pre-Construction meeting, submit four copies of a preliminary construction schedule. Within ten (10) days after receipt of review comments on preliminary schedule, submit a revised construction schedule. With each monthly application for payment, submit a copy of the updated construction schedule indicating actual work progress in comparison to scheduled progress.
- C. Prepare and submit an estimate of partial payments as reflected by estimated work progress with submittal of construction schedule.
- D. With each monthly application for payment, submit an itemized report of the delivery status of major and critical items of purchased equipment and material, including Shop Drawings and the status of shop and field fabricated work.
- E. If the completion of any part of the work or the delivery of materials is behind the construction schedule, submit a plan for bringing the work up to schedule. The City of Aurora Project Manager shall have the right to withhold progress payments for the work if the contractor fails to update and submit the progress schedule and reports as specified.
- F. Nothing on these requirements shall be deemed to be usurpation of the Contractor's authority and responsibility to plan and schedule the work as he/she sees fit, subject to all other requirements of the Contract Documents.

1.3 Traffic Control Plan

- A. Contractor shall submit a Construction Phasing/Traffic Control Plan to the City of Aurora, Traffic Engineering Division, and the City of Aurora Project Manager, and receive approval by the City of Aurora, Traffic Division. The Contractor shall adhere to the plan and stipulations approved by the Traffic Division and Project Manager.

1.4 Submittals List, Schedule and Procedures

- A. **Submittal:** At or before the Pre-Construction Conference, and before any items are submitted for review, submit to the City of Aurora Project Manager a submittal list and schedule, one of which shall be forwarded to Landscape Architect.

- B. **Schedule:** Compile a complete schedule of all submittals anticipated to be made during process of the work. Include a list of each type of item for which Contractor's drawings, Shop Drawings, Product Data, Certificates of compliance, Samples, Warranties or other types of submittals are required. Indicate on the schedule the dates when approval is required to achieve the approved Construction Schedule. Upon acceptance by the City of Aurora Project Manager, the Contractor will be required to adhere to the schedule except when specifically permitted otherwise.
- C. **Code Designation:** On the schedule, designate each item with a number code utilizing the Specification Section five-digit numbers. Each submittal shall be marked with the same code designation.
- D. **Coordination:** Coordinate the Schedule with Subcontractors and materials suppliers.
- E. **Revisions:** Revise and update the schedule on a monthly basis as necessary to reflect conditions and sequences. Promptly submit revised schedules to the City of Aurora Project Manager for review.
- F. **Transmittals:** Include a transmittal letter with each submittal, identify item by above code designation and reference to Specification Section. Use a separate transmittal for each submittal.
- G. **Deviations:** Clearly and distinctly denote any from the Contract Documents in submittals.

1.5 **Shop Drawings**

- A. Shop drawings submitted for this work shall make particular note of field-measured dimensions, as-built conditions, and conditions requiring special coordination with other contractors and the requirements of the activities of the City of Aurora Project Manager.
- B. **Subcontractor:** Submit digital files (e.g PDF files) of shop drawing sheets and specified number of Samples to the Contractor.
- C. **Contractor:**
 - 1. Review all Shop Drawings for accuracy, completeness, and conformity with the Contract Documents. Make notes and corrections on sepia tracings and prints, and stamp with Contractor's stamp/date. Signature of individual who reviewed the Shop Drawings is required and located below the Contractor's stamp.
 - 2. Print as required for Contractor's record.
 - 3. Submit to City of Aurora Project Manager.
 - 4. Shop Drawings not stamped and signed by the Contractor will be returned.
- D. **City of Aurora Project Manager:**
 - 1. Check drawings by making notes and corrections on electronic files or prints, stamp "No Exceptions Taken", "Revise and Resubmit", "Rejected", etc. as required.

2. In the event that the Shop Drawings require a consultant's check, route prints through City of Aurora Project Manager as necessary.
 3. Return marked digital file (e.g. PDF's) to Contractor.
- E. **Contractor:** Provide digital files to Subcontractor.
- F. **Subcontractor:** File necessary copies for record, distribution, etc.
- G. **Resubmittal:** In the event Shop Drawings have to be resubmitted to City of Aurora Project Manager, electronic file(s) with mark ups shall be returned directly to Contractor. Subcontractor shall make his/her correction and re-route new files as outlined above.
- H. **References:** Reference Shop Drawings to applicable Drawings and Specifications Sections to facilitate ease and accuracy of checking.

1.6 **Product Data**

- A. **Subcontractor:** Submit brochure material and required samples, unless otherwise noted by the Technical Specification Section.
- B. **Routing:** Routing will be as indicated above for Shop Drawings with the City of Aurora Project Manager, Consultant, and Sub-consultant. Electronic document to be returned to the Contractor for his/her file and shall be distributed back to the Subcontractor for file as applicable.
- C. **Reference:** Reference product data to applicable Drawings and Specification Sections to facilitate ease and accuracy of checking.
- D. When contents of submitted literature from manufacturer includes data not pertinent to the submittal, clearly indicate which portion of the contents is being submitted for review.

1.7 **Job Site Documents**

Only accepted Shop Drawings or Product Data shall be kept at the job site. Keep a complete set of such documents on file at the job site.

1.8 **Field Measurements**

Required field measurements are the responsibility of the Contractor.

1.9 **Samples**

- A. The City of Aurora Project Manager will provide the Contractor with a checklist indicating all materials where color, texture or finish is subject to selection by the City of Aurora Project Manager. The City of Aurora Project Manager in preparation of color and material sample presentations will request other samples for use for the City.
- B. Promptly after receipt of checklist, assemble and deliver to the City of Aurora Project Manager complete collection of all required samples. Unless otherwise specified, submit samples in quantity, which is required to be returned, plus one, which will be retained by the City of Aurora Project Manager.

- C. Samples shall bear a tag or label providing the following information:
1. Project name and location.
 2. Manufacturer, supplier.
 3. Name, finish, and composition of material.
 4. Location of where material is to be used.
 5. Specification Section number.
- D. Upon receipt of such a complete collection of samples, the City of Aurora Project Manager, with reasonable promptness, will make the selections and prepare and deliver to the Contractor a schedule covering all items subject to selection. The City of Aurora Project Manager reserves the right not to make individual determination or selections until all samples of all materials are furnished.

1.10 Certificates of Compliance

Where certificates of Compliance are specified, show on each certification the name and location of the work, name and address of Contractor or supplier, quantity and date or dates of shipment or delivery to which the certificate applies, and names of the manufacturer. Certification shall be in the form of a letter or company standard form. An officer of the manufacturer shall sign certificates. In addition, all laboratory test reports submitted with Certificates shall show date of testing, specified requirements for which testing was performed, and results of tests.

1.11 As Built Drawing

See Project Closeout Specification 01700 for preparation and submittal of as-built drawings of irrigation and any other portion of project constructed different from plans.

PART 2 PRODUCTS

Not used.

PART 3 EXECUTION

Not used.

END OF SECTION

TREE PROTECTION
01530

PART 1	GENERAL	1
1.1	Description of Work	1
1.2	Definitions	1
PART 2	PRODUCTS.....	1
2.1	Materials	1
PART 3	EXECUTION.....	1
3.1	Soil Excavation Around Trees	1
PART 4	MEASUREMENT AND PAYMENT	2
4.1	Measurement and payment.....	2

TREE PROTECTION
01530

PART 1 GENERAL

1.1 Description of Work

- A. This work shall consist of taking the necessary precautions to protect any trees within the project.

1.2 Definitions

- A. **Tree Protection Zone:** The Tree Protection Zone is a critical root zone and shall be a disturbance free area. A Tree Protection Zone shall be established for each tree 4" in caliper and greater that is to be preserved and protected by the City of Aurora Policy on Preservation of Existing Trees. Caliper shall be defined as the maximum diameter of the trunk 4.5' above the ground. The Tree Protection Zone shall be a circle with a radius relative to the caliper of the tree. The radius shall be one linear foot in length for each inch of tree caliper and the center of the circle shall be the trunk of the tree. (For Example: If the tree has a trunk twelve inches (12") in diameter then the disturbance free zone shall have a radius of twelve feet (12') from the center of the tree.)
- B. **Disturbance Trenching:** Disturbance trenching shall be defined as any changes in grade either cut or fill, material or equipment storage, equipment movement, compaction or paving.

PART 2 PRODUCTS

2.1 Materials

- A. "Orange" safety fencing is required for use in tree protection and is to be installed around the tree protection zone of all trees designated for protection. Fencing shall be maintained daily, and remain in place until project completion. A minimum of five (5) metal T-stakes per tree shall be used to delineate the Tree Protection Zone.

PART 3 EXECUTION

3.1 Soil Excavation Around Trees

- A. Equipment of any kind is prohibited from operation within the Tree Protection Zone of all trees – this includes vehicle parking and foot traffic.
- B. Stock piling of soil or materials is prohibited within the Tree Protection Zone of all trees.
- C. Compacting of the soil is prohibited within the Tree Protection Zone of all trees.
- D. Trenching and excavation is prohibited within the Tree Protection Zone of all trees, unless approved prior to construction.
- E. Any root pruning that is approved within the Tree Protection Zone shall be performed with a sharp tool and a clean cut.
- F. Roots shall not be exposed to the air for more than two to four (2-4) days, in order to avoid drying out and death.

- G. Limb damage is prohibited, unless approved prior to construction or as authorized by the City Forestry Division. Pruning of interfering limbs shall be done prior to construction and must be accomplished by a company licensed to perform tree work within the City of Aurora. A list of authorized companies can be obtained from the City of Aurora Forestry Division.
- H. Damage to the main trunk of the tree is prohibited. Damage greater than ten percent (10%) of the main trunk, not resulting in structural damage shall result in a fine based on the percentage of the circumference affected. Damage greater than thirty percent (30%) of the circumference of affecting structural integrity of the tree will result in a fine equal to the full-appraised value of the tree.
- I. All concrete washout areas must be designated – they shall not flow into or across the Tree Protection Zone.
- J. If irrigation is interrupted for more than one week, trees will require supplemental watering methods. Water should be evenly distributed within the critical root zone. As a rule, ten (10) gallons of water per one inch (1”) of trunk diameter should be administered.

PART 4 MEASUREMENT AND PAYMENT

4.1 Measurement and Payment

Tree Protection will not be paid separately, but will be included in the cost of the Base Bid.

END OF SECTION

TRAFFIC CONTROL
01570

PART 1 GENERAL 1

- 1.1 Description of Work 1
- 1.2 Prior to Construction 1
- 1.3 During Construction 1
- 1.4 After Construction 3
- 1.5 Traffic Signals 3

PART 2 MEASUREMENT AND PAYMENT 3

- 2.1 Measurement And Payment 3

TRAFFIC CONTROL
01570

PART 1 GENERAL

1.1 Description of Work

Traffic Control shall consist of furnishing and maintaining all barricades, signs, traffic control devices, detours, temporary pavement, or personnel to conduct pedestrian, bicycle and vehicular traffic safely through or around the construction site in conformity with these specifications and the Manual on Uniform Traffic Control Devices (MUTCD) and the Colorado Supplement thereto.

1.2 Prior to Construction

- A. The Contractor shall contact Traffic Operations Division at least seven (7) days before starting work on any arterial street, or within four hundred (400) feet of a traffic signal, to secure locations of any underground facilities. The Contractor shall be responsible for the cost of repair to any such facilities damaged by his/her construction. Phone Numbers are: Traffic Operations Division 303-326-8200, Signal Locates 303-326-8200, Fax 303-326-8238.
- B. The Contractor shall submit a traffic control plan approved by the Project Manager to Traffic Engineering through the Permit Center process for review and approval at least ten (10) business days before the start of work. Failure to provide a traffic control plan or obtain permission from Traffic Engineering may result in immediate work stoppage. If the Contractor desires to revise an approved traffic control plan, the revision proposal shall be submitted to Traffic Engineering through the Permit Center Process for review.
- C. Unless otherwise indicated on the plans, when construction is likely to interfere with or damage an official traffic control sign or device, the Contractor shall notify Traffic Operations Division seven (7) days in advance to have the sign or device retrieved or relocated. Once construction has been completed, Traffic Services shall require two working days notice for resetting the signs or devices prior to opening the project to traffic. The Contractor will be responsible for any repairs or replacement of any sign or device missing or damaged.

1.3 During Construction

- A. The Contractor shall not interfere with traffic 5:00 p.m. to 7:00 a.m. for local streets and 3:30 p.m. to 8:30 a.m. for collector/arterial streets on weekdays or at any time on weekends or holidays without permission from Traffic Engineering.
- B. The Contractor shall provide a traffic control person, other than the Project Superintendent, when called for in the plans or in the special conditions, or when determined necessary by Traffic Engineering. The Traffic Control Person shall have:
 - 1. Traffic control as his/her primary duty
 - 2. Carry a valid Traffic Control Supervisor certificate and a valid Flagging certificate (recognized by the Colorado Department of Transportation)
 - 3. Be on the job site at all times during working hours. Check all traffic control devices before and after the a.m. and p.m. rush hours, and periodically throughout the remainder of the day and night;

4. Verify that all traffic control devices are in accordance with the Manual on Uniform Traffic Control Devices, including the Colorado Supplement, and that all traffic control devices are properly positioned and operating according to the approved traffic control plans, or as directed by Traffic Engineering
 5. Maintain two-way traffic on existing pavement unless otherwise specified by Traffic Services. Be on-call twenty-four (24) hours per day and provide home and emergency phone numbers to Traffic Engineering.
 6. Be on-call 24 hours per day and provide home and emergency phone numbers to Traffic Engineering.
- C. When traffic control is required within a signalized intersection involving an arterial, there shall be a minimum of two off-duty uniformed City of Aurora police officers required. On all other signalized intersections, only one off-duty uniformed City of Aurora police officer will be required, unless otherwise specified by Traffic Engineering. Requests for officers may be made through the Secondary Employment Office of the Aurora Police Department at 303-739-6269 or 303-739-6268, at least five days before needed. The Contractor is to specify dates, hours, and the number of officers required. Cost of officers will be at the Contractor's expense.
 - D. The Contractor shall not allow construction equipment, personal vehicles, or construction materials to remain on or near the traveled lanes, sidewalks, trails or at any location that may interfere with the safe movement of traffic.
 - E. The cut or fill resulting from construction adjacent to traffic lanes shall be temporarily sloped and shall have vertical hazard panel delineators with steady-burn lights at the intervals specified on the traffic control plan, immediately behind grading and removal operations, in order to safeguard the traveling public. Any cut or fill two (2) inches or greater in depth within five (5) feet of a travel lane will require vertical panels for edge-line delineation.
 - F. The Contractor shall provide access, acceptable to the property owners, to existing driveways of businesses and homes in the project area.
 - G. The Contractor shall remove all dirt, mud, and debris from the travel lanes daily.
 - H. Construction traffic control signs or devices not in use shall be removed from the pedestrian walkway (sidewalk). Laying the sign down in a horizontal position or turning the sign parallel is not permitted on the sidewalk. For locations that do not have sufficient right-of-way available to store the sign(s) or device(s), they must be picked up or moved to an approved storage area. Signs that are placed in the medians must be dismantled or laid down. Turning of the sign(s) is not permitted. Sign(s) or device(s) left out facing traffic after work hours will be confiscated. The Contractor will be responsible for the cost of removing the sign(s) or device(s), at a minimum charge of thirty-five dollars (\$35.00) per sign or device, and will be responsible for picking up the confiscated material.
 - I. **Directional Arrow Boards:** Any four or six-lane arterial street lane closure that exceeds one hour will require one directional arrow board per lane direction closed. Requirements on all other streets will be determined by the Traffic Manager.
 - J. **Open Pits and Trenches:** Open pits and trenches will not be allowed on city streets, sidewalks or trails without advance approval from Traffic Services. They will be backfilled daily or they may be covered with steel plates. Note: steel plates three-quarter inch (3/4") thick minimum may not be used once the temperature reaches the freezing zone or any time in the winter.

- K. Installation and removal of temporary signing and striping shall be the responsibility of the Contractor.

1.4 After Construction

- A. Unless otherwise shown in the plans, the City of Aurora shall be responsible for all final lane marking and signing which are to be in place prior to opening the project area to traffic. Traffic Services shall require two working days notice for resetting signs and three working days notice for striping.
- B. Installation and removal of temporary striping and signing shall be the responsibility of the Contractor.

1.5 Traffic Signals

When a construction project includes the relocation of any traffic signal equipment or construction of a new signalized intersection, the work will be done by a qualified signal contractor to the specifications of Traffic Services.

PART 2 MEASUREMENT AND PAYMENT

2.1 Measurement And Payment

- A. Traffic control work shall be measured and paid for at the lump sum price as bid in the Proposal. The price bid in the Proposal shall include the cost of furnishing all labor, equipment and materials necessary for completing the work as specified. Traffic control shall be paid for on the percentage of completion at the time of the pay request.
- B. Traffic control shall include all costs for temporary barricades, flagmen, and other traffic control devices required during construction.

END OF SECTION

PROJECT CLOSEOUT
01700

PART 1 GENERAL..... 1

1.1 Requirements Included..... 1

1.2 Final Cleaning..... 1

1.3 Project Record Documents/As Built Drawings 1

1.4 Warranties and Bonds 2

1.5 Spare Parts and Maintenance Materials 2

1.6 Permit Closeout and Records..... 2

1.7 Substantial Completion..... 2

1.8 Final Completion..... 3

1.9 Final Payment..... 3

1.10 Final Acceptance 4

PROJECT CLOSEOUT
01700

PART 1 GENERAL

1.1 Requirements Included

- A. Final Cleaning.
- B. Project Record Documents/As Built Drawings.
- C. Warranties and Bonds.
- D. Spare Parts and Maintenance Materials.
- E. Permit Closeout and Records.
- F. Substantial Completion.
- G. Final Completion.
- H. Final Payment.
- I. Final Acceptance.

1.2 Final Cleaning

- A. Prior to review for Substantial Completion, the Contractor shall remove construction facilities, surplus construction materials, construction debris, survey stakes, adjust irrigation heads and perform all other maintenance described in the Maintenance Specification 01900.
- B. Prior to review for Final Completion, the Contractor shall do the same for the areas that were not complete at Substantial Completion.
- C. Prior to review of Final Acceptance, the Contractor shall remove, to a depth not less than three inches (3") below top of soil, all tree staking or guying material that is above ground or may cause injury to users. This shall be done in a manner that does not cause damage to any portion of the project. The Contractor shall also prune or replace all dead plant material at no additional cost to the owner and perform all other maintenance described in the Maintenance Specification 01900 that applies to the specific maintenance agreement.

1.3 Project Record Documents/As Built Drawings

- A. Maintain on site, separate from documents used for construction, one complete set of Contract Documents as Record Documents or As Built Drawings with all deviations from the original recorded hereon (layout and grades included). Keep documents current. Do not permanently cover work until information is recorded. These record drawing must be kept for all irrigation systems and any portion of the project that may be built differently than the plans define.
- B. Include all Change Orders.
- C. Reference dimensions are required to locate elements that do not extend above grade. Measure and provide reference dimensions from at least two (2) reference points that will be easily identifiable in the finished work.
- D. Prior to Contract Closeout, Contractor shall provide a digital file of the contract plans showing all changes accurately. Final payment will not be released prior to receipt of this file. Use the Record Drawings maintained on site to create the digital file of the As-Built Drawings.
- E. Label each sheet "Record Drawing". On the first sheet, the Contractor or resident superintendent shall execute the following statement:

Having reviewed this document and all attachments, I affirm that, to the best of my knowledge, the information presented here is true and accurate.

Signed _____ Date _____

Position _____

1.4 Warranties and Bonds

See General Conditions.

1.5 Spare Parts and Maintenance Materials

Provide spare parts and maintenance materials in quantities specified in each specification section. Coordinate delivery and storage with Project Manager.

1.6 Permit Closeout and Records

The Contractor shall closeout permits filed with any governing agency and turn over any appropriate reports to the Project Manager to be on record with the City of Aurora. This shall include but not be limited to any State of Colorado storm water or erosion control permits. The Contractor shall maintain accurate records as required by any governing agency for the specified amount of time. This shall include but not be limited to any storm water retention and water quality treatment records such as weekly and storm event BMP inspection reports, resolution repair reports, site photos or maps documenting various stages of BMP's that were used on site, violation records, approved reports. All inspections and repairs require documentation and all documentation is required by the State of Colorado Law to be kept on file for three years after the final stabilization of the site. Contact the Aurora Water (Department) Environmental Specialist at 303-739-7480 for any additional information. If Contractor has not fulfilled the requirements of any such permits, the permit(s) shall remain open until such time requirements are met. Contractor shall pay annual permit fees until requirements are satisfied.

1.7 Substantial Completion

A. **Definition:** The functional and aesthetic qualities of the work are important to the intended use. Therefore, Substantial Completion shall not be awarded until the City of Aurora can utilize the project area for the purpose for which it was intended as determined by Project Manager and all elements that create each site's aesthetic quality are installed in a manner that produces the intended appearance.

B. Procedure:

1. When Contractor is of the opinion that the work is substantially complete, submit written request for Substantial Completion review.
2. Project Manager will review the site with the Contractor within ten (10) business days of the request. If Project Manager determines that all major work elements have been completed and the City of Aurora can utilize the project area for the purpose for which it was intended, then the work is substantially complete and a "Certificate of Substantial Completion" will be issued, fixing the date of Substantial Completion. If the Project Manager determines the project to be substantially complete then, based on this review a list of deficiencies to be corrected will be issued to the Contractor soon after the review.

3. If the project was not determined substantially complete at the first review as described above, then the Contractor shall correct deficiencies within ten (10) days and upon completion of deficiencies, request compliance review.
4. Project Manager will review the site with Contractor within ten (10) business days of the second request for Substantial Completion review. If Project Manager determines deficiencies are corrected and if no other deficiencies are revealed by the review, then the work is substantially complete and a "Certificate of Substantial Completion" will be issued fixing the date of Substantial Completion.
5. If Project Manager determines that the work is not substantially complete at the time of second substantial completion review or that deficiencies remain at time, the Contractor shall pay for the additional review(s) by the Project Manager necessary to obtain Substantial Completion.

1.8 Final Completion

A. **Definition:** Final Completion shall not occur until installation required by the contract documents is one hundred percent (100%) complete as determined by the Project Manager.

B. **Procedure:**

1. When Contractor is of the opinion that the work is finally complete and list of deficiencies generated during the Substantial Competition review are corrected, submit written request for Final Completion review.
2. Project Manager will review the site with the Contractor within ten (10) days of the request. If Project Manager determines that all deficiencies are corrected and if no other deficiencies are revealed by the review and the project is complete, a "Certificate of Final Completion" will be issued, fixing the date of final completion. If Project Manager determines deficiencies are not corrected or if other deficiencies are discovered upon review, then the Project Manager will issue a new list of deficiencies to be corrected
3. Contractor shall correct deficiencies within ten (10) days and upon completion of deficiencies, request compliance review.
4. Project Manager will review the site with Contractor within ten (10) days of the second request. If Project Manager determines that all deficiencies are corrected and if no other deficiencies are revealed by the review and the project is complete, a "Certificate of Final Completion" will be issued, stating that no exception is made to the execution of the work and fixing the date of final completion.
5. If the Project Manager determines that the work is not complete at time of second final completion review or that deficiencies remain, the Contractor shall pay for the additional review(s) by Project Manager in order to obtain Final Completion.

1.9 Final Payment

- A. After a Certificate of Final Completion has been received, Contractor shall submit written request for a final payment in the amount of the retainage.
- B. In addition to submittals required by the conditions of the contract, the Contractor shall provide submittals required by governing authorities, and submit a final statement of accounting giving total adjusted contract sum, previous payments, and sum remaining due.

1.10 **Final Acceptance**

- A. **Definition:** The functional and aesthetic qualities of the work are important to the intended use. Therefore, Final Acceptance shall not be awarded until the Project Manager has determined that the project was built properly, and the functional and aesthetic qualities of the project have been retained after time of testing so that the City of Aurora can utilize the project area for the purpose which it was intended. The purpose of the warranty time frame is to ensure that every tree, plant or blade of grass has survived and recovered from both weather extremes of the year. See the Warranty Specification, Section 01800.
- B. Final Acceptance review shall occur thirty (30) days prior to the end of the 2-year Warranty/Maintenance period. Testing of the irrigation system should occur earlier if it will be shut down prior to this date. Final Acceptance cannot be awarded until the irrigation system can be tested to the satisfaction of both the Project Manager and the Contractor.
- C. **Procedure:**
1. Thirty (30) days prior to the end of the Warranty period, Contractor shall submit written request for Final Acceptance review.
 2. The Project Manager will review the site with Contractor within ten (10) business days of the request.
 3. If Project Manager determines that all work is in compliance with the contract drawings and specifications, a "Certificate of Final Acceptance" will be issued on the final day of the 2-year Warranty/Maintenance Period.
 4. If Project Manager determines that all work is not in compliance with the contract drawings and specifications, a list of deficiencies to be corrected will be issued to the Contractor soon after the review.
 5. The Contractor shall correct deficiencies within ten (10) days and upon completion of deficiencies, request compliance review.
 6. Project Manager will review the site with Contractor within ten (10) business days of the second request for Final Acceptance review. If Project Manager determines that all repairs and modifications have been completed and all work is in compliance with the contract drawings and specifications, a "Certificate of Final Acceptance" will be issued on the final day of the 2-year Warranty/Maintenance Period or on the date of the review, whichever is later.
 7. If Project Manager determines that all work is not in compliance with the contract drawings and specifications, the Contractor shall pay for the additional review(s) by the Project Manager necessary to obtain Final Acceptance.
 8. After a Certificate of Final Acceptance has been received, Contractor shall submit written request for a final payment in the amount of the retainage.

END OF SECTION

WARRANTY
01800

PART 1 GENERAL 1
 1.1 Description of Work 1

PART 2 PRODUCTS 2
 2.1 Materials 2

PART 3 EXECUTION..... 2
 3.1 Plant Replacements as Part of the Warranty..... 2
 3.2 Irrigation System Work as Part of the Warranty 2

PART 4 MEASUREMENT AND PAYMENT 3
 4.1 Measurement and Payment..... 3

WARRANTY
01800

PART 1 GENERAL

1.1 Description of Work

- A. This section covers warranty work that includes all improvements in the contract. The Contractor shall supply all labor, materials and equipment necessary to warrant all work as specified herein.
- B. During the Warranty Period, the Contractor shall provide a written monthly inspection report which documents the following:
 - 1. Name of Project
 - 2. Date and time of Inspection
 - 3. Weather conditions
 - 4. Condition of Plant materials
 - 5. Condition of non-living improvements
 - 6. Actions taken by Contractor
 - 7. Actions to be performed by Contractor at a later date
 - 8. Actions which Contractor recommends/requests the City to take
 - 9. Other pertinent observations and information.
- C. Warranty work includes the repair or replacement of all materials or related work during the warranty period at no additional cost to the City. The Contractor shall execute all replacements and/or repairs within thirty (30) days of notice by the City. The Contractor shall notify the City Project Manager upon completion of remedial work for re-inspection. The Contractor shall not be issued Certification of Final Acceptance until all work performed by Contractor is completed in accordance with the Contract Documents.
- D. All work during the warranty period shall be subject to observation by the City of Aurora Parks, Recreation and Open Space Department. Three (3) formal warranty inspections will be conducted during this period. The Project Manager will determine times of inspection. The Contractor shall be notified in writing of any workmanship or materials deemed by the City of Aurora Project Manager to be faulty or not satisfactory. The Contractor shall respond in writing to City of Aurora Project Manager within three (3) working days of receipt of the written notice. The Contractor shall repair and/or replace any such deficiencies within ten (10) working days or less if notified in writing by City to do so, of receipt of notice by the City. The Contractor shall notify the Parks, Recreation and Open Space Department in writing when the problems have been corrected.

1.2 Warranty Period

- A. Warranty period, except for seeded areas, shall be twelve (12) months following date of Substantial Completion. If Contract Documents state a longer period of time for specific project elements, the longer period shall govern.
- B. Warranty period for seeded areas shall be from date of Germination Acceptance until date of Final Acceptance. See Section 02480 Seeding & Sodding for requirements associated with Final Acceptance. For projects with City of Aurora Stormwater Permits, seeding Final Acceptance requirements shall be satisfied before Stormwater Permit is released, regardless of when contract is closed out.

PART 2 PRODUCTS

2.1 Materials

- A. For all other materials and elements not included in this specification, but required to comply with this warranty specification, refer to the Specification Sections related to those materials and elements.

PART 3 EXECUTION

3.1 Plant Replacements as Part of the Warranty

- A. During the warranty period, plant replacements will be considered a continuing process as necessary to keep the full number of plants in vigorous growth. Dead and dying trees, shrubs, and perennials, shall be replaced within one (1) month of plant's death and during approved planting period. Dead plant materials shall be replaced with same species, size and quantity as originally specified in the Contract, and shall be furnished, planted and maintained per specifications and details at no additional expense to Owner.
- B. Contractor shall notify the Project Manager immediately when conditions beyond his/her control have affected (or will affect) the health of the plant material or have damaged site elements.
- C. Vandalism or Accidental damage, not resulting from Contractor's negligence or operations, shall be reported to City Project Manager within three (3) working days of occurrence together with an estimate of costs for repairs. This applies also to changes and additions needed.

3.2 Irrigation System Work as Part of the Warranty

- A. Any defects to irrigation equipment or installation of the equipment and/or damages to irrigation system caused by Contractor's operations shall be repaired without charge to the City. Repairs shall be made prior to the next watering cycle.
- B. Vandalism or Accidental damage, not resulting from Contractor's negligence or operations and not included in the warranty or maintenance agreement, shall be reported to City Project Manager, within three (3) working days of occurrence together with an estimate of costs for repairs based on the Supplemental Schedule of Unit Prices included in the Contract Proposal.
- C. Any settling of backfilled trenches, which may occur during the warranty period, shall be repaired without expense to the Owner, including complete restoration of all damaged property.
- D. In early spring, Contractor shall check all systems for proper operation. Lateral lines shall be flushed out after removing the last sprinkler head or two at each end of the lateral. All heads are to be adjusted as necessary for unimpeded coverage. This work shall be considered part of the warranty and included in the base bid.
- E. Advise owner to set and program automatic controllers for seasonal water requirements.
- F. In the fall, on or around October 15th, all systems shall be drained and winterized by the Contractor to the City's specification. This work shall be considered part of the warranty and included in the base bid. Contractor shall coordinate winterization with City of Aurora Parks Operations and Maintenance Division.

PART 4 MEASUREMENT AND PAYMENT

4.1 Measurement and Payment

- A. Measurement and payment for warranty work shall not be paid for separately, but shall be included in each specific Base Bid item.

END OF SECTION

MAINTENANCE
01900

PART 1	GENERAL	1
1.1	Period of Time	1
1.2	Work Included.....	1
1.3	Quality Assurance.....	2
1.4	Maintenance Schedule.....	2
PART 2	PRODUCTS	2
2.1	Herbicides.....	2
2.2	Pesticides	2
2.3	Materials.....	2
PART 3	EXECUTION	3
3.1	Irrigation	3
3.2	Weeding	4
3.3	Mulching	4
3.4	Disease and Insect Pest Control	4
3.5	Fertilizing	4
3.6	Pruning and Repair	4
3.9	Staking and Tree Wrap	5
3.10	Clean Up.....	6
3.11	Winter Irrigation Shut Down	6
3.12	Spring Irrigation Start Up.....	6
3.13	Vandalism & Accidental Damage	6
3.14	Snow & Ice Removal.....	6
3.15	Drainage Systems.....	7
3.16	Maintenance Contract.....	7
3.17	Termination of the Maintenance Contract.....	7
PART 4	MEASUREMENT AND PAYMENT	7
4.1	Measurement and Payment	7

MAINTENANCE
01900

PART 1 GENERAL

1.1 Period of Time

- A. **Basic Maintenance:** The Contractor shall be responsible for the maintenance of all work other than items mentioned herein until he/she is awarded Substantial Completion. The Contractor shall be responsible for proper maintenance and irrigation of new sod for not less than 30 days to establish an acceptable lawn. The Contractor shall be responsible for the maintenance of seeded areas until he/she is awarded Final Acceptance. The Contractor shall be responsible for the maintenance of any items determined not to be in compliance with contract documents at Substantial Completion until Final Completion.

- B. **Extended Landscape & Irrigation Maintenance (only applies if an alternate for these services, requested in the Bid Documents, is accepted):** Extended Maintenance shall be in effect for the period of time from Substantial Completion to Final Acceptance. See Project Closeout Specification 01700. All maintenance operations shall be performed by an A.N.A. certified landscape contractor.

1.2 Work Included

- A. Landscape maintenance shall include all necessary watering, cultivation, weeding, pruning, disease and insect pest control, protective spraying, straightening plants which lean or sag, adjustments of plants which settle or are planted too low, mowing of turf areas, replacement of mulch that has been displaced by erosion or other means, filling and or regrading eroded areas, reseeding or replanting any eroded or dead areas, repairing and reshaping of water rings or saucers in non-irrigated areas, cleaning of gutters, drain inlets, storm chases and other drainage systems, sweeping of paved areas adjustment of irrigation heads & other portions of the irrigation system; removal of tools, and equipment used in the execution of the contract at the end of each work day. Removal of all snow, ice, rubbish or waste, and any other procedure consistent with good horticultural practice necessary to insure normal, vigorous and healthy growth of all plant material are also part of this maintenance work.

- B. Winter Watering: Landscape maintenance shall include watering during the months between irrigation system shutdown and startup as needed to maintain the health of plants and to insure plants are alive when irrigation system is turned on and operating correctly.

- C. After Substantial Completion, the Contractor shall not be responsible for cleaning, pumping or replacement of restroom facilities, removal of user trash and replacement or repair of any portion of the project that Project Manager deems to be vandalism or accidental damage, not resulting from Contractor's negligence.

- D. During the Extended Maintenance Period, any replacement of plant material shall be the responsibility of the Landscape Contractor as part of the installation contract with exceptions as listed in the Landscape Installation Specification 02900.

- E. The landscape maintenance contractor shall purchase and maintain Contractor's general liability insurance in the amounts of one million dollars (\$1,000,000). Certification of such insurance shall be filed with the Owner prior to the commencement of the work.

1.3 Quality Assurance

- A. **Work Force:** Contractor's representative shall be experienced and A.N.A. certified in landscape maintenance and shall be available on a twenty-four (24) hour basis for emergency repairs.
- B. **Materials:** All materials used shall conform to the irrigation and landscape specifications (02810 and 02900).
- C. If upon notification by the City Project Manager action is not taken to correct any problems which affect safety, health of the plants, or property image the City Project Manager may take whatever action necessary to remedy the situation. All costs associated with such work shall be deducted from any payments due the Contractor.

1.4 Maintenance Schedule

- A. The maintenance contractor shall submit a maintenance schedule (including irrigation, mowing, weed control and fertilizing) to the Project Manager as part of the bid. Daily scheduling of maintenance activities shall be coordinated with the Project Manager.
- B. A weekly report shall detail all planned and periodic maintenance activities, and all materials and application rates.
- C. Any subcontractors shall be listed in the report including certification and insurance information.

PART 2 PRODUCTS

2.1 Herbicides

- A. Herbicides used shall be Roundup (glyphosate), Surflan (oryzalin), Riverdale/Triplet (dimethylamine salts) or approved equals.

2.2 Pesticides

- A. Pesticides used shall be categorized as "General Use" by the Environmental Protection Agency. Product selection must be in accordance with specific pest and host plant considerations. Application rates and method of application must be in accordance with product label instructions.

2.3 Materials

- A. For all other materials not included in this specification, but required to perform this maintenance specification, refer to the Landscape Installation Specification 02900, section 2.1 through 2.14 and the Seeding & Sodding Specification 02480.

PART 3 EXECUTION

3.1 Irrigation

- A. Landscape maintenance contractor shall maintain the irrigation system in good operating condition through weekly inspections of all system components and make repairs as necessary. This includes checking and verifying operation in each zone, the alignment of heads, rain sensors, controller, and check leaks. The Contractor shall program the irrigation clock as he/she determines to be necessary during the period that he/she is responsible for the construction, establishment and maintenance of the project, with the approval of the Project Manager. Adjustment of irrigation heads & other portions of the irrigation system shall be made as necessary.
- B. Landscape maintenance contractor shall make every effort to conserve water by adjusting the programming to allow for weather changes and growth seasons. Irrigation operations should be conducted between 6:00 p.m. and 10:00 a.m. unless other hours are requested or approved by the Project Manager. Water use restrictions are in effect from May 1st through October 31st.
- C. The irrigation system shall be used by the maintenance contractor for the watering program, but any failure of the system does not eliminate the Contractor's responsibility of maintaining the desired level of moisture necessary to maintain vigorous, healthy growth.
- D. The Owner shall provide on-site water for the execution and maintenance of this landscape & irrigation work to the Contractor at no expense. The Owner will monitor water usage and will require modifications to watering schedule if wasteful usage is apparent.
- E. The Contractor shall furnish all equipment necessary to distribute water from the source provided by the owner including but not limited to all pumps, valves, connections, nozzles, pipes, hose, irrigation equipment and portable tanks & vehicles necessary.
- F. Winter Watering: All trees and shrubs shall be irrigated monthly between irrigation system shutdown and system startup.
 - 1. Recommended Amount of Water: Contractor is responsible for providing the amount of water necessary to maintain trees in a healthy condition. Approximate amounts per application are as follows:
 - a. Trees: twenty (20) gallons
 - b. Groundcover areas: one inch (1") of water
 - c. Shrub: two to three (2-3) gallons
 - 2. Water shall be hand applied at a rate that allows the water to soak into the root zone and does not runoff.
 - 3. Do not irrigate when temperatures will fall below thirty (30) degrees within twenty-four (24) hours.
 - 4. Irrigation system may be used for the water application only when temperatures will remain above freezing for several days. Immediately following irrigation repeat the winter shut down procedure.
- G. If replacement of component parts in the irrigation system becomes necessary after normal use, and after the original period of warranty has expired (see Irrigation System for Parks Specification 02810, section 1.8), the Owner is responsible for the expense of these

replacement components, if there has been no mishandling of these items on the part of the maintenance contractor.

3.2 Weeding

- A. Maintenance contractor shall keep all planting areas (including tree rings) free from weeds and undesirable grasses by a method and by materials approved by the A.N.A, including pre-emergent spraying and hand removals. Visible weeds shall be removed to ground level. All areas shall be weeded at least once a month, unless directed otherwise by Project Manager.

3.3 Mulching

- A. Mulch shall be maintained at the proper depth per detail in all shrub beds, ground cover areas, annual beds, and tree rings according to the original drawings and specifications.
- B. Mulch displaced by erosion, wind, or irrigation activities shall be removed from all walks, drives, and turf areas and replaced in the beds.
- C. All bark mulch beds to be top dressed annually.

3.4 Disease and Insect Pest Control

- A. Inspect all plant material at least once a month to locate any disease or insect pest infestations. Upon the discovery of any disease or insect pest infestation, identify, or have identified, the nature or species of the infestation. A method of control in accordance with common A.N.A. standards shall be immediately implemented.
- B. Apply all pesticides and fungicides according to label directions and take any precautions necessary to protect people and any other plant material from the chemicals.
- C. Submit written document listing type, brand name and rate of application of herbicides and pesticides to be used.
- D. Contractor shall show proof of valid Colorado Pesticide Applicator Certificate prior to pesticide applications.

3.5 Pruning and Repair

- A. The amount of pruning shall be limited to the minimum necessary to remove dead or injured twigs and branches and to maintain safety in vehicular use areas. Pruning shall be done in such a manner as to not change the natural habit or shape of the plant. All cuts shall be made at the branch collar, leaving the swollen collar at the crotch but no stubs.

3.6 Native Seed Areas

- A. Weeding: The Contractor is responsible for keeping these areas free of weeds and debris. Weed control will be accomplished by mowing the site or by applying approved herbicides at any point in time when weed species become taller than eight inches (8") or prior to weed flowers opening so that seed heads never develop. When grass becomes taller than eight inches (8") above grade, mow at a height of six inches (6") above grade. One (1) herbicide treatment for broadleaf weeds shall be required after seed is established. For additional requirements, see Specification Section 02480, Seeding and Sodding.
- B. Erosion: The Contractor shall repair grades damaged by erosion to the elevations and contours

established by the drawings.

- C. Fencing, signs and barricades: The Contractor shall maintain all fencing, signs and barricades installed to protect seeded areas.
- D. Irrigation: Within irrigated seeded areas, the Contractor shall maintain the irrigation system and is responsible for proper and appropriate system operation to ensure the growth and health of seeded areas.

3.7 Turf

A. General

- 1. Mow at intervals so that no more than one-third (1/3) of the blade length or one inch (1") is removed at each mowing.
- 2. Mow grass areas in such a manner as to prevent clippings from blowing on paved areas, and sidewalks. Cleanup after mowing shall include sweeping or blowing of paved areas and sidewalks to clear them from mowing debris.
- 3. Mowing in a City of Aurora City Park that has passed Substantial Completion and is therefore open to the public shall be performed between 7:00am and 11:00 am. Mowing shall not occur on Saturday, Sunday or Holidays.
- 4. Edges of curbs and sidewalks shall be trimmed at least twice monthly.
- 5. Irrigation system shall be checked for damage and repaired following each mowing operation.

- B. **Seeded Turfgrass Areas:** Prior to germination acceptance, the Contractor is responsible for keeping these seeded areas free of weeds and debris. Weed control will be accomplished by mowing the site when weeds reach eight inches (8") or prior to weed flowers opening so that seed heads never develop. When grass becomes taller than three and one-half inches (3.5") above grade mow at a height of two and one-half inches (2.5") above grade. The Contractor shall increase these heights by one half an inch during July, August and September. Mow at intervals so that no more than one-third (1/3) of the blade length or one inch (1") is removed at each mowing.

- 1. Mow grass areas in such a manner as to prevent clippings from blowing on paved areas, and sidewalks.
- 2. Cleanup after mowing shall include sweeping or blowing of paved areas and sidewalks to clear them from mowing debris.

- C. **Sodded Turfgrass Areas:** Prior to Substantial Completion, the Contractor shall be responsible for maintenance of sodded turfgrass areas, including a minimum of two (2) mowings, not less than seven (7) days apart.

- 1. Mow at intervals so that no more than one-third (1/3) of the blade length or one inch (1") is removed at each mowing.
- 2. Mow grass areas in such a manner as to prevent clippings from blowing on paved areas, and sidewalks. Cleanup after mowing shall include sweeping or blowing of paved areas and sidewalks to clear them from mowing debris.

3.8 Staking and Tree Wrap

- A. Wrap deciduous tree trunks per planting details no later than November 1st. Before wrapping, Project Manager shall inspect tree trunks for injury, improper pruning, and insect infestation.
- B. Landscape Contractor shall remove all wrappings between April 15th and May 1st.

- C. When Contractor is of the opinion that Final Acceptance is less than thirty (30) days away contractor shall remove all stakes or guys installed as part of installation at no additional cost to the City of Aurora. Tree staking material shall not be removed more than thirty (30) days prior to Final Acceptance. The Contractor shall be responsible for the removal and disposal of this material regardless of maintenance responsibility.

3.9 Clean Up

- A. During the course of construction, excess waste materials shall be continuously and promptly removed at the end of each work day. During the period of maintenance responsibility trash shall be removed from all areas & trash cans emptied including all paper, plastic, glass and metal debris larger than one inch (1") in size once a week and immediately before mowing operations. The Contractor shall remove all trash and products of mowing from the site before 5:00 p.m. of the same day. All trash and debris shall be disposed of by Contractor. All paved pedestrian and vehicular areas shall be swept and kept clean at all times after substantial completion.

3.10 Winter Irrigation Shut Down

- A. When cold weather approaches and the chance for freezing conditions exist, the system should be drained after each use.
- B. Winter shut down procedure as follows:
 - 1. Shut water off at main gate valve.
 - 2. Open all manual drain valves.
 - 3. Blow out each section twice with compressed air.
 - 4. Set controller to cycle through each section the minimum time available, once a day through Winter months.

3.11 Spring Irrigation Start Up

- A. Spring start up procedure as follows:
 - 1. Close all manual drain valves.
 - 2. Slowly turn water on.
 - 3. Cycle through each station manually until all air has escaped the system.
 - 4. Check for leaks and proper alignment of heads.
 - 5. Repair and adjust system as required for proper operation.

3.12 Vandalism & Accidental Damage

- A. Prior to Substantial Completion, the Contractor shall be responsible for all repairs and replacements which are required due to vandalism, accidental damage, and extreme acts of nature.
- B. If the Extended Maintenance alternate is accepted, replacement of plants, irrigation parts, or other materials damaged due to accidental damage not a result of negligence on the part of the Contractor or due to vandalism shall not be included in the monthly fees but will be billed separately, per the terms of the proposal presented by the Contractor and approved by the Project Manager.

3.13 Snow & Ice Removal

- A. Remove all snow and ice from all paved pedestrian and vehicular areas.

3.14 Drainage Systems

- A. All gutters, drain inlets, storm chases and other drainage systems shall be kept clean and in proper working order at all times.

3.15 Maintenance Contract

- A. These terms and conditions herein outlined shall be attached and made a part of a maintenance contract with the Owner, if the Extended Maintenance alternate is accepted.

3.16 Termination of the Maintenance Contract

- A. If the Owner fails to make payment for a period of ninety (90) days without written clarification, the maintenance contractor may, upon twelve (12) additional days' written notice to the Owner, terminate the contract and recover from the Owner, payment for all work executed and for any proven loss sustained upon any materials, equipment, or tools, including reasonable profit and damages applicable to the maintenance contract.
- B. If the maintenance contractor defaults or persistently fails or neglects to carry out the work in accordance with the maintenance contract, the Owner, after twelve (12) days' written notice to the maintenance contractor, and without prejudice to any other remedy they may have, may make good such deficiencies and deduct the cost thereof, including compensation for additional services made necessary thereby, from the payment then or thereafter due the Contractor, or at their option, may terminate the contract.

PART 4 MEASUREMENT AND PAYMENT

4.1 Measurement and Payment

- A. No separate payments shall be due to Contractor for maintenance required prior to Substantial Completion.
- B. Payment for work described in paragraph 3.13, Vandalism and Accidental Damage, shall be based on an approved proposal itemizing time and materials with associated costs.
- C. If Extended Maintenance alternate is accepted, the Contractor may request payment for Extended Maintenance operations not more than once a month and request for payment shall not exceed the total without written approval from the City.

END OF SECTION

SITE PREPARATION
02100

PART 1 GENERAL.....	1
1.1 Description of Work	1
1.2 Quality Assurance.....	1
1.3 Project Conditions.....	1
PART 2 PRODUCTS	2
2.1 Materials.....	2
PART 3 EXECUTION	3
3.1 Disposal of Waste Materials.....	3
3.2 Cleaning	3
3.3 Clearing	3
3.4 Tracking Mud on City Streets	3
PART 4 MEASUREMENT AND PAYMENT	3
4.1 Measurement & Payment.....	3

SITE PREPARATION
02100

PART 1 GENERAL

1.1 Description of Work

- A. **Work Included:** The Contractor shall provide all labor, materials and equipment necessary to furnish and install all site preparation as required by the Drawings and Specifications. The work under this section includes but is not limited to: Disposal of existing waste materials, grasses and weeds, saw-cutting, demolition debris; removal and disposal of items indicated on drawings.
- B. **Related Work:** Earthwork Specification 02200; Landscape Installation Specification 02900

1.2 Quality Assurance

- A. Comply with all applicable local, state & federal requirements regarding materials, methods of work and disposal of excess and waste materials.
- B. Obtain and pay for all required inspections, permits and fees. Documents shall be available on-site upon request by the City of Aurora Project Manager. Provide notices required by governmental authorities.

1.3 Project Conditions

- A. **Protection of Utility Lines:** Information on the Drawings relating to existing utility lines and services is furnished as general information only and is not guaranteed to be accurate or complete.
 - 1. The Contractor shall at all times take the proper precautions to protect utilities, service lines, cables, conduits, sewers, tanks, and irrigation, the presence of which are known or can be determined by the examination of appropriate plans & maps available through the utility companies or the City as well as location of the utilities on site. Contractor shall contact the utility notification center of Colorado at 1-800-922-1987 and have all utilities on site located. If utilities, service lines, cables, conduits, sewers, tanks, or irrigation are to remain in place, provide adequate means of protection during earthwork operations.
 - 2. If these elements conflict with the proposed work the Contractor shall immediately notify the City of Aurora Project Manager. Do not permit heavy equipment such as trucks, rollers or bulldozers to damage these elements. Hand excavate, as required, to minimize the possibility of damage to underground these elements. The Contractor shall be responsible for the cost of repair of any damaged protect utilities, service lines, cables, conduits, sewers, tanks, and irrigation to the satisfaction of the City of Aurora Project Manager and the owner of the property damaged.
 - 3. When uncharted or incorrectly charted, underground piping or other utilities and services are encountered during site work operations, notify the applicable utility company immediately to obtain procedure directions. Cooperate with the applicable utility company in maintaining active services in operation.
- B. **Protection of Undisturbed Areas:** Construction fencing shall be installed where indicated on the approved plans and/or per direction of the Project Manager to separate construction

areas from undisturbed areas. Contractor shall maintain fencing throughout the duration of the project.

- C. **Protection of Existing Vegetation:** All existing vegetation lying outside of construction areas (delineated by construction fencing) shall be designated as protected. No construction traffic, staging, parking or access will be allowed through the protected areas.
 - 1. Any tree designated to remain shall be fenced in accordance with standard Parks, Recreation and Open Space tree protection details.
 - 2. If it is unavoidable to have construction activities (e.g. traffic, access, etc.) taking place within the drip line of a protected tree, contractor shall install geotextile fabric and a 12-inch deep layer of coarse wood chips over the root zone area to be impacted. Contractor shall maintain depth of wood chips and shall water the area monthly during the growing season (May to September). After construction is completed, all impacted areas shall be restored to condition indicated on plans.
 - 3. Pruning: Prior to construction, pruning shall be limited to limbs which interfere with the safe operation of vehicles or equipment. After construction, pruning shall be performed to remove only dead and damaged limbs. Pruning in open space should be sparingly and large dead limbs left for wildlife habitat.
- D. **Protection of Monuments:** Locate, protect and maintain benchmarks, monuments, control points and project engineering reference points. Re-establish disturbed or destroyed items at the Contractor's expense.
- E. **Protection of Miscellaneous Public & Private Installations:** The Contractor shall at all times take precautions for the protection of existing curbs, gutters, pavement, irrigation systems, manholes, catch basins, street intersections and all other public and private installations that may be encountered during construction. The Contractor shall be responsible for the repair of any damaged installations, public or private.
- F. **Site Drainage:** The Contractor shall maintain positive drainage into all existing drainageways. The project area shall be graded to smooth all uneven fill areas.
- G. **Construction Limit Line:** Contractor shall limit site disturbances to those areas that are graded and seeded according to the plan. If the contractor has concerns regarding any potential or required disturbance outside the construction limit lines in order to complete the work, contractor shall contact the project manager prior to such disturbance.
- H. Project limits shall be in conformance with City of Aurora erosion and sediment control requirements or as shown on plans.

PART 2 PRODUCTS

2.1 Materials

- A. **Materials & Equipment:** As selected by the Contractor, except as indicated.
- B. **Waste Material:** Waste material shall be defined as tree roots, broken concrete, asphalt, base course, steel rebar, plant material, or any other equivalent material as determined by the City of Aurora Project Manager.

PART 3 EXECUTION

3.1 Disposal of Waste Materials

Stockpile, haul from site, and legally dispose of waste materials and debris. All material exported from the site shall be properly covered to prevent loss of material during transport.

3.2 Cleaning

Upon completion of site preparation work, clean areas within contraction limits. Provide site clear, clean and free of materials, tools, equipment and debris and suitable for site work operations. Maintain vehicular routes to any disposal sites clear, clean and free of debris. On-site burning of materials is not permitted.

3.3 Clearing

Locate and suitably identify improvements indicated to remain. Clear and grub areas within the limit of construction line as required for safe access and execution of the work. Within the limit of construction line remove all grasses, vegetation and debris, except items indicated to remain.

3.4 Tracking Mud on City Streets

Per City of Aurora, City Code Section 40-20, it is unlawful to track or cause to be tracked mud or other debris onto City streets or rights-of-way unless so ordered by the Engineer in writing. Daily clean up will be required on all streets which have been tracked due to construction.

3.5 Weed Pre-Treatment

Weeds occurring on the construction site, in areas that will be undisturbed and areas where topsoil will be salvaged for re-use, shall be treated with approved herbicide a minimum of seven (7) days prior to clearing and grubbing operations. Tall weeds which have bloomed and/or have viable seeds shall be cut down and removed from site in a manner that minimizes the spread of seeds.

PART 4 MEASUREMENT AND PAYMENT

4.1 Measurement & Payment

- A. Measurement for site preparation shall include clearing and grubbing of the landscape area and shall be on a lump sum basis and paid for at the contract price as bid in the contract.
- B. Contract price shall include the cost of furnishing all labor, equipment and materials necessary to complete the work as shown on the plans and called for in the specifications.

END OF SECTION

EARTHWORK
02200

PART 1 GENERAL.....	1
1.1 Description of Work.....	1
1.2 Quality Assurance	1
1.3 Job Conditions	1
PART 2 PRODUCTS	2
2.1 Water	2
2.1 Fill Material.....	2
2.2 Site Topsoil	2
2.2 Import Topsoil	2
PART 3 EXECUTION	3
3.1 Inspection	3
3.2 Site Topsoil Preservation.....	3
3.2 Excavation	3
3.3 Soil Storage	4
3.3 Compaction	4
3.4 Backfill & Fill.....	4
3.5 Grading	5
3.6 Field Quality Control	5
3.7 Maintenance	5
3.8 Disposal of Excess & Waste Materials.....	5
3.9 Tracking Mud on City Streets.....	6
PART 4 MEASUREMENT & PAYMENT	6
4.1 Measurement & Payment	6

EARTHWORK
02200

PART 1 GENERAL

1.1 Description of Work

- A. **Work Included:** The Contractor shall provide all labor, equipment and materials necessary to complete all import topsoil fill and fine grading, compaction and incidental earthwork as required by the Drawings & Specifications.
- B. **Related Work:** Site Preparation Specification 02100; Concrete Specification 03000.

1.2 Quality Assurance

A. **Codes & Standards:**

- 1. **Compaction standard:** Standard Proctor density ASTM D-698, under all concrete work. Eighty-five percent (85%) modified ASTM D-1557 on topsoil and topsoil subgrade.
- 2. **Testing & Inspection:** The City of Aurora shall conduct soil testing & earthwork inspections for quality control during earthwork operations.

1.3 Job Conditions

- A. **Existing Utilities & Irrigation:** The Contractor shall at all times take the proper precautions to protect utilities, service lines, cables, conduits, sewers, tanks, and irrigation, the presence of which are known or can be determined by the examination of appropriate plans & maps available through the utility companies or the City as well as location of the utilities on site. Contractor shall contact the utility notification center of Colorado at 1-800-922-1987 and have all utilities on site located. If utilities, service lines, cables, conduits, sewers, tanks, or irrigation are to remain in place, provide adequate means of protection during earthwork operations. If these elements conflict with the proposed work the Contractor shall immediately notify the City Project Manager. Do not permit heavy equipment such as trucks, rollers or bulldozers to damage these elements. Hand excavate, as required, to minimize the possibility of damage to underground these elements. The Contractor shall be responsible for the cost of repair of any damaged protect utilities, service lines, cables, conduits, sewers, tanks, and irrigation to the satisfaction of the City Project Manager and the owner of the property damaged.
- B. **Protection of Persons & Property:** Barricade open excavations occurring as part of this work and post warning lights. Operate warning lights as recommended by authorities having jurisdiction. Protect structures, utilities, sidewalks, pavements, and other facilities from damage caused by settlement, lateral movement, undermining, washout and other hazards created by earthwork operations.
- C. **Cold Weather Protection:** Protect excavation bottoms against freezing when atmospheric temperature is less than 35°F.
- D. See the Site Preparation Specification 02100 section 1.3.

PART 2 PRODUCTS

2.1 Water

Contractor is responsible for supplying all water necessary for earthwork operations. Water used shall be free of any mineral salt or contaminating materials which might result in expansion of materials after placement or inhibit plant life.

2.1 Fill Material

Fill material for use in parks and medians shall be composed of suitable materials. Suitable material shall be clean compactable earth, free from vegetation, frozen materials, debris, oversaturated soils and organic substances or any thing that may inhibit plant life. Soil materials must be approved by City Soils Engineer as suitable for intended use. Fill Material is not top soil see below.

2.2 Site Topsoil

Natural, friable, soil possessing the characteristics of representative topsoil in the vicinity which produces a heavy growth; free of stones over 1 inch in diameter, refuse, plants or their roots, sticks, noxious weeds, salts, soil sterilants, toxic substances or other material which would be detrimental to plant growth or hinder planting operations. There is no minimum amount or organic material required.

2.2 Imported Topsoil

- A. Shall be fertile, friable, sandy loam topsoil and shall be obtained from a well-drained site. It shall be without admixture of clay, subsoil, and shall be free of stones over one inch (1") in diameter, refuse, plants or their roots, stolons, seeds sticks, noxious weeds, salts, soil sterilants, toxic substances or other material which would be detrimental to plant growth or hinder planting operations.
- B. Imported topsoil shall not be delivered or used while in a frozen or muddy condition.
- C. Imported topsoil as delivered to the site shall have an acidity range of pH 6.0 to 7.5 and shall contain not less than 5% organic matter as determined by loss on ignition of moisture-free samples dried at 100D Centigrade. Topsoil shall have salt of less than 2 mmhos/cm and a sodium absorption ratio of less than 12.

D. Topsoil shall meet the following mechanical analysis:

	<u>Passing %</u>	<u>Retained %</u>
1-inch screen	100	0-3
½-inch screen	97-100	0-3
No. 100 mesh sieve	60-40	40-60

E. Topsoil shall meet the following component analysis from the USDA soils triangle.

<u>Soil Type</u>	<u>% of Sample</u>
Sand	55-80
Clay	0-20
Silt	20-45

F. Contractor shall submit a one pound sample of imported topsoil, along with a current analysis.

- G. The Project Manager reserves the right to inspect topsoil at its source to determine whether or not it meets the requirements specified and to approve the depth to which it may be stripped.

PART 3 EXECUTION

3.1 Inspection

- A. When the Contractor is prepared for one (1) of the required inspections, he/she shall give the Inspector and Project Manager twenty-four (24) hours notice to visit the site & perform the inspection. This does not preclude the right of the Inspector and Project Manager to make informal inspections at any time during the work of this Section. Nor does the Project Manager's inspection and approval of work in-progress impair the City's right to reject work upon Final Inspection. The required inspections for which the Contractor must notify the Inspector and City Project Manager are as follows:
 - 1. Subgrade Finish. The Inspector shall inspect the finished subgrade surface for conformance to these Drawings & Specifications immediately following completion of the work. Any workmanship deemed by the Inspector at this time to be faulty or not in accordance with these Drawings & Specifications, shall be corrected and reworked at this time.
 - 2. Finish Grade. The Project Manager and Inspector shall inspect the finish grade surface for conformance to the Drawings and Specifications following the completion of the work. Any deviations from the Drawings and Specifications shall be corrected at this time at the Contractor's expense.

3.2 Site Topsoil Preservation

Prior to any excavation activities and after clearing per Site Preparation Specification 02100 section 3.3, strip site topsoil to a depth of approximately 6" to be confirmed by the City Project manager. Site top soil must meet the requirements of section 2.2 of this specification. The results of the soil analysis must be reviewed prior to this process. See Landscape Installation Specification 02900 section 2.1.

3.3 Excavation

- A. **General Excavation:** Excavation of every description and of all substances encountered within the project limit shall be performed to the elevations and dimensions shown on the Drawings. In excavating, the Contractor shall use extreme caution not to excavate beyond the subgrade elevations.
- B. In the event that excavations are made below the subgrade elevations, the Contractor shall replace the excavated material in horizontal layers not to exceed eight inches (8") (loose measurement) as specified for embankments. If, in the excavation of any other area, subgrade material is encountered which, in the opinion of the Inspector is unsuitable, that material shall be excavated as necessary below the subgrade elevation and replaced with suitable material in horizontal layers not to exceed six inches (8") to provide a functional foundation.

- C. Do not allow water to accumulate in excavations. Remove water to prevent softening of foundation bottoms, undercutting of footings, and soil changes detrimental to stability of subgrades & foundations.
- D. Convey ground and rain water removed from excavations to and rain water to temporary sediment basins within the project limits. These basins shall be protected by temporary sediment control devices. Contractor shall obtain a state dewatering permit and if ground water is encountered before ground water may be removed from excavations. The Contractor may be required to obtain additional permits as well.
- E. Do not use trench excavations as temporary drainage ditches.

3.4 **Soil Storage**

- A. Contractor shall stockpile satisfactory excavated and imported soil materials where directed, until required for backfill or fill. Contractor shall place, grade and shape stockpiles for proper drainage.
- B. Locate and retain soil materials away from edge of excavations.

3.5 **Compaction**

A. **Percentage of Maximum Density Requirements:**

1. Topsoil areas which will be seeded shall not be allowed a higher compaction than seventy five percent (75%) modified Proctor density ASTM D-1557 within 12" of finish grade. In the event that a higher density is determined through field test, the Contractor shall be directed to scarify and regrade the over-compacted areas to the approved lines and grades.
2. Topsoil areas which will be sodded shall not be allowed a higher compaction than eighty five percent (85%) nor less than eighty percent (80%) modified Proctor density ASTM D-1557 within 12" of finish grade. In the event that a higher density is determined through field test, the Contractor shall be directed to scarify and regrade the over-compacted areas to the approved lines and grades.
3. Embankments for pavement, shall be thoroughly compacted by roller or vibratory equipment, for the type of embankment material, to a minimum of ninety-five percent (95%) density as determined by laboratory test ASTM D-698 after each layer and before the next lift is placed.

- B. **Moisture Control:** Maintain moisture content of fill or embankment material to within $\pm 3\%$ of optimum as determined by ASTM D-698. Where subgrade or layer of soil material must be moisture conditioned before compaction, uniformly apply water to surface of subgrade. Remove and replace, or scarify and air dry soil material that is too wet to permit compaction to specified density. Assist drying by discing, harrowing or pulverizing until moisture content is reduced to a satisfactory value.

3.6 **Backfill & Fill**

A. **Ground Surface Preparation:**

1. Remove any debris, unsatisfactory soil materials, obstructions, and deleterious mate-

rials from ground surface prior to placement of fills.

2. For all areas designated to receive pavement and requiring embankment material, the ground surface is to be broken up, pulverized, moisture-conditioned to the optimum moisture content and compacted to the required depth and density prior to placing fill.

- B. **Placement & Compaction:** Place backfill and fill materials in layers not more than eight inches (8") in loose depth for material compacted by heavy compaction equipment, and not more than four inches (4") in loose depth for material compacted by hand-operated tampers. Disc layers sufficiently to break down large clods. The Contractor shall thoroughly mix the materials to secure a uniform moisture content and density. Do not place backfill or fill material on surfaces that are muddy or frozen. Place backfill and fill materials evenly adjacent to structure, to required elevations. Take care to prevent wedging action or backfill against structures by placing the material uniformly around structures to approximately the same elevation in each lift.

3.7 Grading

- A. The proposed lines & grades shown on the Drawings are finish grades. The Contractor shall refer to the plans, sections and details for information to calculate subgrade elevations throughout the site.
- B. The surface of both subgrade and finish grade, after compacting, shall coincide with the required elevations being true to line and grade, smooth, dense, free of ruts, depressions and irregularities. The subgrade surface shall be maintained in a smooth and compacted condition.

3.8 Field Quality Control

- A. **Quality Control Testing During Construction:** All required compaction shall be inspected and tested by the City of Aurora, Materials Lab Manager or an approved geotechnical consultant. The City of Aurora shall pay for the initial testing. Should any compaction test fail, the Contractor shall pay for all further testing necessary in that area in order to achieve the required compaction.

3.9 Maintenance

- A. **Protection of Graded Areas:**
 1. Protect newly graded areas from traffic & erosion. Keep area free of trash and debris.
 2. The contractor shall repair & establish grades in settled, eroded and rutted areas as original designed to specified tolerances.

3.10 Disposal of Excess & Waste Materials

Remove excess excavated material, trash, debris & waste materials and dispose of it off of the property. See Site Preparation Specification 02100 section 3.1.

3.11 Tracking Mud on City Streets

- A. Per City of Aurora, City Code Section 40-20, it is unlawful to track or cause to be tracked mud or other debris onto City streets or rights-of-way unless so ordered by the Engineer in writing. Daily clean up will be required on all streets which have been tracked due to construction.
- B. All material imported to the site shall be properly covered to prevent loss of material during transport.

PART 4 MEASUREMENT & PAYMENT

4.1 Measurement & Payment

- A. Measurement and payment for earthwork (including cut, fill, import fill, export fill, spreading, compaction and rough grading) shall be paid on a cubic yard basis and paid for at the unit bid price in the contract OR shall be paid for at the lump sum bid price in the contract. *Choose accordingly*
- B. Measurement and payment for import topsoil (including purchasing, hauling, spreading, compaction and rough grading) shall be paid on a cubic yard basis and paid for at the unit bid price in the contract OR shall be paid for at the lump sum bid price in the contract. *Choose accordingly*
- C. Measurement and payment for on-site topsoil (including stripping, stockpiling, spreading, compaction and rough grading) shall be paid on a cubic yard basis and paid for at the unit bid price in the contract OR shall be paid for at the lump sum bid price in the contract. *Choose accordingly*

END OF SECTION

SEEDING AND SODDING
02480

PART 1 GENERAL.....	1
1.1 Description of Work	1
1.2 Quality Assurance.....	1
1.3 Submittals.....	1
1.4 Product Delivery, Storage and Handling.....	1
1.5 Job Conditions	2
PART 2 PRODUCTS	2
2.1 Grass Seed.....	2
2.2 Mulch.....	3
2.3 Erosion Control Fabric	3
2.4 Fertilizer.....	3
2.5 Organic Materials.....	3
2.6 Grass Sod	3
2.7 Native Seed Mix:	3
Part 3 EXECUTION.....	4
3.1 Inspection	4
3.2 Seed and Sod Bed Preparation.....	4
3.3 Fine Grading.....	4
3.4 Seeding	4
3.5 Mulch.....	4
3.6 Sodding	5
3.7 Fertilizer & Organic Materials	5
3.8 Erosion Control Fabric	5
3.9 Landscape Maintenance	5
3.10 Watering.....	6
3.11 Inspections & Acceptance for Sodding	6
3.12 Inspections & Acceptance for Seeding	7
3.13 Cleanup, Protection and Repairs.....	9
Part 4 MEASUREMENT & PAYMENT.....	10
4.1 Measurement & Payment.....	10

SEEDING AND SODDING
02480

PART 1 GENERAL

1.1 Description of Work

A. The seeding and sodding limits are defined on the drawings.

B. Related Work:

1. Site Preparation Specification 02100
2. Landscape Installation Specification 02900.

1.2 Quality Assurance

A. **Reference Standards:** U.S. Department of Agriculture, Rules & Regulations under Federal Seed Act quality standards for Certified Seed.

1.3 Submittals

A. **Certificate of Inspection:** Submit copies of invoices for materials, including seed, with State, Federal or other inspection certification and showing source of origin.

B. **Seed Tags:** Submit seed tags to the Project Manager prior to seeding.

C. **Seeding Schedule:** Seeding shall occur when weather and soil conditions are favorable or as authorized by the Project Manager.

1. The Contractor shall supply the City Project Manager with a seeding schedule establishing dates for the commencement and completion of each type of work. Correlate work to provide any maintenance required per the Maintenance Specification 01900 until maintenance responsibility has expired per the Maintenance Specification 01900.
2. Do not depart from the accepted schedule except with written authorization from the Project Manager. When delays in the seeding schedule are unavoidable, include documentation of reasons for delay. Maintenance periods will be adjusted to compensate for extension of time or work outside of time limitations.

D. **Maintenance Schedule and Process:** Submit proposed City seedbed maintenance schedule and process due at time of notice to proceed. Maintenance schedule will take affect after conditional acceptance.

E. **Materials Samples:** Organic material, including any required analysis, shall be submitted ten (10) days before delivery to the site.

1.4 Product Delivery, Storage and Handling

A. **Delivery Schedule:** Notify the Project Manager of delivery schedule not less than twenty-four (24) working hours in advance of delivery of each type of material.

B. **Seed:** Deliver seed in sealed standard bags or containers clearly labeled to show the name and address of supplier, correct seed name, composition, lot number, net weight, and guaranteed percent of purity and germination. The Contractor shall furnish to the Project Manager a signed statement certifying the seed is furnished from a lot that has been tested by a recognized

laboratory for seed testing within six (6) months prior to date of delivery. Seed that has become wet, moldy, or otherwise damaged in transit or in storage will not be acceptable. Unacceptable material will be removed from the job site immediately.

1.5 Job Conditions

A. **Utilities & Irrigation:**

1. The Contractor shall at all times take the proper precautions to protect utilities, service lines, cables, conduits, sewers, tanks, and irrigation, the presence of which are known or can be determined by the examination of appropriate plans & maps available through the utility companies or the City as well as location of the utilities on site. Contractor shall contact the utility notification center of Colorado at 1-800-922-1987 and have all utilities on site located. If utilities, service lines, cables, conduits, sewers, tanks, or irrigation are to remain in place, provide adequate means of protection during earthwork operations.
2. If these elements conflict with the proposed work the Contractor shall immediately notify the Project Manager. Do not permit heavy equipment such as trucks, rollers or bulldozers to damage these elements. Hand excavate, as required, to minimize the possibility of damage to underground these elements. The Contractor shall be responsible for the cost of repair of any damaged utilities, service lines, cables, conduits, sewers, tanks, and irrigation to the satisfaction of the Project Manager and the owner of the property damaged.

PART 2 PRODUCTS

2.1 Grass Seed

- A. Seed shall be labeled in accordance with the U.S. Department of Agriculture, Rules and Regulations and the Federal Seed Act. Seed shall be equal in quality to the standards for "Certified Seed" and shall be furnished in sealed, unopened, standard containers. Seed shall be fresh, clean, pure live seed with the following varieties, mixed in proportions by weight shown and meeting the minimum percentages of purity and germination specified.
- B. Seed shall be applied at a rate shown by mix. Seed shall pass government test for germination of eighty percent (80%) and for purity of ninety percent (90%). The Pure Live Seed shall not be less than sixty-seven and one-half percent (67.5%) for any one variety, with the average of the mixture, no less than seventy-two percent (72%). All seed shall be free of *Poa annua* and all noxious objectionable weeds with a maximum crop of one-tenth percent (.10%) and maximum weed of one-tenth percent (.10%). If seed available on the market does not meet the minimum purity and germination percentages specified, the Contractor must compensate by furnishing sufficient additional seed to equal the specified product. **See plan for native seed mixture(s) and rates.**
- C. Product comparison shall be made on the basis of pure live seed in pounds. The formula used for determining the quantity of pure live seed (PLS) shall be:
$$\text{Pounds of Seed} \times (\% \text{ Purity} \times \% \text{ Germination}) = \text{pounds of Pure Live Seed (PLS)}$$
- D. **Bluegrass Seed** blend shall contain four (4) of the varieties stated below or approved equal. The ratio shall be 25% each by weight.
- | | |
|-------------------|----------------------|
| Arcadia Bluegrass | Freedom II Bluegrass |
| Award Bluegrass | P105Bluegrass |
| Nuglade Bluegrass | Awesome Bluegrass |
| SR 2100 Bluegrass | Impact Bluegrass |

2.2 Mulch

- A. Mulch will be hydro mulch. See Hydro Mulching Specification 02550 for requirements.
- B. In areas seeded with native grasses, mulch may be hydro mulch or crimped, weed-free straw. Over 75% of straw shall be greater than ten(10) inches long. Hay shall not be used.

2.3 Erosion Control Fabric

- A. Erosion control fabric shall be a single net excelsior blanket enclosed in a photodegradable plastic mesh secured with steel wire staples 6 inches long. Install per manufactures specifications. Use "Curlex" single net blankets by American Excelsior Company or approved equal unless specified otherwise on the plans.

2.4 Fertilizer

- A. For areas of sod, see Landscape Installation Specification 02900 for fertilizer requirements.
- B. For areas seeded with native grass, fertilizer shall be Biosol Forte 7-2-1 by Rocky Mountain Bio Products.

2.5 Organic Materials

- A. See Landscape Installation Specification 02900 for soil amendment requirements.

2.6 Grass Sod

- A. Sod shall be a Kentucky Bluegrass blend from Turfmaster, Ft. Collins Colorado (970) 493-8311; Bittersweet Turf Farms, Roggen, Colorado (303) 659-5118; or approved equal. The blend shall contain four (4) of the varieties of Bluegrass seed listed below or approved equal. The ratio shall be 20-30% each by blade count

Arcadia Bluegrass	Freedom II Bluegrass
Award Bluegrass	P105 Bluegrass
Nuglade Bluegrass	Awesome Bluegrass
SR 2100 Bluegrass	Impact Bluegrass

- B. Sports Turf sod shall be a Kentucky x. Texas bluegrass hybrid. blend from Bittersweet Turf Farms, Roggen, Colorado (303) 659-5118; Graffs Turf Farms Fort Morgan Colorado (970) 867-8873; or approved equal.
- C. Sod shall be strongly rooted and free of noxious weeds, undesirable plants, roots, stones and other foreign materials that will be detrimental or will hinder the proper development of the sod. The sod shall be procured from areas where the soil is reasonably fertile and contains a high percentage of loamy topsoil. The sod shall be cut from living, thickly matted turf. The sod shall be mowed to a height not to exceed two inches (2") and thoroughly watered before lifting of the sod. All sod shall be cut to provide a minimum thickness of three-quarter inch (3/4") of soil adhering to the roots.
- D. Deliver sod to the site within twenty-four hours of harvesting and protect from drying out, exposure of roots to the sun, and other injury.

2.7 Native Seed Mix For native grass seed mix, see plans.

PART 3 EXECUTION

3.1 Inspection

- A. Contractor must examine the sub-grade, verify the elevations, observe the conditions under which the work is to be performed, and notify the Project Manager of unsatisfactory conditions. Do not proceed with work until unsatisfactory conditions have been corrected in a manner acceptable to the Project Manager.

3.2 Seed and Sod Bed Preparation

- A. **Sodded/Seeded Areas:** Spread specified amendment materials evenly over entire area and thoroughly incorporate, by mixing, rototilling or finely disking (max. 1" size), to a depth of six (6) inches. All stones, sticks and debris brought to the surface shall be removed from the site and properly disposed of by the Contractor at no additional cost to the Owner. All seed or sod areas will then be raked and rolled to the desired finished grades with gently sloping surfaces to adequately drain all surface water runoff. The finished surface shall be even and uniform, and no dirt clods larger than one inch (1") in diameter shall appear on the surface. The soil surface shall be smooth, loose and of fine texture, staying one inch below all paving edges for sod and flush for seed.

3.3 Fine Grading

- A. Grade disturbed areas to a smooth, even surface with a loose, uniformly fine texture. Roll, rake and remove ridges and fill depressions, as required, to obtain positive drainage. Limit fine grading to areas that can be seeded within five days.
- B. Moisten prepared areas before planting if soil is very dry. Do not create a muddy soil condition or cause surface erosion.
- C. Any damage to the seed or sod bed due to contractor operations or negligence, erosion, irrigation breaks, traffic, vandalism etc. that occurs before Establishment Acceptance will be repaired and restored at no additional cost to the City.

3.4 Seeding

- A. The Contractor shall use appropriate mechanical power (Brillion Seeder or equal) to drill the seed into the seedbed wherever possible. The drill shall be equipped with a satisfactory feeding mechanism, agitator, double discs, furrow openers, depth bans and packer wheels. Seed shall be sown to a depth of one-half inch (½"). Drilling shall be done in two (2) separate applications crossing the area at right angles to one another to guarantee proper coverage. On sloping land, the Contractor shall conduct seeding operations following the general contour. Areas too small to drill seed may be broadcast by hand and application rates shall be doubled. Seeding of any kind will not be permitted when wind velocity is such as to prevent uniform seed distribution. No application shall take place with the presence of free surface water or when the ground is frozen or cannot be tilled.

3.5 Mulch

- A. For hydro mulch, see Hydro Mulching Specification 02550 for requirements.
- B. Apply weed-free straw mulch uniformly over the area, in a continuous blanket, at a rate of 2500 lbs per acre. The mulch shall not be bunched. Immediately following spreading, the mulch shall be anchored to the soil by a v-type wheel land packer or a scalloped-disk land packer designed to

force the mulch in to the soil surface a minimum of 3 inches. A minimum of 70% of the straw shall be crimped into the soil. An approved tackifier can be applied over the mulch after crimping is complete.

3.6 Sodding

- A. Lay sod within twenty-four (24) hours from time of cutting. Do not plant dormant sod or if ground is frozen. The Contractor shall lightly sprinkle the sod bed just prior to laying sod. All sod strips shall be placed tightly against each other so no open joints are apparent. Joints between end of strips shall be staggered at least one foot (1') between adjacent rows. At the end of walks and drives, the sod shall have the same finish grade as the abutting surfaces. Immediately after the sod has been laid, it should be tamped or rolled with approved equipment, adequate enough to eliminate air pockets, providing a smooth and even surface to the sodded areas. Immediately following, sufficient water shall then be applied to saturate the sod completely. The sod, in addition, shall be watered as often as required to prevent it from drying out. Settled sod areas shall be pulled, re-graded and re-laid.

3.7 Fertilizer & Organic Materials

- A. **Soil Preparation:** The schedule of soil amendments for various project areas are listed below as a benchmark, **the project specific amendment schedule shall be determined by the Project Manager after review of an analysis of on-site top soil from a soil testing lab equipped to examine soil for horticultural use.** See site top soil analysis section of Landscape Installation Specification 02900.
1. Permanently Seeded Areas of Irrigated Dryland, Riparian & Wetland Native, Blends: Provide not less than the following quantities of specified amendment materials.
Organic Soil Amendment: 2 cubic yards per 1000 s.f.
 2. Permanently Seeded Areas of Non-Irrigated Dryland, Riparian & Wetland Native, Blends: Provide not less than the following quantities of specified amendment materials.
Organic Soil Amendment: 0 cubic yards per 1000 s.f.
Fertilizer (Biosol Forte 7-2-1): 800 lbs per acre
 3. Sodded and Permanently Seeded Areas of Bluegrass Blends: Provide not less than the following quantities of specified amendment materials.
Organic Soil Amendment: 4 cubic yards per 1000 s.f.
Commercial Fertilizer (20-10-5): 10 lbs. per 1000 s.f.
Superphosphate @ 20% P2O5: 10 lbs. per 1000 s.f.

3.8 Erosion Control Fabric

- A. Install erosion control fabric with wooden stakes where indicated on the plans. Metal pins are not allowed. Contractor can install, at his/her cost, additional erosion control fabric where approved by the Project Manager.

3.9 Landscape Maintenance

- A. See Maintenance Specification 01900 section 3.7. Areas seeded and maintained shall be protected against damage by the use of barriers and appropriate warning signs.

3.10 Watering

- A. The Contractor is responsible for the distribution of water from the source provided by the Owner. The Contractor shall apply water in a manner consistent with these specifications and deemed appropriate by the Project Manager. The Contractor shall be responsible for all watering necessary until Final Acceptance.
- B. All areas of the site shall be watered in a manner to avoid excessive quantities in small areas, erosion or damage to adjacent finished surfaces and in compliance with City of Aurora watering restrictions or permit if applicable. Water shall be applied at low pressure to thoroughly soak the planting site without dislodging the soil.
- C. Sod shall be watered upon completion of convenient work areas until installation is complete and irrigation system is fully operational. Water sod sufficiently to moisten sub-soils at least two inches (2") deep. Upon completion, sod shall be watered by a permanent in-ground automatic irrigation system operated on a routine basis.
- D. Irrigated Seed Areas shall be watered upon completion of convenient work areas until installation is complete and irrigation system is fully operational. Water the seeded areas to provide adequate moisture for germination, keep the surface moist during germination and to support grass until fully established. Upon completion, seed shall be watered by a permanent in-ground automatic irrigation system operated on a routine basis. Watering shall comply with City of Aurora water use restrictions.
- E. Non-irrigated seeded areas may be watered by an irrigation system or other means as determined by the Contractor and approved by the Project Manager. Temporary, above-ground irrigation must be removed by the Contractor upon Final Acceptance and, if possible, recycled.

3.11 Inspections & Acceptance for Sodding

- A. See list of Inspections in Landscape Installation Specification 02900. Contractor will submit a maintenance program for City staff at time of **notice to proceed**. See Maintenance Specification 01900 for maintenance program. Suggested program will be reviewed by City staff and may be modified by mutual agreement of City and Contractor prior to acceptance of maintenance responsibility by City. See Project Closeout Specification 01700.
- B. Substantial Completion: Sod work shall be considered substantially complete when all sodded areas meet the following criteria:
 - 1. A minimum of 30 days has passed since installation of sod.
 - 2. Contractor has mowed the sod a minimum of two (2) times.
 - 3. There are no visible gaps between pieces of sod or between sod and walls, walks or other improvements.
 - 4. Sod is green, healthy and free of weeds, insects and disease.
 - 5. Sod covering less than ½ of 1% of the total area is dead or brown, with no patches of brown/dead greater than two (2) square feet in area.
 - 6. Sod is rooted to the soil beneath the sod.
 - 7. Grass blades have been recently mowed and no taller than three inches (3") above grade.
 - 8. Sodded area is free of ruts and depressions not consistent with the grading plans.
 - 9. Sod is not covered with dirt or other materials harmful to its appearance and health.
- C. Final Completion: Sodded areas meeting the following criteria shall be considered complete:
 - 1. A minimum of 30 days has passed since installation of all sod, including repairs/replacement.

2. Sod is green, healthy and free of weeds, insects and disease.
3. Sod is rooted to the soil.
4. Sod covering less than ¼ of 1% of the total area is dead or brown, with no patches of brown/dead greater than one (1) square foot in area.

D. Final Acceptance:

1. A minimum of 30 days has passed since installation of sod, including repairs/replacement.
2. Sod is green, healthy and free of weeds, insects and disease.
3. Sod is rooted to the soil.
4. Sod covering less than ¼ of 1% of the total area is dead or brown, with no patches of brown/dead greater than one (1) square foot in area.

3.12 Inspections & Acceptance for Seeding

A. See list of Inspections in Landscape Installation Specification 02900. Contractor will submit a maintenance program for City staff at time of **notice to proceed**. See Maintenance Specification 01900 for maintenance program. Suggested program will be reviewed by City staff and may be modified by mutual agreement of City and Contractor prior to acceptance of maintenance responsibility by City. See Project Closeout Specification 01700.

B. Definitions:

1. Required Density
 - a. For Irrigated Native Grass areas: 16 native grass plants per square foot.
 - b. For Non-Irrigated Native Grass areas: 8 native grass plants per square foot.
 - c. For turf grass (seeded) areas: 100 turf grass plants per square foot.
2. Bare Ground Area: a contiguous area within which no live grass plants, of the seeded native grass species (not including cover crop species), are visible. A line between two seeded grass plants less than 9" apart terminates any contiguous bare ground area within native grass areas. A line between two seeded grass plants less than 2" apart terminates any contiguous bare ground area within turf grass areas.
3. Noxious Weed: Any species included in list A, B or C on the current Weed List published by the Colorado Weed Management Association.
4. Growing Season: May 1st through October 1st
5. Irrigated native grasses: Native grasses within areas that have a permanent, underground irrigation system. With the approval of the Project Manager, areas designated as non-irrigated native grass areas which the Contractor has provided with temporary irrigation system and/or watering by other means per a written schedule, shall be considered an irrigated native grass area and shall be required to meet the irrigated native grass criteria for each phase of acceptance.

C. Germination Acceptance:

1. Germination acceptance shall occur when grass is clearly visible throughout the project area and shall be based on the following:
 - a. Self-sustaining and healthy stand of grass which is evenly distributed throughout the seeded area.
 - b. Dominant vegetation in the seeded area is the specified grasses. The native grasses in the specified mix are visible in quantities representative of the percentages within the seed mix.
 - c. Maximum size of any one bare ground area and minimum percentage of entire area with required density:
 - i. Irrigated native grasses: 3 square feet; 90%.

- ii. Non-Irrigated native grasses: 9 square feet; 85%.
 - iii. Turf: 2 square feet; 95%.
 - d. Less than 10% of the total seeded area is covered by noxious weeds.
 - e. Clear indication that all drill seed rows have germinated.
 - f. Grading within seeded area is consistent with the drawings and free of ruts, depressions and erosion damage.
2. All bare ground areas greater in size than the following shall be re-seeded according to these specifications and germinated prior to Establishment Acceptance:
 - a. Native Grass areas greater than 2 square feet
 - b. Turf areas greater than ¼ square foot (36 square inches).
 3. Any single area exceeding 5% of the total seeded area which fails to meet the minimum percentages (density) listed above shall be re-seeded according to these specifications and germinated prior to Establishment Acceptance.
 4. Germination Acceptance may be granted prior to or after Substantial Completion depending on the season.
 5. Germination Acceptance shall not be granted between August 1st and March 1st.
 6. Maintenance between Germination Acceptance and Establishment Acceptance is the responsibility of the landscape contractor per Maintenance Specification 01900.

D. Establishment Acceptance:

1. Establishment acceptance shall occur at least sixty (60) days after germination acceptance and shall be based on the following:
 - a. Self-sustaining and healthy stand of grass which is evenly distributed throughout the seeded area.
 - b. Dominant vegetation in the seeded area is the specified grasses. The native grasses in the specified mix are visible in quantities representative of the percentages within the seed mix.
 - c. Maximum size of any one bare ground area and minimum percentage of entire area with required density:
 - i. Irrigated native grasses: 2 square feet; 95%
 - ii. Non-Irrigated native grasses: 4 square feet; 90%
 - iii. Turf: 9 square inches; 99%.
 - d. Less than 5% of the total seeded area is covered by noxious weeds. No noxious weeds on List A are present.
 - e. A weed management program approved by the Project Manager has been in place and been effective.
 - f. Grading within seeded area is consistent with the drawings and free of ruts, depressions and erosion damage.
2. The following shall be re-seeded by the Contractor, at no cost to the City, according to these specifications and will be brought to germination and maintained by the Contractor until they meet the Establishment Acceptance criteria.
 - a. All bare spots exceeding the maximum area listed above
 - b. Any single area exceeding 5% of the total seeded area, which fails to meet the minimum percentage (density) listed above.
3. Establishment acceptance shall be granted at the time of Substantial Completion or later

depending on the season but never before Substantial Completion. **There shall be one warranty period for all seeded areas in one project.**

4. See Maintenance Specification 01900 for all maintenance.
5. Final Completion shall not be awarded until after Establishment Acceptance of seeded areas.

E. Final Acceptance:

1. In addition to requirements stated in Project Closeout Specification 01700, the following requirements shall be met prior to award of Final Acceptance:
 - a. Minimum time:
 - i. Irrigated native grasses: One (1) year from date of Germination Acceptance of initial seeding. All re-seeding, except re-seeding described below in 2., has, after germination, been in place for four (4) months during the growing season.
 - ii. Non-Irrigated native grasses: Ten (10) months within the growing season have passed since the date of Germination Acceptance of initial seeding. All re-seeding, except re-seeding described below in 2., has, after germination, been in place for four (4) months during the growing season.
 - iii. Turf: One (1) year from date of Germination Acceptance of initial seeding. All re-seeding, except re-seeding described below in 2., has, after germination, been in place for three (3) months during the growing season.
 - b. Self-sustaining and healthy stand of grass, which is evenly distributed throughout the seeded area.
 - c. Dominant vegetation in the seeded area is the specified grasses. The native grasses in the specified mix are visible in quantities representative of the percentages within the seed mix.
 - d. Maximum size of any one bare ground area and minimum percentage of entire area with required density:
 - i. Irrigated native grasses: 1 square foot; 95%.
 - ii. Non-Irrigated native grasses: 3 square feet; 90%.
 - iii. Turf: 9 square inches; 99%.
 - e. Less than 1% of the total seeded area is covered by noxious weeds. No noxious weeds from List A are present.
 - f. Grading within seeded area is consistent with the drawings and free of ruts, depressions and erosion damage.
2. Prior to award of Final Acceptance of seeded areas, the following shall be re-seeded by the Contractor, at no cost to the City, according to these specifications and will be brought to germination and maintained by the Contractor until they meet the Germination Acceptance criteria.
 - a. All bare ground areas exceeding the maximum areas listed above
 - b. Any single area exceeding 5% of the total seeded area, which fails to meet the minimum percentage (density) listed above.

3.13 Cleanup, Protection and Repairs

- A. Throughout the entire operation, rocks, clods, trash and other debris shall not be allowed to accumulate, but shall be removed daily. The site shall be kept as tidy as possible at all times. Any soil that has been brought onto the concrete path by work operations shall be removed promptly by sweeping. Upon completion of the seeding, all excess soils, rocks, trash and debris, which have not previously been cleaned up, shall be removed from the site or disposed of as directed by the Project Manager.

PART 4 MEASUREMENT & PAYMENT

4.1 Measurement & Payment

- A. Measurement and payment for seeding after Establishment Acceptance and sodding, shall be on a square foot basis as specified in the contract and shall include all fine grading and full compensation for all furnished labor, material and equipment necessary to complete the work in accordance to the plans and specifications.
- B. At the sole discretion of the City, partial acceptance of portions of the seedbed at any of the inspection points may occur. Area to be accepted will be defined on drawings and in writing. Partial acceptance of any portion of the seedbed does not relieve the Contractor of any subsequent requirements within these specifications for that portion or any other portion of the seedbed.

END OF SECTION

CRUSHER FINES PAVING
02510

PART 1	GENERAL	1
1.1	Description of Work.....	1
1.2	Submittals.....	1
1.3	Delivery, Storage, and Handling	1
1.4	Product Conditions	1
PART 2	PRODUCTS.....	2
2.1	Crusher Fines Screenings	2
2.2	Stabilizer	2
2.3	Geotextile Fabric.....	2
PART 3	EXECUTION.....	3
3.1	Vegetative Removal.....	3
3.2	Subgrade Preparation	3
3.3	Geotextile Fabric (if indicated on plans)	3
3.4	Stabilizing Crusher Fines.....	3
3.5	Placing Crusher Fines.....	4
3.6	Backfilling.....	4
3.7	Compaction	4
3.8	Finishing.....	4
3.9	Inspection	4
PART 4	MEASUREMENT AND PAYMENT	5
4.1	Measurement.....	5
4.2	Payment.....	5

CRUSHER FINES PAVING
02510

PART 1 GENERAL

1.1 Description of Work

- A. The work of this section consists of constructing crushed aggregate pavement.
- B. **Related Work:** Sitework Specification 02000; Demolition and Site Preparation Specification 02050; Water Control Specification 02140; Earthwork Specification 02200; Trenching, Backfilling, and Compaction Specification 02220.

1.2 Submittals

- A. Submit one (1) electronic copy of each of the following items to the City of Aurora Project Manager:
 - 1. Crushed Aggregate Pavement
 - a. Submit sieve analysis of material to ensure it meets grading requirements.
 - b. Submit sample of crushed aggregate screenings for approval, one-half (½) cubic foot.
 - c. Sieve analysis and color of crushed aggregate screenings shall be approved in writing by the City of Aurora Project Manager prior to delivery of any material to the project site.
- B. Prepare a sample finished pavement section of each pavement type. Sample section shall be full width of pavement, with length equal to three (3) times the width. The City of Aurora Project Manager prior to final placement of the entire paving shall approve sample pavement section in writing.

1.3 Delivery, Storage, and Handling

- A. Protect all materials from damage during delivery and moisture. Keep geotextile fabric in a dark and dry location

1.4 Product Conditions

- A. Use lightweight hauling equipment. Exercise care in using equipment, avoiding damage to existing facilities.
- B. Review installation procedures and coordinate aggregate paving work with other work affects.
- C. All hard surface paving, including concrete walks and asphalt paving must be completed prior to installation of aggregate paving.
- D. **Cold Weather:**
 - 1. Do not use frozen materials or materials mixed or coated with ice or frost.

- 2. Do not build on frozen work or wet, saturated or muddy subgrade.
- E. Protect partially or fully completed paving against damage from any traffic when work is in progress, curing, maturing, and settling until substantial completion. Any barricade constructed must still be accessible by emergency and fire equipment during and after installation.
- F. Protect adjacent work and surfaces from damage during porous unit paving installation.

PART 2 PRODUCTS

2.1 Crusher Fines Screenings

- A. Clean, hard, durable particles or fragments of ¼ inch minus select brown/gray crushed granite or basalt. Fines shall be evenly mixed throughout the aggregate. When produced from gravel, fifty percent (50%) by weight, of the material retained on a Number four (4) sieve shall have one fractured face.
- B. The portion retained on the Number four (4) sieve shall have a maximum percentage of wear of fifty (50) at five hundred (500) revolutions as determined by AASHTO T96-77
- C. The portion passing a Number forty (40) sieve shall have a maximum liquid limit of twenty-five (25) and a maximum plasticity index of seven (7), as determined by AASHTO T89-81, respectively.
- D. The crushed aggregate screenings shall be free from clay lumps, vegetable matter, and deleterious material.
- E. **Gradation requirements are as follows:**
 - 1. Percentage of Weight Passing a Square Mesh Sieve
 - 2. AASHTO T11-82 and T27-82

<u>Sieve</u> <u>Designation</u>	<u>Percent</u> <u>Passing</u>	<u>Sieve</u> <u>Designation</u>	<u>Passing</u>
3/8 inch	100	No. 30	40 - 50
No. 4	95 - 100	No. 50	25 - 35
No. 8	75 - 80	No. 100	20 - 25
No. 16	55 - 65	No. 200	5 - 15

2.2 Stabilizer (if indicated on plans or bid form)

- A. Stabilizer shall be one of the following products
 - 1. Product used by Pioneer Materials and pre-mixed into crusher fines prior to delivery
 - 2. PineBind from National Land Management, LLC.
 - 3. Or an approved equal

2.3 Geotextile Fabric

- A. If geotextile fabric is indicated on plans, use Typar #3401 thermally spunbonded polypropylene, non-woven, thin geotextile weed control fabric, 4.0 oz./lineal yard weight

American Excelsior Co., 609 South Front Street, Yakima Washington, 98901, telephone 206-699-1426, contact: Tammy Eastman, or approved equal. Needle punched material is not acceptable.

- B. If geogrid is indicated on plans, use Tensar BX1200 or approved equal per manufacturers recommendations. Confirm project specific detail with Tensar sale representative Joe Kerrigan 303-882-6555 or Nicholas Johnson at the City of Aurora 303-326-8277.

PART 3 EXECUTION

3.1 Vegetative Removal

- A. Systemic herbicide shall be applied, as per manufacturer's instructions, to all weeds and grasses within trail alignment to ensure that they be removed/killed completely before any construction on top of existing trail.

3.2 Subgrade Preparation

- A. Prior to placing any pavement, shape, fill, grade, and compact the subgrade, to ninety-five percent (95%) Standard Proctor Density. Where excavation to the finished grade elevation results in subgrade of unsuitable soil, the City of Aurora Project Manager may designate the unsuitable material to be removed and replaced with approval material. Approved material for backfilling shall be City of Aurora Type 2 aggregate base course, or other material approved by the City of Aurora Project Manager.

3.3 Geotextile Fabric (if indicated on plans)

- A. Install fabric between the compacted subgrade and crushed aggregate screenings across the entire width of trail to receive aggregate in addition to twelve inches (12") past the edges. Overlap ends of rolls a minimum of eighteen inches (18").
- B. Areas on which geotextile fabric is to be placed shall have uniform slope, be reasonably free from mounds and windows, and free of any debris or projections, which could damage the material.
- C. The material shall be loosely laid, not stretched. Adjacent strips shall overlap by a minimum of eighteen inches (18"). The material shall be anchored in place with securing pins at three-foot spacing along, but not closer than two inches (2") from each edge and at other locations to the extent necessary to prevent displacement.
- D. Replace or repair damaged or displaced geotextile fabric before or during placement of crushed recycled concrete to the satisfaction of the City of Aurora Project Manager, without additional cost to the City.
- E. Protect geotextile fabric from sunlight prior to installation. Material shall not be exposed to direct sunlight for more than two weeks.

3.4 Stabilizing Crusher Fines

if crusher fines do not arrive on site with stabilizer incorporated, mix the stabilizer in to the crusher fines on site per manufacturer's recommendations.

3.5 Placing Crusher Fines

Place the crusher fines on prepared subgrade, and rake smooth using a steel fine rake to desired grade and cross section. Place in lifts of four inches (4") maximum thickness. Do not apply deeper than four inches (4") in one lift.

3.6 Backfilling

Backfill excavation to ultimate trail edge with scraper spoils, using backfill to hold edge of crusher fines.

3.7 Compaction

- A. Immediately compact aggregate into smooth, firm surface with self-propelled, vibratory roller of sufficient weight. Maintain proper moisture content per proctor submitted by the Contractor. Rolling shall continue until all material is firmly locked and keyed together. The appearance and surface shall be uniform with all ridges removed. Surface shall not vary more than one-half inch ($\frac{1}{2}$ ") when measured with a ten foot (10') straight edge applied parallel to the centerline. Correct any variation by loosening, reshaping, and re-rolling. When finished, compacted trail shall be a minimum of four inches (4") deep in all locations.
- B. In any areas where there are underground pipes, use extreme caution when compacting trail to protect pipe. Discuss alternative compaction methods with the City of Aurora Project Manager prior to execution for approval if pipe hazard is anticipated.

3.8 Finishing

- A. At completion of surfacing, remove excess spoils from along trail edge and deposit on site as directed by City of Aurora Project Manager.
- B. Rake along all trail edges to ensure finished appearance and positive drainage away from trail and into new drainage structures: alter grade if necessary.
- C. Compact backfill materials at edge of trail to match compaction of existing undisturbed grade.

3.9 Inspection

- A. Finished surface shall be smooth, uniform, and solid. Dried, compacted pavement material shall be firm all the way through with no spongy areas. Loose material shall not be present on the surface initially. After the first year of use, a minor amount of loose material is expected on the surface.
- B. Loose gravel on the surface, or unconsolidated crushed aggregate screenings below the surface, is evidence of improper bonding due to poor mixing or insufficient watering. Test the loose material by wetting, then tamping, and allowing it to dry.
- C. Unconsolidated areas shall be dug out and replaced with new crushed screenings with a high proportion of fines meeting the grading requirements of Section 2.1. Patched areas then shall be wetted thoroughly and rolled smooth. Patching shall be completed prior to any pavement smoothing required.
- D. Significant irregularities shall be smoothed out prior to final acceptance of work. Smoothing shall be accomplished by re-wetting/saturating rough areas thoroughly and rolling with a

heavy roller (1,000 - 1,500 pounds powered walk-behind or small rider). Bouncing-type compactors are not acceptable.

- E. Final thickness of completed pavement shall not vary more than ¼ inch from dimension indicated. Measurements may be taken by means of test holes taken at random in finished trail surface. Correct any variations in the thickness beyond the allowable ¼ inch by repeating the installation.
- F. No edges of geotextile fabric or geogrid shall be exposed.

PART 4 MEASUREMENT AND PAYMENT

4.1 Measurement

- A. Measurement for crusher fines paving shall be measured by the square foot complete in place.
- B. Grading, subgrade preparation and compaction of crusher fines shall not be measured separately but shall be included in the price of the crusher fines paving.

4.2 Payment

- A. Crusher fines paving work (including subgrade preparation and compaction) shall be paid for at the contract unit price as bid in the Proposal. The price bid shall include furnishing all labor, equipment and materials necessary for completing the work in place as specified in the Drawings.

END OF SECTION

POURED-IN-PLACE RESILIENT MATTING
02540

PART 1 GENERAL	1
1.1 Description of Work	1
1.2 Quality Assurance.....	1
1.3 Delivery, Storage & Handling	2
PART 2 PRODUCTS	2
2.1 Resilient Matting Material	2
PART 3 EXECUTION	3
3.1 Resilient Matting Material	3
3.2 Maintenance and Cleanup	5
PART 4 MEASUREMENT AND PAYMENT	5
4.1 Measurement.....	5
4.2 Payment	5

POURED-IN-PLACE RESILIENT MATTING
02540

PART 1 GENERAL

1.1 Description of Work

A. The Contractor shall supply all labor, materials and equipment necessary to furnish and install a synthetic, resilient material of gradated rubber granules and polyurethane binding agents mixed and poured-in-place on site, as required by the drawings and specifications. Resilient matting shall include the following:

1. *Fill in with project specifics*

B. Related Work:

1. Earthwork Specification 02200, for compaction
2. Site Improvements Specification 02800, for play equipment.

1.2 Quality Assurance

A. Submittals:

1. The Contractor shall submit the manufacturer's product data and installation details showing all dimensions, details, accessories and installation instructions.
2. The Contractor shall submit the following test reports to the City of Aurora Project Manager within ten (10) days after the Notice to Proceed.
 - a. Test Reports: A copy of manufacturer's test reports indicating compliance with the latest U.S. Consumer Product Safety Commission's Technical Guidelines for Public Playground Safety with regard to thickness of product beneath various equipment height ranges. IPEMA certification required – 1292-99 impact testing. In order to determine performance and longevity, the following test reports shall be required and tested by a certified laboratory. The tests must certify that each material item has been tested for the following physical properties:

ASTM F-1292, Shock attenuation and HIC

ASTM E-108, Flame Spread

ASTM E-303, Skid Resistance

ASTM D-412, Tensile Strength

ASTM D-6241/86, Tear Resistance

Permeability

Proof that the product has been manufactured for at least 5 years.

Material safety data sheets.

Copy of a list of recommended maintenance procedures.

B. Qualifications/References: The Contractor or subcontractor must have proven successful experience in the construction installation of poured in place resilient matting within the last three (3) years. The Contractor or their subcontractor designated to perform this work, shall be required to submit three (3) references, two (2) of which are in similar climates, for projects, which demonstrate successful experience with similar work. These projects must have been installed for a minimum of one (1) year. The installation must be completed by certified factory installers from the location of the manufacturer.

- C. **Warranty and Guarantee:** The manufacturer shall guarantee all materials to be free from defects in workmanship and materials for a period of ten (10) years. Defects include edge raveling, resistance to mildew, bacterial growth, bubbling, delaminating, peeling, loss of integrity, color fading, shedding, cracking, shrinkage and poor UV stability, temporary yellowing or discoloration. The manufacturer must warrant the product to perform in accordance with specifications and against material breakdowns caused by failure of chemical bond under normal use.

1.3 **Delivery, Storage & Handling**

Deliver, store and handle all resilient matting materials to prevent damage and deterioration. All damage, cuts, tears to bags, etc., resulting from improper handling will be the responsibility of the Contractor, and will be replaced at the Contractor's expense as deemed necessary by the City of Aurora Project Manager. Store and protect as required in cold weather conditions.

If warranty work is required on the surfacing, manufacturer or manufacturer's installer shall provide and maintain a six foot (6') high, temporary chain link fence for protection of work at no cost to the City. The temporary chain link fence shall encompass the entire playground area.

PART 2 PRODUCTS

2.1 **Resilient Matting Material**

- A. New resilient matting material shall be a seamless, poured-in-place, hand-troweled application. The surfacing system shall consist of a rubber SBR cushion layer and a top EPDM rubber granule wearing course. All rubber granules shall be bound together with a polyurethane binder. The entire system is poured over a compacted aggregate base course. The thickness of the layers shall be from manufacturers recommendations based on possible fall height.
- B. The following manufacturer's and products have been specified as those which are pre-approved and accepted as equal due to warranty, guarantee and materials required for maximum strength and durability.
3. **"Playbound"** by Surface America, available locally through Rocky Mountain Recreation, Contact Nancy Christy, 303-783-0452.
 4. **"GT Impax"** by Gametime, available locally through Triple M Recreation, Contact Doug Johannsen, 720-489-7311.
 5. **"Tot Turf"** by Robertson Industries, Inc., Contact Kelli Bessell, 602-340-8873
- A. **Materials:**
1. **Polyurethane Primer and Binder:** Elastic polyurethane, Methylene Diphenyl Isocyanate (MDI) based binder with no Toluene Diphenyl Isocyanate (TDI) added. Binder shall contain no solvents, have a low odor and ultraviolet resistant.
 2. **Wearing Course:** Ethylene-Propylene-Diene-Monomere (EPDM) pigmented synthetic rubber granules chipped and gradated to 1-3.5 mm in size. Strand or shredded rubber is not acceptable. Binder for the wearing course only shall be non-ambering and alaphatic.
 3. **Cushion Course:** Styrene-Butadien-Rubber (SBR) processed rubber granules, cellular rubber granules and polyurethane binder. The entire surface system shall be permeable

to water at approximately 0.5 gal/sec.

4. **Colors:** Color of the wearing course shall be selected by the City of Aurora Project Manager. Selection shall be made from the standard available colors. Cushion course shall be all black – no color. Wearing course colors shall be as specified herein. Submit samples as specified. City of Aurora Project Manager has the right to reject the material on the basis of color or color mix inconsistency.

Wearing Course Color: ***Project specific– fill in***

- a. ***Color Mix –1 - (xx% Color, xx% Color, xx% Color)***
 - b. ***Color Mix –2 – (xx% Color, xx% Color, xx% Color)***
 - c. ***Color Mix – 3 (xx% Color, xx% Color, xx% Color)***
 - d. ***Color for Creek – (xx% Color, xx% Color, xx% Color)***
5. Compacted Aggregate Sub-Base:
 - a. Aggregate Selection: Aggregate shall be City of Aurora Type 2 Aggregate Base Course.

PART 3 EXECUTION

3.1 Resilient Matting Material

A. Subbase and Surface Preparation:

1. The entire area is to be cleaned of all trees, stumps, vegetation and topsoil. Prepare the subbase by scarifying existing surface, raking and conforming to a consistent level below top of existing concrete edger, and then roll to a compacted state. The subbase shall be brought to required grades, stable, properly compacted and frost-free. Remove any existing soil, if too high, or fill and compact as needed. When fill is required it shall be placed in six-inch lifts and compacted to a density of ninety-five (95%) proctor. Spray play surface area with water to achieve ninety-five (95%) proctor.
2. See Earthwork Specification 02200 for sub-base compaction requirements.

- B. Slope:** All play areas shall be sloped according to plans. All succeeding construction shall conform to the same slope.

- C. Compacted Aggregate Sub-Base:** The base shall have the specific maximum slope (2%) to one side and shall not vary more than one-eighth inch (1/8") when measured in any direction with a ten-foot (10') straight edge. The base course will not require a cure time, but will be subject to slope intolerance. Density requirement is ninety-five (95%) of standard proctor density with final condition of stone as stable, so as to not shift when traveled on during surface installation process.

D. Cushion Course:

1. Contractor shall install thick cushion course (thickness as required by manufacturer) over the compacted aggregate base. The total thickness shall be recommended per ASTM 1292-99.

2. The Contractor shall adhere to the following installation procedure:
 - a. Determine manageable batch size.
 - b. Thoroughly mix ingredients by mechanical drum mixer to ensure all granules are coated. Rubber granules, binder and mixing additives must be mixed at least two (2) minutes to ensure a complete coating of particles.
 - c. Establish reference points using screed strips to establish proper depth of Poured-in-Place cushion course. The cushion course shall be Poured-in-Place by means of screeding and hand troweled to maintain a seamless application.
 - d. Prior to placement of the cushion course, the Contractor shall prime the vertical edges of all existing concrete to ensure matting does not pull away from edges.
 - e. Allow the cushion course to cure completely before installing the top wearing course surface.

E. Top Wearing Course:

1. The poured cap material shall be composed of EPDM granular rubber and polyurethane resin. The thickness of the poured cap material shall be determined by manufacturer but shall not be less than one-half inch (½") thick. The wearing course shall be screed, troweled, and compacted onto the cushion course. Seams shall be tight with no gaps. Prime the joint surface of existing wearing course material before installing adjacent wearing course. There shall be no seams within areas of a single color which are less than 2500 square feet. All rubber shall remain consistent in gradation and size. Color tinted binder will not be allowed.
2. The wearing course must be compacted manually by using hand trowels and light rollers.
3. Rubber granules, polyurethane binder and mixing additives must be mixed at least two (2) minutes to ensure a complete coating of the particles.

F. Curing Time: Curing time in between the cushion course and top wearing course shall be approximately twelve (12) hours. Curing time before use must be at least forty-eight (48) hours after completion of wearing surface.

G. Weather Limitations: The matting shall not be applied during adverse weather conditions, such as rain, sleet or snowstorms. Based on specific manufacturer's recommendations, resilient matting shall not be installed if temperature is below 50°F. Should any additional cold weather curing ingredients be needed, it shall be at the Contractor's expense.

H. Protection: The Contractor shall be responsible for the protection of the resilient matting during the installation process. The Contractor shall also be responsible for the protection of the surface during curing period following the completion of the installation. It is required that a temporary six-foot (6') high chain link security fence be installed around the perimeter of all the playgrounds from the start of construction through project final acceptance.

1. Any damages to the surfacing during this curing period shall be paid for at the Contractor's expense.

3.2 Maintenance and Cleanup

- A. Upon completion of work, the Contractor shall remove all containers and surplus materials leaving the site in a clean and orderly condition acceptable to the City.
- B. Contractor shall provide the City with a certificate of satisfactory workmanship and warranty application to Surfacing Manufacturer.
- C. Contractor shall supply the City with surfacing maintenance guidelines at the completion of the project.
- D. Contractor shall supply the City with two (2) fifty (50) pound bags of the identical color of EPDM granular rubber used for the project and a five (5) gallon pail of resin.

PART 4 MEASUREMENT AND PAYMENT

4.1 Measurement

Measurement for poured-in-place resilient matting work shall be measured by the square foot installed in place. Excavation, grading and compaction of aggregate base course beneath the playground matting shall not be measured separately.

4.2 Payment

Poured-in-place resilient matting work (including the compacted aggregate sub-base) shall be paid for at the contract unit price as bid in the Proposal. The price bid in the Proposal shall include the cost of all test samples. The price bid includes furnishing all labor, equipment and materials necessary for completing the work in place as specified in the Drawings.

END OF SECTION

HYDRO MULCHING
02550

PART 1 GENERAL	1
1.1 Summary.....	1
1.2 Submittals	1
1.3 Quality Assurance.....	1
1.4 Delivery, Storage and Handling	1
1.5 Project/Site Conditions	1
PART 2 PRODUCTS	2
2.1 Materials	2
PART 3 EXECUTION	2
3.1 Examination	2
3.2 Preparation	3
3.3 Mulching.....	3
3.4 Notification of Inspection.....	4
3.5 Cleaning.....	4
3.6 Protection.....	4
PART 4 MEASUREMENT	4
4.1 Measurement and Payment.....	4

HYDRO MULCHING
02550

PART 1 GENERAL

1.1 Summary

A. **Section includes:** Hydro Mulching.

B. **Related Sections:**

1. Site Preparation Specification 02100
2. Seeding Specification 02480
3. Underground Sprinkler System Specification 02810.

1.2 Submittals

A. **Quality Control Submittals:**

1. Certificates: State, Federal and other inspection certificates shall accompany the invoice for materials showing source or origin. Submit to Owner prior to acceptance of material.
2. Manufacturer's specifications for all products, including, but not limited to, hydromulch and organic tackifier.
3. Certification from supplier that laboratory and field testing of product has been accomplished and that material meets all of the requirements, within this specification, for cellulose wood fiber mulch.

1.3 Quality Assurance

Source Quality Control.

1.4 Delivery, Storage and Handling

General: Comply with best management practices for delivery, storage and handling of material.

1.5 Project/Site Conditions

A. **Existing Conditions:**

1. Import and place any fill material required to adjust the fine grade to meet drainage requirements or to match hard surface or existing adjacent undisturbed grades.
2. Vehicular accessibility on site shall be as directed by Project Manager. Repair damage to prepared grounds and surfaces caused by vehicular movement during work under this section to original condition at no additional cost to City of Aurora.

B. **Environmental Requirements:**

1. Do not apply hydro mulch when wind speed exceeds seven (7) miles per hour.

PART 2 PRODUCTS

2.1 Materials

- A. **Mulch:** Hydro mulch shall be Conwed 200 and Tackifier or approved substitute meeting the following requirements:
1. Mechanically defibrated virgin wood cellulose fiber: May not contain any substance or fiber that may inhibit germination or growth of grass seeds and plants.
 2. Dye to appropriate color to allow proper metering of application.
 3. Fibers must have ability to become evenly dispersed and suspended when agitated in water.
 4. When sprayed uniformly on surface of soil, fibers shall form blotter - like ground cover that readily absorbs water and allows infiltration to underlying soil.
 5. Weight specifications shall refer only to air dry weight of fibers with a standard moisture content of ten percent (10%).
 6. Mulch material shall be supplied in containers not weighing over one hundred (100) pounds and showing air dry weight of fibers.
 7. Organic tackifier shall be psillium seed-derived or guar-based tackifiers which mix readily in the hydromulcher without creating lumps or "fish eyes". It may be supplied with hydromulch fibers or be added at a later time.

PART 3 EXECUTION

3.1 Examination

- A. **General:** Verify that existing site conditions are as specified and indicated before beginning work under this section.
1. **Layout:** All seeded areas shall be mulched. Mulch placement shall not extend beyond seeded area by more than five feet (5'). Delineate areas to be mulched using lath and tape for inspection and approval of the Project Manager prior to seeding. Mulch boundaries shall be smooth and uniform (three inch [3"] maximum variation per ten feet [10']).
 2. **Grades:** Verify that grades are as indicated and specified.
- B. **Unsatisfactory Conditions:** Report in writing to the City of Aurora Project Manager.
- C. **Seeding:** Contractor shall not proceed with hydromulching until seeding has be completed and approved by the City of Aurora Project Manager.
- D. Beginning of installation means acceptance of existing conditions by this Contractor.

3.2 **Preparation**

A. **Protection:**

1. Repair all damage to existing landscape (including eroded valley, rivulets and trenches), utilities, walls, pavements and other site improvements resulting from the operations required by this Section, to the satisfaction of the Manager. The Contractor shall pay all expenses associated with repairs, including those requiring contractors designated by the Project Manager.
2. Identify mulched areas requiring protection and erect barriers for proper protection and traffic control.

B. **Erosion control:** Take measures and furnish equipment and labor necessary to control and prevent soil erosion, blowing soil and accumulation of wind deposited materials at the site throughout the duration of work.

3.3 **Mulching**

A. Mulch all areas designated for seed. Do not apply hydromulch until after seed has been raked into the ground.

B. **Hydro Mulching:**

1. **Mixing:** Add cellulose fiber mulch after proportionate quantities of water and other accepted materials have been placed in slurry tank. Mix ingredients to form homogenous slurry.
2. **Spraying:** Apply slurry mulch uniformly over designated seed areas using control of mulch as metering agent. Apply hydromulch at a rate of twenty-five hundred (2500) pounds per acre plus organic tackifier at a rate of one hundred fifty (150) pounds per acre. Upon completion of the application, soil shall not be visible through the hydromulch.
3. Do not apply in presence of free surface water resulting from rain, melting snow or irrigation.

C. **Hydraulic Mulching Equipment:**

1. Pump shall be capable of operation at one hundred (100) gallons a minute and at one hundred (100) P.S.I., unless otherwise directed.
2. Nozzle shall be adaptable to hydraulic mulching requirements.
3. Storage tanks shall have means of calculating volume used or remaining in tank.

D. **Timing:** Mulch designated areas immediately following seed placement. Mulch shall be placed within forty-eight (48) hours following seeding. If seeding is completed in phases, mulch shall be placed following each phase.

E. **Quality Control:** Repair or re-mulch areas improperly mulched or damaged by Contractor's negligence, in manner specified. Mulch removed by circumstances beyond the Contractor's control shall be repaired and re-mulched as ordered by the Project Manager. Compensation

for re-mulch required by circumstances beyond Contractor's control shall be calculated per the Unit Price in the Bid Form.

- F. The Project Manager shall be notified twenty-four (24) hours prior to each mulch application and will determine if coverage is according to specification.

3.4 Notification of Inspection

- A. **Notification:** Give notice requesting inspection by the Project Manager at completion of mulching operation.
- B. **Deficiencies:** If deficiencies exist, the Project Manager shall specify such deficiencies to the Contractor who shall make satisfactory adjustments and will again notify the Project Manager for final inspection.

3.5 Cleaning

Remove material containers and other debris from site. Clean paved and finished surfaces soiled as a result of work under this Section in accordance with directions given to the Project Manager. Clean out drainage inlet structures. Remove any accumulated soil from the surface of adjacent paved areas, newly sodded areas and undisturbed turf areas.

3.6 Protection

Provide and install barriers as required and as directed by the Project Manager to protect mulched areas against damage from pedestrian and vehicular traffic until acceptance by the Project Manager. Contractor is not responsible for malicious destruction of mulch caused by others.

PART 4 MEASUREMENT

4.1 Measurement and Payment

- A. Measurement and payment for hydro mulch shall be on a square foot basis, including all associated work as bid in the contract proposal.
- B. Contract price shall include the cost of furnishing all labor, equipment and materials necessary to complete the work as shown on the plans and called for in the specifications.

END OF SECTION

SITE IMPROVEMENTS
02800

PART 1 GENERAL.....	1
1.1 Description of Work	1
1.2 Quality Assurance.....	1
1.3 Delivery, Storage & Handling	2
1.4 Warranty.....	2
PART 2 PRODUCTS	2
2.1 Play Equipment.....	2
2.2 Toilet	4
2.3 Picnic Shelter.....	5
2.4 Picnic Table	7
2.5 Benches	7
2.6 Steel Trash Receptacle.....	7
2.7 Drinking Fountain.....	7
2.8 Grill.....	8
2.9 Loop Bike Rack.....	8
2.10 Traffic/Parking Sign.....	9
2.11 Skate Board Stoppers.....	9
PART 3 EXECUTION	9
3.1 Play Equipment.....	9
3.3 Picnic Shelter.....	9
3.4 Picnic Table	9
3.5 Benches	9
3.6 Trash Receptacle.....	9
3.7 Drinking Fountain.....	10
3.8 Grill.....	10
3.9 Bike Rack	10
3.10 Skateboard Stoppers	10
3.13 Traffic & Parking Signs.....	10
PART 4 MEASUREMENT & PAYMENT	10
4.1 Measurement & Payment.....	10

SITE IMPROVEMENTS
02800

PART 1 GENERAL

1.1 Description of Work

A. **Work Included:** The Contractor shall supply all labor, materials and equipment necessary to furnish and install all site improvements as required by the Drawings and Specifications. Site Improvements shall include, but are not limited to the following:

1. Metal and plastic multi-event playground equipment.
2. Other playground equipment.
3. Site furnishings (benches, trash receptacles, tables, bicycle racks, etc.).
4. Shelter (Furnish, Offload, Store, Install and Paint).

B. **Related Work:**

1. Earthwork Specification 02200, for subbase preparation and grading.
2. Site Preparation Specification 02100, for clearing and grubbing.
3. Concrete Specification 03000, for footings.
4. Poured-in-Place Resilient Matting Specification 02540, for poured-in-place surfacing.

1.2 Quality Assurance

The Contractor shall install all prefabricated catalog items as per the manufacturer's recommendations. Contractor must be certified to install play equipment.

- A. **Submittals:** The Contractor shall submit a copy of the manufacturer's shop drawings and installation instructions on all prefabricated catalog items to the City of Aurora Project Manager prior to installation. The Contractor shall install the play equipment only as instructed by the manufacturer.
- B. The Contractor shall submit manufacturer's product data and color samples for all prefabricated catalog items, to the City of Aurora Project Manager for approval prior to placing orders.
- C. In order to be considered, any alternate to the specified items must meet all specifications of the specified items, including but not limited to color, materials, and the individual components. In addition, overall design and aesthetics will be considered.
- D. Submit all color samples for any items listed as an "equal" to the City of Aurora Project Manager.
- E. Potential suppliers shall make submittals to the City of Aurora Project Manager at a minimum of five (5) days prior to the bid opening date for "as equal" approvals. See Special Conditions, Item #12.

- F. **Insurance:** Playground Equipment Manufacturer shall carry minimum of one million dollars (\$1,000,000) product liability.

1.3 **Delivery, Storage and Handling**

Deliver, store and handle all site improvements to prevent damage and deterioration. All damage (dents, scratches, cracks, chips, etc.) resulting from improper handling will be the responsibility of the Contractor and will be repaired or replaced at the Contractor's expense as deemed necessary by the City of Aurora Project Manager.

1.4 **Warranty**

The following minimum warranties are required for all playground equipment:

- A. Limited ten (10) year warranty on all steel posts, clamps and decks against structural failure due to natural corrosion, deterioration, or workmanship.
- B. Limited five (5) year warranty for structural failure of plastic or rubber components.
- C. Limited three (3) year warranty for structural failure of all Spring Equipment.
- D. Limited one (1) year warranty for structural failure of moving parts, and any other materials not covered by the above mentioned warranties.
- E. **All other site furnishings:** Warranty all products and workmanship for one year beyond the date of final completion unless manufacturer's warranty is longer.

PART 2 PRODUCTS

2.1 **Play Equipment**

- A. New play equipment shall be modular type play equipment that features round steel 4.5-5" o.d. posts, punched steel decks and slides without any protruding bolts or nubs on sliding surfaces or interior of tunnel slides. All steel surfaces shall be baked polyester powder coated finish. The following manufacturers and products have been specified as those, which will be accepted as equal, due to availability of components, and materials required for maximum durability.
 - 1. Gametime -
Doug Johannsen: Triple M Recreation 720-489-7311
 - 2. Henderson Recreation Equipment – PlaySteel Max
Melissa Sphatt: All Around Recreation 720-270-5879
 - 3. Landscape Structures, Inc - Playbooster
Joseph Cammack: Rocky Mountain Recreation 303-783-1452
 - 4. BCI Burke – Series 2000
Kerry Ermold: Ermold Park and Recreation Products 303-450-9185
Kirby Boos: AtoZ Recreation 303-670-3789
 - 5. Play World System - Playmaker

Erin Starr: Children's Play Structures & Recreation, Inc. 303-791-7626,
800-874-9943

6. Columbia Cascade – Pipeline & Interplay
Mark Lang: Woods Site & Playscapes 303-688-2132

- B. Contractor shall provide all necessary posts, kickplates, fittings, clamps, railings, protective barriers and other fixtures as necessary to complete structure as indicated on the drawings. Contractor shall be responsible for supplying all components necessary for play structure as shown on drawings. Components on drawings shall take priority over materials list as shown.
- C. All play components used must meet the current C.P.S.C. guidelines.

CUSTOMIZE PER PROJECT.

1. **Play Equipment Name**

*Manufacturers: **xx***

*Model Line: **xx***

*Model: **Custom or number:** (Refer to drawing)*

Examples: Canopy roof (2); Trunk climber; Treescape deck with internal climber(2); Wilderslide-spiral; Balustrade; Aecessibility panel; Sky bridge; Trapeze ring package; Access ladder; crow's nest platform with wheel; Wilderslide-over 'n' under; veranda; crunch bar; talk tubes; nature panel; rain wheel panel; turning bar; double seat; transfer platform; stepped platform.

Notes: Example: Tree-scape theme with tree canopy roofs

*Colors: Posts – **examples: brown***

*Roofs –**dark green***

*Slides – **green***

*Decks, rails, rungs, supports and panels –**Beige***

2. **Example: Swings**

*Manufacturer: **Gametime** or approved equal*

*Model Line: **Powerscapes***

(For any approvals for "as equals" – Contractor has to provide a drawing from the manufacturer showing that the swings will fit within the safety zones as shown on the drawings without impacting the safety zones of any other play equipment specified.)

Model No.: Single Post - Two Bay Swing with 2 bucket seats and 2 tot (fully enclosed) seats

Notes: 2 bucket seats and two fully enclosed Tot seats

Color: Posts – Brown

D. Maintenance Manuals:

A project-specific Technical Maintenance Manual shall be included with all equipment. The Manual shall provide information to establish the frequency of inspections, a description of preventive maintenance and repair procedures and plan-specific inspection report forms for each component part shown on the plan. It shall also include copies of the original plans, installation instructions and parts list. Sandpaper, primer and touch-up paints shall be supplied. Primer and paints shall be in colors that match the structures and shall be compatible with the structure's powder coating. The manufacturer shall provide a chemical cleaner of adequate strength to remove paint, ink and other common forms of graffiti from most materials/surfaces on the structure. The manufacturer shall provide wrenches or other

tools needed to adjust or replace special vandal resistant fasteners. Include also a complete parts manual. The manufacturer shall agree in writing to respond to all maintenance requests within 48 hours.

E. Maintenance Training:

The manufacturer shall develop and conduct a training program to allow the City of Aurora maintenance personnel to become knowledgeable with the play equipment. Training should be oriented to optimize use of the equipment and proper maintenance. The training time shall be no less than what is required to sufficiently train operators.

F. General Construction Description:

1. Material: All materials shall be structurally sound and suitable for safe play. All play components used must meet the current C.P.S.C. guidelines. Durability shall be insured on all steel and aluminum parts by the use of time tested coatings such as zinc plating, powder coating, vinyl clad coating, cadmium plate w/Empigard Seal or equal coating.
2. Polyester Powder Coating: All metal components to be powder-coated shall be free of excess weld and spatter. Parts shall then be thoroughly cleaned in a phosphatizing bath and sealed with a non-chrome seal for corrosion resistance, then thoroughly dried. Powder coating shall be electrostatically applied and oven cured at 400° for a period of 20 minutes.
3. Posts: All posts shall be of seamless steel construction. Posts shall have a 4.5" or 5" outside diameter with a .125" min. wall thickness. All posts shall be powdercoated as specified.

2.2 Toilet

Premanufactured Biological Toilet:

The following manufacturers and products are specified as those that will be accepted as equals for the pre-fabricated vault toilet:

Manufacturer: Biological Mediation Systems, Inc., 800-524-1097

Model No.: Outback, cmu w/ split faced accents

Notes: Roof – 26ga. Steel with drip edge, fascia and soffit cover; 24-hour solar system

OR

Precast Concrete Vault Toilet: Single:

City Master COA-TLT1, 132077 - Single Vault Toilet

Manufacturer: CXT Incorporated Precast Concrete Products

3808 N. Sullivan Road, Bldg. #7, Spokane WA 99216

Contact: David Rogers 800-696-5766; Fax: 509-928-8270

Model No.: Gunnison, Building No. G-1468, without front entry windscreen

Walls: Split face block textured concrete

Roof – ribbed metal texture roof. 4:1 Roof pitch Blue or Leaf Green to match picnic shelter roof

Door Color – bronze (match benches)

Interior Color – factory paint, standard colors

Lighting: Provide interior lighting and exterior light at right side of door as indicated on electrical plans. No exposed conduit allowed.

OR

Precast Concrete Vault Toilet: Double

Manufacturer: CXT Incorporated Precast Concrete Products
3808 N. Sullivan Road, Bldg. #7, Spokane WA 99216

Contact: David Rogers 800-696-5766; Fax: 509-928-8270

Model No.: Tioga, Building xxxx, without front entry windscreen

Walls: Split face block textured concrete

Roof – ribbed metal texture roof. 4:1 Roof pitch; blue or leaf green to match picnic shelter roof

Door Color – bronze (match benches) Powder Coat??

Interior Color – factory paint, standard colors

Lighting: Provide interior lighting and exterior light centered between doors as indicated on electrical plans. No exposed conduit allowed.

Contractor shall include State of Colorado Structural Engineering calculations and drawings for review and approval by City of Aurora Building Permits Division, two (2) sets of Colorado stamped engineering drawings and shall submit shop drawings to project manager for review 30 days prior to installation.

2.3 Picnic Shelter

16' Octagon Charleston Picnic Shelter w/ Steel Collums:

(Contractor to Furnish, Offload, Store, Install and Paint)

Model No.: **Custom** 16' Fiji Octagon

Manufacturer: Classic Recreation Systems

Local Representative: Bud Marolt, G.R. Marolt & Associates, 303-762-1090 or 888-762-1090

Contact manufacturer for pricing, plans and installation requirements

Roof Color: Leaf Green (Submit sample)

Frame Color: Powder coated Dark Green (submit sample; match Treescape play equipment roofs)

Column Color: Powder coated Brown (submit sample; match play equipment posts)

Roof Coverage: ±212 square feet

Roof Dimensions, side to side: 16'-0"

Minimum Clearance: 8'-0"

Roof Height @ Peak: ±11'-2"

Hip Roof: 4:12 pitch

- **Column shall be an 8" dia. steel pipe** minimum .250 wall thickness with sub-surface anchor bolt mounting.
- **All beams shall be structural steel tube** sized according to engineering.
- All bolts shall be A-307 or A-325 hard, hidden at all connections.
- Roofing shall be 24 ga. 17" o.c. standing seam steel pre-cut and pre-finished with ribs running with the slope of the roof.
- All trim shall be 24 ga. pre-finished to match roofing.
- Fascia shall be minimum 3"x 3" tube steel with tube steel tension rings @ each Main beam.
- Column and frame shall be hot dip galvanized and powder coated per the standard specifications.
- All material will be packaged for shipping and delivery and shall be stored to prevent any scratches, dents or marks on the powder-coated surface.
- **Contractor to protect and take all precautions during off-loading, storing and installation to prevent any scratches, dents or marks on all powder-coated surfaces.**
- Contractor to touch-up any dents, scratches or marks after installation and as required by the

- project manager, **using touch-up paint, supplied by the manufacturer, that matches exactly with the powder-coating.** Contractor to supply to the City, one (1) full gallon of extra touch-up paint of each paint color and type used along with the color number or formula for each type, that matches exactly with the powder-coating.
- Contractor shall include State of Colorado Structural Engineering calculations and drawings for review and approval by City of Aurora Building Permits Division, two (2) sets of Colorado stamped engineering drawings and shall submit shop drawings to project manager for review 30 days prior to installation.

OR

20' Square Denver Picnic Shelter w/ CMU Columns:
(Contractor to Furnish, Offload, Store, Install and Paint) **Redtail**

Model No.: 20'x20' Denver Model

Manufacturer: Classic Recreation Systems

Local Representative: Bud Marolt, G.R. Marolt & Associates, 303-762-1090 or 888-762-1090
Contact manufacturer for pricing, plans and installation requirements

Roof Color: Leaf Green (Submit sample)

Frame Color: Powder coated Dark Green (submit sample; match ?????? roofs)

Column Color: standard grey concrete masonry units

Roof Coverage: ±212 square feet

Roof Dimensions, side to side: 20'-0"

Minimum Clearance: 8'-0"

Roof Height @ Peak: ±11'-2"

Hip Roof: 4:12 pitch

- **Column shall be constructed of 8"x8"x16" concrete masonry units.**
- **All beams shall be structural steel tube sized according to engineering.**
- All bolts shall be A-307 or A-325 hard, hidden at all connections.
- **Roofing shall be 24 ga. 17" o.c. standing seam steel pre-cut and pre-finished with ribs running with the slope of the roof.**
- All trim shall be 24 ga. pre-finished to match roofing.
- Fascia shall be minimum 3"x 3" tube steel with tube steel tension rings @ each Main beam.
- Column and frame shall be hot dip galvanized and powder coated per the standard specifications.
- Contractor shall paint any primed or damaged powder coat surfaces.
- All material will be packaged for shipping and delivery and shall be stored to prevent any scratches, dents or marks on the powder-coated surface.
- **Contractor to protect and take all precautions during off-loading, storing and installation to prevent any scratches, dents or marks on all powder-coated surfaces.**
- Contractor to touch-up any dents, scratches or marks after installation and as required by the project manager, **using touch-up paint, supplied by the manufacturer, that matches exactly with the powder-coating.** Contractor to supply to the City, one (1) full gallon of extra touch-up paint of each paint color and type used along with the color number or formula for each type, that matches exactly with the powder-coating.
- Contractor shall include State of Colorado Structural Engineering calculations and drawings for review and approval by City of Aurora Building Permits Division, two (2) sets of Colorado stamped engineering drawings and shall submit shop drawings to project manager for review 30 days prior to installation.

2.4 **Picnic Table**

Square Steel Picnic Table with 3 or 4 Benches:

Manufacturer: Iron Mountain Forge

Model No.: 264-3NN (Pedestal mount; Accessible with three seats)

Model No.: 264-4NN (Pedestal mount; with four seats)

Model No.: 266-6N (6' long table with two benches)

Local Representative: Recreation Plus 303-278-1455

Notes: Seats and tabletops shall be fabricated from 13 gauge, precision punched flat sheet steel. All edges shall be rolled to 2" diameter, to eliminate all sharp corners. For extra rigidity, all table tops and seats shall have 11 gauge steel bracing welded to the underside. The tabletops and seats shall be finished with electrostatically applied dry powder coat color. Seat supports shall be 2-1/2"x 11 gauge square tubing; finished with electrostatically applied dry powder coat color.

Center post shall be 4"x 4 gauge x 48" square tubing with seat support posts electrically welded in place; installed as per manufacturer's detail in a 18" dia. X 28" concrete footing; finished with electrostatically applied dry powder coat color.

Color: Bronze powder coat finish

2.5 **Benches**

For open space areas and along trails:

Manufacturer: Victor Stanley

Local Representative: Adam Benjamin (800) 284-8208

Color: Maple slats and Bronze frame

Model: Model 2 Special, Homestead Series, standard 6' length; 2" x 4"; 2nd Site Systems slats; standard in-ground mount; without armrests.

For park locations:

Manufacturer: Keystone Ridge Designs

Local Representative: Adam Benjamin 800-284-8208

Color: Bronze powder coat finish

Bench with Back - Model No.: RE26 (Reading Bench with back 6')

Bench without Back - Model No.: RE18 (Reading flat bench 8')

2.6 **Steel Trash Receptacle**

Manufacturer: Keystone Ridge Designs

Model No.: C-RE3D-32 (Reading Series) with Bronze powdercoat finish;litter receptacle with door, elevated legs and flat lid; door to open at ground level to allow 30 gallon steel drum to roll in and out on casters; (if in open space area, dome lids are required to keep wildlife out of trash).

Local Representative: Adam Benjamin 800-284-8208

Color: Bronze powder coat finish

*Must have elevated leg for permanent installation.

2.7 **Drinking Fountains**

Drinking Fountain Manufacturer: Haws Corporation 888-640-4297

Model No.: 3380

Color: pick one from nine standard colors – green, silver, red, blue, black, brown, orange, yellow, white

Drainage Well: Flo-Well Storm Water Leaching System

Manufacturer: NDS (800) 726-1994
Model No.: NDS FWAS24 Round Drywell System
Local Representative: RepMasters, Inc. 303-286-7575
Notes: 24" x 28.75" Round Drywell System with NDS FWFF67 Porous Filter Fabric wrap and NDS FWBP24 Flo-Well Bottom

Pedestal Bottle Fillers
Manufacturer: Most Dependable Fountains (MDF)
Model No.: 10100 SMSS
Color: varies

Wall Mount Bottle Fillers
Manufacturer: Most Dependable Fountains (MDF)
Model No.: 10105 WMSS
Color: varies

2.8 Large Group Grill

Manufacturer: Patterson-Williams
Model.: Double grill with 7" x 20" shelf
Model No 1140-10 and 8802-20
Local Representative: Recreation Plus 303-278-1455

2.9 Coal Bin

The following manufacturers and products are specified as those that will be accepted as equals for the coal bins and accessories:

Manufacturer: Pilot Rock
Local Representative: xxxxx
Item: Hot Coal Bin with lid
Model No.: HCB / C black powder-coated

Item: Steel Collection Can
Model No.: CNG-2310C galvanized steel, 31 gallon capacity

Item: Hex Sleeve Anchor
Model No.: BR-4HSA

Manufacturer: BBQGUYS.com
Item: Steve Raichlen cast aluminum charcoal, pellet and ash scoop
ID # 2861892
Model No.: SR8013
Note: provide a length of vandal resistant wire or chain to attach the scoop to the ash bin and allow the scoop to be used to clean out the grill.

2.10 Bike Facilities

Loop Bike Rack:

Manufacturer: DuMor
Model No.: Loop Bike Rack 83 Series; S-2 surface mount
Local Representative: Rocky Mountain Recreation 303-278-1455
Color: bronze powder coat
Mounting: surface mount with orientation, configuration, and dimensions as per Figure 15.2 from

Sec. 146-1508 of the City Code

Bike Repair Station:

Manufacturer: Dero

Model No.

Local Representative: Rocky Mountain Recreation 303-278-1455

Color: varies

Mounting: surface mount with orientation, configuration, and dimensions as indicated

2.10 Traffic/Parking Sign

Traffic signs shall be in the locations indicated on the Drawings. Signs shall meet City of Aurora and MUTC requirements. Signposts will be I-beam posts supplied by Owner.

2.11 Skate Board Stoppers

Manufacturer: Skate Stoppers or approved Equal

Representative: 619-447-6374; www.skatestoppers.com

Model No.: ASLE-R1.0 – Leaf shape with radius to fit on concrete wall edge

ASLE-Flat - Leaf Shape flat to place on top of concrete walls.

FR series (extruded aluminum) – Rectangular with radius to fit on concrete wall edge.

Note: Contractor to check radius of existing concrete walls prior to ordering radius on all skateboard stoppers.

PART 3 EXECUTION

3.1 Play Equipment

The Contractor shall install new play equipment and existing relocated play equipment as per manufacturer's specifications and as per locations shown on the drawings and as directed in the field. Footings shall be laid out and flagged by the Contractor and approved by the City of Aurora Project Manager and adjusted as necessary prior to installation.

3.2 Picnic Shelter

Furnish, Offload, Store, Install and Paint per manufacturer's recommendations and as per the Drawings and specifications.

3.3 Picnic Table

Install accessible steel pedestal mount picnic table with benches as per manufacturer's specifications where shown on Drawings.

3.4 Benches

Install per manufacturer's recommendations in location shown on Drawings.

3.5 Trash Receptacle

Install steel litter receptacle as per manufacturer's specifications where shown on drawings after getting location approval from project manager.

3.6 Drinking Fountain

Install per manufacturer's recommendations in location shown on Drawings.

3.7 Grill, Ash Bin and Accessories

Install per manufacturer's recommendations in location shown on Drawings.

3.8 Bike Rack

Install per manufacturer's recommendations in location shown on Drawings.

3.9 Skateboard Stoppers

Install per manufacturer's recommendations on the concrete wall edges (existing and proposed) in locations as directed by the project manager on-site.

3.10 Traffic & Parking Signs

Install per manufacturer's recommendations in location shown on Drawings.

PART 4 MEASUREMENT AND PAYMENT

4.1 Measurement and Payment

A. Measurement and payment for modular playground equipment and site furnishings shall be at the contract unit price **as bid per each OR as bid per lump sum (choose accordingly)** in the contract. Contract price shall include the cost of furnishing all labor, equipment and materials necessary to complete the work as shown on the Drawings and called for in the specifications.

END OF SECTION

IRRIGATION SYSTEM
02810

PART 1 GENERAL	1
1.1 Description of Work	1
1.2 Related Documents	1
1.3 Quality Assurance.....	1
1.4 Submittals.....	2
1.5 Product Delivery, Storage & Handling	4
1.6 Job Conditions	4
1.7 Irrigation Maintenance.....	4
1.8 Warranty.....	5
PART 2 PRODUCTS	5
2.1 Materials – General.....	5
2.2 Pipe	5
2.3 Sprinkler Heads	6
2.4 Subsurface Drip Irrigation Equipment	6
2.5 Valves & Associated Products	7
2.6 Backflow Enclosures	7
2.7 Controller	8
2.8 Irrigation Control Wire	8
PART 3 EXECUTION	8
3.1 Installation Schedule & Implementation	8
3.2 Inspections	9
3.3 Water Tap & Water Meter	10
3.4 Backflow Preventer	10
3.5 Staking and Layout	10
3.6 Trenching.....	10
3.7 Plastic Pipeline Fittings & Thrust Blocks	11
3.8 Backfilling	12
3.9 Control Wiring.....	13
3.10 Automatic Controller	13
3.11 Valves and Valve Boxes	13
3.12 Sprinkler Heads	14
3.13 Subsurface Drip Systems.....	14
3.14 Flushing and Testing.....	14
3.15 Adjustments.....	15
3.16 Protection and Repairs.....	15
3.17 Clean up	15
3.18 Training	15
3.19 Final Acceptance Inspection	15
PART 4 MEASUREMENT AND PAYMENT	16
4.1 Measurement and Payment	16

IRRIGATION SYSTEM
02810

PART 1 GENERAL

1.1 Description of Work

A. Work shall include all labor, materials and equipment and obtaining of all permits required to construct the sprinkler system as indicated on the irrigation plans and as herein specified. The work shall comply with the requirements of all legally constituted authorities having jurisdiction.

B. Related Work:

1. Landscape Installation Specification 02900,
2. Seeding & Sodding Specification 02480.

1.2 Related Documents

Drawings and General Provisions of the Construction Contract, including General and Special Conditions, apply to the Work of this Section.

1.3 Quality Assurance

A. **Requirements:** Work shall be performed in accordance with the best standards of practice relating to the various trades & under the continuous supervision of a competent foreman capable of interpreting Drawings and Specifications. The Contractor shall notify the Project Manager as soon as any discrepancies between Drawings and Specifications are discovered. Drawings take precedence over specifications.

B. **Coordination:** Coordinate work of this section with site work, plumbing and other trades and schedule in a manner to avoid damage to other work.

C. Explanation of Drawings:

1. It is intended that the Drawings and Specifications specify an efficient and complete sprinkler irrigation system for use in accordance with the Manufacturer's recommendations and meeting the Project Manager's approval without further cost to the City of Aurora.
2. All drawn irrigation components are intentionally oversized for readability. Before beginning any phase of the work, the Contractor shall check and verify field and drawing measurements and shall notify the Project Manager of any discrepancies.
3. The Contractor shall verify the authenticity of all finish grades within the project area for insurance of proper coverage of the sprinkler system. All finish grades shall be approved prior to installation of the irrigation system.
4. All work specified on the Drawings by notes or details shall be furnished and installed whether or not specifically mentioned in the Specifications.
5. Omissions from the Specifications or Drawings, or any miss-descriptions of details or

work, which are absolutely necessary to carry out the intentions of the Drawings and Specifications, shall not relieve the Contractor from performing such omitted details of work.

1.4 **Submittals**

A. **Material List:**

1. All materials shall be new and the best quality of its kind. In addition to compliance with these Specifications and Drawings, all materials and equipment must be accepted by the Project Manager.
2. Submit product literature for each type of pipe and for each item listed in the Irrigation Legend. On the literature, indicate the specific model number and type (i.e. size, color, etc.) by circling item with red pen or highlighting with yellow marker.

B. Proposals for substitute materials may be considered. If the Contractor proposes to use such alternative materials, he/she shall submit a written request for use of the alternate to the Project Manager for his/her review and acceptance seven (7) days prior to bid opening. All sprinkler heads described on the Drawings are designed to provide the coverage shown. If substitutions require re-spacing of the irrigation system, the Contractor shall submit plans showing the layout of the lines to be relocated, size of lines, type and gallonage of sprinklers, for the Project Manager approval.

C. **Record Drawings:**

1. The Contractor shall be furnished, by the Project Manager, with four (4) sets of Specifications and Drawings, which indicate the work which is part of the contract. The Contractor shall record all changes in the work (including exact measurements of buried valves and locations) on one (1) reproducible full-size mylar set, which will become the property of the Project Manager at the time of acceptance. Upon request, the City shall supply the Contractor with an electronic file (AutoCAD) base map for his/her "as-built" drawing.
2. The Contractor shall dimension from two (2) reference points, (sidewalk or road intersection, etc.) the location of the following items:
 - a) Connection to existing water lines.
 - b) Routing of sprinkler main lines (place dimensions a maximum of one hundred feet [100'] apart along routing).
 - c) Control valves for spray zones and drip zones.
 - d) Quick coupling valves.
 - e) Manual drains, stops and waste valves.
 - f) Gate/isolation valves.
 - g) Subsurface drip systems blow-out stubs.
 - h) Control wire routing if not with pressure mainline.

- i) Control wire and communication cable splices.
 - j) Water meters.
 - k) Locations of all sleeving including size, quantity and depth of sleeve.
 - l) Filters.
 - m) Any other equipment as directed by the Project Manager.
3. The Contractor shall deliver, on or before the date of Final Completion, the corrected and complete Drawings to the Project Manager. Delivery of the Record Drawings will not relieve the Contractor of the responsibility of furnishing the Project Manager with required location information during the one (1) year warranty period.
- D. **Backflow Prevention Certification:** Prior to operating the irrigation system, submit a written verification that the backflow prevention valve has been inspected and approved by a certified inspector.
- E. **Operation & Maintenance Manual:** Provide, in a three-ring binder, labeled with the project name and address, information regarding the equipment, warranties and procedures. The Project Manager will determine for each project, which items from the following list will be required.
- 1. Dividers labeled Controller, Valves, Sprinkler Heads, Drip Components, Pipe and Miscellaneous.
 - 2. Manufacturer's information for each product used. Indicate the exact product/model/size used by drawing a red circle around it or by highlighting with a yellow marker.
 - 3. Wiring diagram indicating wire locations and color coding.
 - 4. Type-written Certificate of Warranty from the manufacturer of the heads, valves, subsurface drip equipment and controller.
 - 5. Typewritten letter of Warranty from the irrigation contractor or sub-contractor. Include the name and phone numbers of the appropriate person to contact should repairs or replacements be necessary.
 - 6. Typewritten instructions, explaining in step-by-step format, the spring start up and the winter shut down procedures.
 - 7. Submit written operating instructions, watering schedule, and winterizing operations, spring start-up instructions, irrigation plan reduced to 11" x 17", Irrigation legend (8½" x 11"), and product literature to the Owner prior to final acceptance.
 - 8. Two (2) controller charts indicating zone number, type of sprinkler (rotor, spray, drip or subsurface), location in site, run time necessary to deliver one-quarter inch (¼") of water and gpm of zone. Charts shall be laminated.

1.5 Product Delivery, Storage & Handling

- A. All pipe shall be permanently and continuously marked as follows:
 - 1. Manufacturer's name or trademark, size, schedule, and type of pipe, working pressure at 73°F.
 - 2. National Sanitation Foundation (NSF) approval.
 - 3. Quality control code.
- B. Plastic pipe shall be delivered to the site in unbroken bundles or rolls, package in such a manner as to provide adequate protection for the pipe ends, either threaded or plain.

1.6 Job Conditions

- A. **Site Conditions:** The Contractor shall coordinate his/her work with that of other trades wherever possible so as not to conflict. Before starting work, the Contractor shall inspect the site and check all grades to satisfy him/her that he/she may safely proceed. Changes or alternations in the system to meet site conditions shall be discussed with the Project Manager prior to proceeding with the work.
 - 1. Existing Utilities & Conditions: The Contractor shall at all times and before excavation, take the proper precautions to protect utilities, service lines, cables, conduits, sewers, tanks, and irrigation, the presence of which are known or can be determined by the examination of appropriate plans and maps available through the utility companies or the City of Aurora as well as location of the utilities on site. Contractor shall contact the utility notification center of Colorado at 1-800-922-1987 and have all utilities on site located. If utilities, service lines, cables, conduits, sewers, tanks, or irrigation are to remain in place, provide adequate means of protection during earthwork operations. If these elements conflict with the proposed work the Contractor shall immediately notify the Project Manager. Do not permit heavy equipment such as trucks, rollers or bulldozers to damage these elements. Hand excavate, as required, to minimize the possibility of damage to underground these elements. The Contractor shall be responsible for the cost of repair of any damaged protect utilities, service lines, cables, conduits, sewers, tanks, and irrigation to the satisfaction of the Project Manager and the owner of the property damaged.
 - 2. Water Supply Source: The water supply source shall be as shown on the plans.

1.7 Irrigation Maintenance

Contractor shall maintain all irrigation for a period of time determined by the maintenance warranty. See Warranty Specification 01800. Maintenance shall include, but not be limited to, the following:

- A. Programming the controller for optimum health of landscape and for efficient use of water.
- B. Monitoring the operation of the system.
- C. Repairing or replacing components of the system within twenty-four (24) hours of service interruption.
- D. Communicating with the Project Manager.

- E. After the Certificate of Substantial Completion is issued, the Contractor is responsible for one spring turn on and adjustment (on or about May 1st), and one winterization of the system utilizing compressed air (on or about November 1st). The Contractor shall notify the Project Manager of the exact date of spring start up and fall shut down. All damage due to improper shut down or start up, including damage due to temperatures less than 32 degrees, shall be the sole responsibility of the Contractor.

1.8 **Warranty**

- A. The entire sprinkler system work shall be under Warranty for a period of time consistent with the landscape. See Project Closeout Specification 01700 and Warranty Specification 01800. Should any trouble develop within the time specified above due to faulty workmanship, faulty products or damage by the Contractor, the defect and any resulting damage shall be corrected by the Contractor without expense to the Owner, within twenty-four (24) hours of the notification.
- B. The Contractor is not responsible for sprinkler system repair due to vandalism or due to acts of God. (Also see Warranty Specification 01800.)
- C. Any settling of backfilled trenches, which may occur during the warranty period, shall be repaired without expense to the City of Aurora, including complete restoration of all damaged property.

PART 2 PRODUCTS

2.1 **Materials – General**

All materials shall be new and the best quality of its kind. Unless noted otherwise, the Contractor shall provide all materials. In addition to compliance with these Specifications and Drawings, all materials and equipment must be accepted by the Project Manager. Refer to current Standard Irrigation Equipment List for additional information.

2.2 **Pipe**

A. **General:**

- 1. All pipes shall be continuous, new and permanently marked with the manufacturer's name.
- 2. All pipes shall conform to the United States Department of Commerce commercial standard ASTM D-2241, National Sanitation Foundation No. 14.
- 3. Pipe shall be sized as per Drawings.

B. **Sleeving Pipe:** Pipe shall be Class 200 PVC as manufactured by Eagle Plastics Industries or approved equal. See paragraph E. below for electrical conduit requirements.

C. **Mainline:**

- 1. Two and one-half inch (2-1/2") and smaller: Pipe shall be Class 200 (SDR -21) for

solvent weld joints as manufactured by Eagle Plastics Industries, Inc., or approved equal.

2. Larger than two and one-half inch (2-1/2"): Pipe shall be Gasket Joint PVC Pipe, Class 200 (SDR-21) as manufactured by Eagle Plastics Industries, Inc., or approved equal.
 3. Where pipe crosses under roads or pavement in sleeves and the distance is greater than the available length of rigid PVC pipe, the mainline shall be High Density Polyethylene Pipe (PE 4710 by JM Eagle or approved equal) with a pressure rating of 200 psi. No joints in the mainline are allowed under the pavement.
- D. **Lateral Lines:** All other lateral pipe shall be PVC Class 200 (SDR-21).
- E. **Electrical Conduit:** Electrical conduit shall be gray Schedule 40 PVC conduit. All pipes shall conform to the Underwriters Label UL651 approved standards.
- F. **Fittings and Connections:**
1. For two and one-half inch (2-1/2") diameter and smaller pipe: Except where noted on the plans or details, all solvent weld PVC pipe fittings shall be ASTM D-2241 Schedule 40 PVC. All threaded fittings shall be ASTM D-2241 Schedule 80 PVC.
 2. For pipe larger than two and one-half inch (2-1/2") diameter: All fitting shall be ductile iron, self-restrained fittings.
 3. Triple Swing Joint Fittings: All triple swing joint fittings shall be Rainbird TSJ of size indicated on the plans and details.
 4. Slip fitting socket taper shall be of a certain size so that a dry unsoftened pipe conforming to these specification provisions can be inserted no more than halfway into the socket.
 5. Plastic saddle and flange fittings shall not be permitted.
 6. All threaded pipe shall be Schedule 80 PVC pipe.

2.3 **Sprinkler Heads**

- A. **Pop-up Spray Sprinklers:** Pop-up spray sprinkler heads shall be as listed in the Irrigation Legend on the Drawings. All heads shall be ratcheting with a removable nozzle. All nozzles shall have matched precipitation rates. The nozzle delivery pattern shall be as indicated on the drawings.
- B. **Pop-up Rotor Sprinklers.** Rotary spray sprinkler heads shall be as listed in the Irrigation Legend on the Drawings. All heads shall be ratcheting with a removable nozzle. The nozzle size and delivery pattern shall be as indicated on the drawings.

2.4 **Subsurface Drip Irrigation Equipment**

- A. All products used for subsurface drip irrigation systems shall be manufactured by Netafim USA and shall be as listed in the Irrigation Legend on the drawings. These products shall include, but not be limited to, the following:
 1. Dripline with or without emitters.
 2. Pressure-regulating Filter.

3. Flush Valves.
4. Fittings.
5. Air relief valve
6. Accessories.

2.5 **Valves & Associated Products**

- A. **Backflow Prevention Valve:** The Backflow prevention valve shall be as listed in the Irrigation Legend on the drawings. Sizes shall be as shown on the drawings.
- B. **Electric Remote Control Valve:** The remote control valves shall be as listed in the Irrigation Legend on the drawings. Sizes shall be as shown on the drawings. Provide valve with a pressure regulating device, except drip zone valves.
- C. **Quick Coupling Valves (2-piece body):** The quick coupling valves shall be as listed in the Irrigation Legend on the drawings.
 1. **Quick-Coupling Valve Keys:** The valve keys shall be of the same manufacturer as the quick coupling valves and shall be of proper size to fit the valves listed in the Irrigation Legend. The Contractor shall furnish the Project Manager with two (2) valve keys.
 2. **Swivel Hose Ells:** The swivel hose ells shall be of the same manufacturer as the quick-coupling valves with one-inch (1") standard female pipe thread connection and three-quarter inch ($\frac{3}{4}$ ") male hose thread connection. The Contractor shall furnish the Project Manager with two (2) hose swivels.
- D. **Ball Valve:** The plastic ball valve shall be as indicated in the Irrigation Legend.
- E. **Angle Valve:** The angle valve at the control valve shall be an angle valve connection by Leemco, Inc. or approved equal. Size to match control valve size, unless indicated otherwise on the Drawings.
- F. **Gate/Isolation Valve:** The gate valve/isolation valve shall be a resilient seat gate valve by Leemco, Inc. or approved equal. Isolation valves located on the main line shall have a square nut. Size to match pipe size, unless indicated otherwise on the Drawings.
- G. **Drain Valve:** Drain Valve shall be a bronze curb stop by the Ford Meter Box Company or approved equal. Size per Details and Drawings.
- H. **Stop and Waste Valve:** The stop & waste valve shall be a bronze stop & drain ball valve by Ford Meter Box Company or approved equal. Size to match pipe.
- I. **Valve Boxes:** All valves boxes shall be manufactured by Pentek and shall be the "T" top models. Size and shape shall be as indicated in the Drawings and Details.
- J. **Aggregate:** For drainage sumps and beneath valve boxes, the aggregate shall be washed, free-draining river rock, three-quarter inch ($\frac{3}{4}$ ") to one and one-half inches ($1\frac{1}{2}$ ") in diameter.
- K. **GeotextileFabric:** Geotextile fabric shall be 3.5 oz./sq.yd. Polyspun filter fabric (see Details).

2.6 **Backflow Enclosures**

The backflow enclosures shall be as shown in the Details on the Drawings.

2.7 Controller

A. **USE IF PROJECT IS BEING CONSTRUCTED BY A DEVELOPER FOR A PROPERTY THAT WILL EVENTUALLY BE MAINTAINED BY THE CITY.** The temporary automatic controller shall be supplied and installed by the Contractor. The temporary automatic controller shall be a _____ (typically a Hunter ICC, but will be determined by the PROS Department on a case-by-case basis) with the necessary number of stations. After Final Completion, the controller shall become the property of the City.

USE IF PROJECT IS BEING CONSTRUCTED BY THE CITY. The automatic controller shall be supplied by the Contractor. The automatic controller shall be a _____ (to be determined by the PROS Department on a case-by-case basis) with the necessary number of station.

B. **USE IF PROJECT IS BEING CONSTRUCTED BY A DEVELOPER FOR A PROPERTY THAT WILL EVENTUALLY BE MAINTAINED BY THE CITY.** The permanent automatic controller shall be supplied by the Contractor. The permanent automatic controller shall be a _____ (to be determined on a case-by-case basis by the PROS Department) with the necessary number of stations.

C. The Contractor shall supply and install the controller enclosures, concrete pads, 120V power supply and other components as per the Details on the Drawings.

D. **Rain Sensor:** The rain sensor shall be as indicated in the Irrigation Legend and shall be provided, but not installed, by the Contractor.

2.8 Irrigation Control Wire

Wire shall be Type PE, 14 AWG, single conductor or twisted pair (as shown on plans), insulated wire suitable for direct burial applications. If wire length exceeds 2500 feet, wire shall be 12 AWG. Wire shall be UL listed and have a .045" covering of low density, high molecular weight polyethylene insulation. Wire colors and types shall be as listed in the Wiring Table on the drawings.

PART 3 EXECUTION

3.1 Installation Schedule & Implementation

A. Connections to existing distribution systems or mains in developed areas shall be scheduled so that use of these mains to irrigate other portions of the project will not be interrupted for more than two (2) consecutive days.

B. The schedule of construction shall be set, so that no lawn area or plant material is without irrigation for more than two (2) consecutive days, unless approved, in writing, by the Project Manager or Inspector.

C. The location of each run of pipe, or laterals and all sprinkler heads and valves shall be staked out by the Contractor prior to trenching. Before installation is begun in any given area, the Inspector shall check all locations and give his/her approval or disapproval. All pipe, valves, fittings, etc., shall be carefully placed in the trenches with concrete thrust blocks to be poured at all fittings and valves, as indicated on the Details. The interior of pipes shall be kept free from dirt and debris and when pipe laying is not in progress, open ends of pipes shall be

closed by approved means.

3.2 **Inspections**

- A. The Contractor shall arrange a meeting with the Project Manager or Inspector, prior to commencing work, at which time the Contractor shall be informed of the specific instructions required and the method of calling for such inspections as the individual work is completed.
- B. When the Contractor is prepared for one of the required inspections, he/she shall give the Project Manager notice to visit the site and perform the inspection. This does not preclude the right of the Project Manager to make informal inspections at any time during the work of this section.
- C. The required irrigation inspections for which the Contractor must notify the Project Manager twenty-four (24) hours in advance are as follows:
 - 1. Sprinkler Location & Piping Layout: After final grading has been approved, the Project Manager shall inspect the staked locations of all sprinkler piping and heads for conformance to the Drawings & Specifications. The Project Manager reserves the right to move, shift or adjust any or all of the stakes to better achieve the design intentions as shown on the Drawings. No trenching shall be done until approval of inspection is complete. No partial acceptance shall be made.
 - 2. Valve Box: After the installation of the first valve is completed, the Project Manager shall inspect for proper installation per details and specifications.
 - 3. Coverage Test: After the sprinkler heads have been installed and backfilling operations are complete, the Contractor, in the presence of the Project Manager or Inspector, shall perform a coverage test to determine if the irrigation system reaches all parts of the lawn and planted areas.
 - 4. Mainline Pressure Test: If determined to be appropriate by the Project Manager, the Contractor shall perform a mainline pressure test. In the presence of the Project Manager, the Contractor shall pressurize the system using compressed air for two to four (2-4) hours to determine if there are significant leaks in the pipe or joints.
- D. The required irrigation inspections for which the Contractor does not need to notify the Project Manager twenty-four (24) hours in advance are below. These inspections shall take place on an on-going basis, as construction proceeds.
 - 1. Wiring Inspection: When the wiring has been installed, the Project Manager shall inspect it for conformance to the Drawings & Specifications. Continuity tests shall be required for spare wires that are not connected to valves.
 - 2. Mainline, Lateral Piping and Valve Inspection: As piping and valves are installed, the Project Manager shall inspect for proper materials and installation.
 - 3. Subsurface Drip Systems: Prior to the Contractor covering subsurface drip systems, the Project Manager shall inspect the operation of the system to insure that all emitters are operating properly.
- E. The Project Manager/Inspector prior to soil preparations, seeding and sodding, must approve operations and installation.

- F. The Contractor shall not cover up or otherwise remove from view any work under this contract without prior approval of the Project Manager. Any work that has been covered prior to inspection shall be uncovered to full view by the Contractor at his/her expense.
- G. If it happens that the Contractor requests inspection of the work and the work is unfinished, the Contractor shall be fully responsible for the inspection costs.

3.3 Water Tap & Water Meter

Water tap and water meter, if required, shall be installed in accordance with City of Aurora requirements, in location indicated on the drawings.

3.4 Backflow Preventer

Backflow preventer shall be provided and installed by the Contractor as per Drawings. The Contractor shall install a pre-fabricated base or concrete slab to which the enclosure will be attached (see Details). The Contractor shall install the backflow enclosure per manufacturer's recommendations. The Contractor shall have the backflow preventer tested by a certified testing agency and present proof of certification to the Project Manager (see Submittals).

3.5 Staking and Layout

- A. The Contractor shall provide all materials necessary for the staking of the proposed irrigation system.
- B. The Contractor shall flag main line location, heads, controller and backflow prevention device for the new system. Once the heads have been flagged, the Contractor shall contact the Project Manager or Inspector twenty-four (24) hours in advance, and request inspection of layout and staking. The Project Manager or Inspector will observe layout and indicate any changes as needed. Observation does not relieve the Contractor of responsibility for acceptable coverage.

3.6 Trenching

- A. Trenching for PVC pipe sprinkler lines shall be straight with bottoms at uniform slopes and of sufficient depth to provide minimum cover above the top of the pipe. Trenches shall be of sufficient width to permit proper handling and installation of pipe and fittings, and to allow a thorough tamping of the backfill material under and around the pipe.
- B. Pipe depths are absolute minimums and it shall be the Contractor's responsibility to determine the exact pipe depths in conjunction with the prescribed cold weather drainage protection. Depth to top of pipe shall be as indicated below. Maximum depth shall be no more than three inches (3") greater than minimum depth unless approved by Project Manager.
 - 1. For lateral lines: eighteen inches (18") minimum depth.
 - 2. For main lines: twenty-eight inches (28") to thirty-two inches (32") depth.
- C. All irrigation lines shall have a minimum horizontal clearance of twelve inches (12") from lines of other trades, except where noted or directed by the Project Manager. The application of

these requirements does not apply to any lines crossing at right angles with each other. A minimum of one-inch (1") vertical clearance shall be maintained between lines, which cross at these angles.

- D. If ground water is encountered during the trenching above the elevation of the bottom of the pipe bell grade, such water shall be removed until the pipe has been installed. The joints and the open ends, if any, shall be plugged to prevent ground water from entering the pipe.
- E. Tunneling shall be permitted only where the pipe must pass under any obstruction, which cannot be removed. In backfilling the tunnel, the final density of the fill must match that of the surrounding soil.
- F. No open trenches or partially backfilled trenches shall be left overnight without suitable warning devices approved by the Project Manager. The site shall be continuously cleaned up of excess and/or waste materials as the backfilling progresses and shall be left in a neat and workmanlike condition to the satisfaction of the Project Manager.
- G. In the event that rocky conditions are encountered, the Project Manager and the Contractor shall agree upon the amount of additional payment. The failure of the Contractor to obtain a written agreement from the Project Manager at the time the rock is encountered, and his/her progressing with any such trenching shall be at his/her own expense. In the event that rocky conditions are made known to the Contractor prior to bidding, then no extra cost shall be allowed.

3.7 Plastic Pipeline Fittings, Thrust Blocks & Restraints

- A. **Installation – General:** All workmanship and materials shall be in conjunction with all applicable local codes and ordinances of legally constituted authorities; where the provisions of these Specifications exceed such requirements, these Specifications shall govern. All plastic pipes shall be installed in accordance with the manufacturer's installation specifications.
- B. **Solvent-weld pipe and fittings:** Solvent-weld plastic pipe shall be cut with a pipe cutter or finetooth hacksaw with the assistance of a square-in sawing device or in a manner to assure a square cut. Burrs at cut ends shall be removed prior to installation, so that a smooth, unobstructed flow will be obtained. Only the solvent recommended by the pipe manufacturer shall be used. The solvent-weld joints shall be made in the following manner:
 - 1. Thoroughly clean the mating pipe & fitting with a clean dry cloth.
 - 2. Apply a uniform coat of primer to the outside of the pipe with a non-synthetic bristle brush. Apply primer to the fitting in a similar manner.
 - 3. Apply a uniform coat of solvent to the outside of the pipe with a non-synthetic bristle brush. Apply solvent to the fitting in a similar manner.
 - 4. Re-apply a light coat of solvent to the pipe and quickly insert it into the fitting.
 - 5. Give the pipe or fitting a quarter ($\frac{1}{4}$) turn to insure even distribution of solvent and make sure the pipe is inserted to the full depth of the fitting socket.
 - 6. Hold in position for fifteen (15) seconds.

7. Wipe off excess solvent that appears at the outer shoulder of the fitting.
 8. Care should be taken so as not to use an excessive amount of solvent, thereby causing a weakening or obstruction on the inside of the pipe.
 9. The joints in the PVC pipe shall be allowed to set at least twenty-four (24) hours before pressure is applied to the system.
- C. **Gasketed Pipe & Fittings:** Dual-seal pipe shall be cut using a tube cutter, fine tooth hacksaw or miter box with assistance of a square-in sawing device or in a manner so as to assure a square cut. The end of the pipe, to make entry to the rubber ring gasket and socket, must be beveled. Round the lead end of the bevel with a file. Wipe any dirt from the surface of the gasket and from groove. The gasketed joints shall be made in the following manner:
1. Lubricate the exposed face of the gasket.
 2. Lubricate spigot end of the pipe on the entire beveled circumference and one and one-half inches (1½") behind the pipe end.
 3. Hand align pipe end with bell until it contacts gasket uniformly.
 4. Push with turning motion up to stop mark.
 5. Install pipe restraints at joints where required by Details on Drawings.
- D. **Thrust Blocks:** Thrust blocks shall be used at tees and bends beneath backflow preventers and where shown on Drawings. Install per Details on Drawings.
1. The thrust blocks shall be concrete, placed on thoroughly compacted soil.
 2. Minimum thickness of concrete shall be four inches (4") in every dimension.
 3. Thrust blocks shall be allowed to set at least seventy-two (72) hours before pressure is applied to the system.
- E. **Pipe Restraints:**
1. All fittings on pipe that is larger than 2-1/2" diameter shall be self-restrained.
 2. Gasketed pipe joints shall have pipe restraints per the Details on the Drawings. Distance from fittings and size of pipe determine requirements.

3.8 **Backfilling**

- A. In no event shall trenches be completely backfilled until all required tests of the system have been completed and until the Project Manager has approved the line. The Contractor may backfill all portions of the trench except areas over pipe joints. Trenches shall be carefully backfilled with the excavated soil after all dirt clods and rocks larger than two inches (2") in diameter have been either broken up or removed. The backfill shall then be equally distributed on both sides of the pipe in twelve-inch (12") layers and thoroughly compacted.
- B. Puddling or jetting shall be used during backfilling operations. An excess of water shall be

avoided in order to prevent disturbance of the ground around the periphery of the pipe and also to prevent unnecessary pressure on the pipe. When jetting is used, jets shall be of approved quality and sufficient length to reach the bottom of each layer. All costs found necessary for the above procedure shall be borne by the Contractor.

- C. Backfilling of trenches, which lie below pavement areas, shall be thoroughly compacted to ninety-five percent (95%) relative compaction. If in the event of settling, after paving, the Contractor shall repair the paving as per City of Aurora specifications.
- D. Any settling of backfilled trenches, which may occur during the guarantee period shall be repaired without expense to the City of Aurora, including complete restoration of all damaged property.

3.9 Control Wiring

- A. **Control & Common Wire Installation:** All control wires shall be installed beside the mainline (see Details). Wire shall be placed as loose as possible and with as much slack as possible to allow for expansion and contraction of the wire. Where it is necessary to run wire in a separate trench, the wire shall have a minimum cover of two feet (2') and shall have detectable warning tape installed six inches (6") above the wiring. The wires designated for the master valve shall be placed in Class 200 PVC conduit between the controller and the backflow prevention device.
- B. Connecting and splicing of wire at the valve or in the field may be made by using waterproof wire connectors (as designated by the Details).
- C. The Contractor shall isolate field splices in one (1) central location or more if needed. All field splices shall be placed in a standard rectangular valve box set to grade and branded as per Details.

3.10 Automatic Controller

USE IF PROJECT IS BEING CONSTRUCTED BY A DEVELOPER FOR A PROPERTY THAT WILL EVENTUALLY BE MAINTAINED BY THE CITY. The automatic controller shall be installed by the Contractor in accordance with manufacturer's instructions and as per the Drawing and Details. The Contractor shall supply and install the controller enclosures, concrete pads, 120 V power supply and other components as per the Drawings and Details.

USE IF PROJECT IS BEING CONSTRUCTED BY THE CITY. The automatic controller shall be installed by the City in accordance with manufacturer's instructions and as per the Drawing and Details. The Contractor shall supply and install the controller enclosures, base, 120 V power supply and other components as per the Drawings and Details.

3.11 Valves and Valve Boxes

- A. **Control Valves:** Control valves shall be installed in a branded valve box as per Detail.
- B. **Quick Coupling Valves:** Quick Coupling valves shall be installed in a branded valve box with swing joint assemblies as per Detail.
- C. **Valve Boxes:** Control valve boxes shall be installed on a minimum of four inches (4") of aggregate material over geotextile fabric for proper foundation of box and easy leveling of box to proper grade and also to provide drainage of the access box. Aggregate shall extend

three inches (3") beyond the valve box in each direction.

1. All valve access boxes shall be provided with proper length and size extensions, wherever required, to bring the valve boxes level with the finished grade (see Details).
2. All valve box covers shall be branded one-eighth inch (1/8") deep with the letters indicated in the Branding Legend.

D. **Drainage Sump for Drain Valves:** Provide a sump of free-draining aggregate as indicated on the Details.

3.12 Sprinkler Heads

Unless otherwise specifically designated on the Drawings, the installation of sprinkler heads shall include the excavation and backfill, the furnishing, installing and testing of risers, fittings and sprinkler heads, and the removal and/or restoration of existing improvements and all other work in accordance with the Drawings and Specifications.

3.13 Subsurface Drip Systems

Unless otherwise specifically designated on the Drawings, the installation of subsurface drip systems shall include the excavation and backfill, the furnishing, installing and testing of headers, fittings, valves and dripper line, and the removal and/or restoration of existing improvements and all other work in accordance with the Drawings & Specifications. Installation of the subsurface drip system shall be in accordance with the instructions, details and specifications of the Netafim Company, except when indicated differently by the Details in the Drawings.

3.14 Flushing and Testing

- A. After all new sprinkler piping is in place and connected for a given section, and all necessary division work has been completed, prior to the installation of the sprinkler heads, all control valves shall be opened and a full head of water used to flush out the system.
- B. Pressure tests and coverage tests shall be performed as described in section 3.2 of this specification. The Contractor shall provide all equipment necessary for the proper execution of each test.
- C. Wire Testing:
 1. After installation, all wiring attached to equipment shall allow proper operation, be free from damage and meet manufacturer's suggested values. All wiring not attached to equipment shall be free from damage and meet manufacturer's suggested values.
 2. The Owner reserves the right to test all wiring (including required spare wires) for continuity and resistance. It will be sole duty of contractor to find faults and make repairs as needed to bring wiring into compliance with requirements.
 3. City of Aurora Parks, Recreation & Open Space personnel within the Operations and Management Division will conduct all testing and indicate to the Contractor through the Project Manager which wires do not properly operate equipment, exhibit damage and/or do not meet manufacturer's suggested values.

3.15 Adjustments

During the warranty period, the Contractor shall make adjustments to the system as necessary without additional cost to the owner.

3.16 Protection and Repairs

A. Protection of Property:

1. It shall be the responsibility of the Contractor to protect and preserve all utilities, plant materials, structure, etc., from damage during irrigation construction. If damage does occur, all damage shall be completely repaired or restored by the Contractor at his/her own expense, to the satisfaction of the Project Manager.
2. Any unnecessary damage beyond the limits of excavation, or normal working areas shall be repaired and paid for by the Contractor. No trench with the exception at taps, tees, crosses, and meter locations shall exceed twenty inches (20") in width for mainline distribution system, twelve inches (12") in width for rotary head laterals and eight inches (8") in width for all other laterals.

B. Replacement of Paving & Curbs: Damage cause by trenching, crossing existing and/or proposed roadways, paths, curbing, etc., shall be kept to a minimum, and all damaged areas shall be restored to original condition, at the Contractor's expense. This will include compaction of subgrade to ninety-five percent (95%) relative compaction. The Contractor will be responsible for all settling of backfilled trenches for a period of one (1) year, as indicated in section 1.8 of this specification.

3.17 Clean up

Perform clean up as a continuous operation throughout the duration of the work.

3.18 Training

For equipment and systems, such as pump stations, that are more complex or different from typical irrigation systems, the Contractor shall provide the training necessary to familiarize City of Aurora staff with operation and maintenance procedures. The Contractor shall notify the Project Manager to arrange a training session seven (7) days in advance of proposed session date.

3.19 Final Acceptance Inspection

A. At the end of the warranty period, when the Contractor is satisfied that the system is operating properly, that it is balanced and adjusted, and that all work and clean up is completed, he shall notify the Project Manager that he is prepared for Final Acceptance Inspection with date and time at least seventy-two (72) hours in advance. At the given time, the irrigation system shall be inspected by the Project Manager for the following:

1. Sprinkler Heads:
 - a) Heads adjusted to grade.
 - b) Heads properly aligned.
 - c) Nozzles properly adjusted.
 - d) Broken heads replaced.
 - e) Missing heads replaced (stolen or otherwise).

- f) Broken riser replaced.
- 2. Subsurface Drip equipment: Control valves and flush valves operate properly and not leaking.
- 3. Control valves operating properly and not leaking.
- 4. Gate valves and drain valves operating properly and not leaking.
- 5. Controller operating properly and programmed.
- B. Any deficiencies in the system shall be noted by the City of Aurora Project Manager and a written copy shall be given to the Contractor. Within seven (7) days, the Contractor shall make required corrections to bring all materials and work into conformance with the Drawings and Specifications.
- C. Contractor shall provide a revised set of "As-Built" drawings if any modifications have been made during the warranty period that are not correctly reflected on the "As-Built" drawings presented at time of Final Completion.

PART 4 MEASUREMENT AND PAYMENT

4.1 Measurement and Payment

- A. Measurement of the irrigation system shall be on the basis of the entire system furnished and installed complete and in place, including all pipe, fittings, sprinkler heads, valves, wiring, controller enclosures, backflow enclosure and incidentals necessary to complete the item and provide the coverage of the areas to be landscaped.
- B. Payment will be made on the basis of the lump sum bid in the proposal for the irrigation system components and shall constitute full compensation for furnishing all materials, labor, equipment and incidentals necessary to provide a complete system.
- C. Before final payment, the Contractor shall furnish "as-built" of all work by him/her and his/her sub-contractor(s) covered under this contract.

END OF SECTION

THREE RAIL OPEN SPACE FENCE
02832

PART 1 GENERAL	1
1.1 Description of Work	1
1.2 Quality Assurance.....	1
1.3 Delivery, Storage & Handling	1
1.4 Warranty.....	1
PART 2 PRODUCTS	1
2.1 Materials:.....	1
2.2 Fasteners:	2
PART 3 EXECUTION	2
PART 4 MEASUREMENT & PAYMENT	2

THREE RAIL OPEN SPACE FENCING
02832

PART 1 GENERAL

1.1 Description of Work

- A. **Work Included:** The Contractor shall supply all labor, materials & equipment necessary to furnish and install all site improvements as required by the Drawings & Specifications.
- B. **Related Work:**
 - 1. Earthwork Specification 02200, for subbase preparation and grading.
 - 2. Site Preparation Specification 02100, for clearing and grubbing.
 - 3. Concrete Specification 03000, for footings,

1.2 Quality Assurance

- A. The Contractor shall install all prefabricated catalog items as per the manufacturer's recommendations. Contractor must be certified to install play equipment.
- B. **Submittals:**
 - 1. The Contractor shall submit shop drawings and installation instructions which completely describe all materials.

1.3 Delivery, Storage & Handling

- A. Deliver, store and handle all site improvements to prevent damage and deterioration. All damage (dents, scratches, cracks, chips, etc.) resulting from improper handling will be the responsibility of the Contractor and will be repaired or replaced at the Contractor's expense as deemed necessary by the City Project Manager.

1.4 Warranty

- A. The contractor shall warranty all fencing products and workmanship per the Warranty Specification 01800 or for a period of time concurrent with the manufacturers warranty, which ever is longer.

PART 2 PRODUCTS

2.1 Materials

- A. Concrete shall be standard 4500 lb. mix. (fiber mesh optional).
- B. Posts to be 6" x 6" pressure treated wood posts.
- C. Rails to be 2" x 6" pressure treated lumber.
- D. Fabric to be welded wire mesh, 12.5 gauge, galvanized, 2" x 4" openings.

2.2 Fasteners

- A. All fittings, fasteners and hardware to be galvanized heavy duty.
- B. Staples shall be poultry staples.

2.3 Miscellaneous components

- A. Contractor shall provide and install all rails, posts, caps and ancillary components necessary to complete the fence work as indicated on the Drawings.

PART 2 EXECUTION

- 2.1 The Contractor shall install as per locations shown on the drawings and as directed in the field.
- 2.2 Location of footings shall be laid out and flagged by the Contractor and approved by the Project Manager, and adjusted as necessary prior to installation.

PART 3 MEASUREMENT & PAYMENT

- 3.1 Measurement and payment shall be at the contract unit price as bid per linear foot of fence completed in place.
- 3.2 Contract price shall include the cost of furnishing all labor, equipment and materials necessary to complete the work as shown on the Drawings and called for in the specifications.

END OF SECTION

PLAINS CONSERVATION CENTER FENCE
02833

PART 1 GENERAL..... 1
 1.1 Description of Work 1

PART 2 MATERIALS 1
 2.1 Height..... 1
 2.2 Posts, Rails, Fabric, Fittings..... 1

PART 3 EXECUTION 1
 3.1 Process 1

PART 4 SPECIAL CONSIDERATIONS 2
 4.1 Considerations..... 2
 5.1 Measurement and Payment 3

PLAINS CONSERVATION CENTER FENCE
02833

PART 1 GENERAL

1.1 Description of Work

Work covered by this specification concerns all labor, materials and equipment necessary for installing new fencing posts and metal fabric.

PART 2 MATERIALS

2.1 Height

Height of fence shall be as specified by the drawings.

2.2 Posts, Rails, Fabric, Fittings

- A. All posts to be eight feet long pressure treated wood posts. Line posts to be six inches (6") round. Corner and brace posts to be eight inches (8") round.
- B. Top and bottom rails at corner or change of direction to be 2" x 6" pressure treated lumber. Rails are bolted to eight inch (8") posts with two (2) 3/8" x 6" lag bolts using a five-sixteenths inch (5/16") pilot hole.
- C. Fence fabric to be sixty-inch (60") high, galvanized, welded wire mesh, 12.5 gauge, rectangular (2" wide x 4" high) openings.
- D. All fittings and hardware to be galvanized heavy duty.
- E. Fabric is attached to posts with poultry staples. Fabric is attached to top and bottom tension wire with heavy duty galvanized, 9 gauge, hog rings.
- F. Top tension wire is 1/4" wire rope stretched taught and strung through holes drilled in top of posts. Cross angle bracing at brace posts is two double strands of smooth 12.5 gauge wire. Galvanized horseshoe clamps are to be used to secure ends at brace posts.
- G. Bottom tension wire is 7 gauge, galvanized, spiral wire attached to posts with poultry staples.

PART 3 EXECUTION

3.1 Process

- A. Line posts to be set at no greater than twelve feet (12') o.c. Brace posts to be set no greater than eight feet (8') o.c. Brace posts to have concrete footings, minimum of three feet (3') deep and eighteen inches (18") in diameter. Fill line post holes with soil and compact to density of adjacent soil.
- B. Fence fabric to be tightly stretched. Top of fence will be set at approximately fifty-eight inches (58") above grade, bottom of fabric to be at or slightly below grade. Gaps between the fabric and grade are not acceptable. Fabric will be strung to side opposite the Plains

Conservation Center. Top of fence is to transition gently with grade, abrupt vertical changes in height are to be avoided. Contact Project Manager for direction if abrupt changes appear necessary.

- C. A continuous top tension wire will be installed to keep the fabric tight between posts. This wire shall consist of one-quarter inch (¼") wire rope. The wire rope shall be placed in a hole drilled through the post, four inches (4") down from the top of post. The fabric will be attached to the wire rope with hog rings. A minimum of four (4) heavy duty hog rings shall be evenly spaced between posts. Wire rope is not spliced. Terminate wire rope by wrapping around post and clamping wire rope to itself with two galvanized horseshoe clamps.
- D. A continuous bottom tension wire will be installed to keep the bottom of the fabric in line. This wire shall consist of 7 gauge, galvanized, steel spiral wire attached to posts with poultry staples (minimum of two [2] per post), and shall be attached to the fabric with heavy duty hog rings. A minimum of four (4) heavy duty hog rings shall be evenly spaced between posts. Spiral wire shall be spliced by folding two pieces over one another and twisting each wire around itself a minimum of six (6) rotations.
- E. Corner and change of direction (greater than 45 degrees) bracing consists of five (5) eight-inch (8") diameter posts at eight feet (8') spacing. Attach 2"x 6" pressure treated lumber to posts, six inches (6") from top of posts. Continuous one-quarter inch (¼") wire tension line is in place through posts. Double strand 12.5 gauge wire is strung to form an "X" from top of post to bottom of adjacent post. Posts are notched to keep wire at top and bottom of post. Secure wire at each notch with one staple. Each wire is wrapped around a post and twisted around itself a minimum of six (6) rotations. Place turnbuckle in each portion of the "X". Secure wire to turnbuckle by twisting the wire around itself a minimum of six (6) rotations.
- F. Line bracing shall be located a maximum of five hundred feet (500') apart within straight runs of fence and shall consist of three (3) eight-inch (8") diameter posts at eight feet (8') spacing to form corner or change of direction. 2"x 6" pressure treated lumber is bolted to posts, six inches (6") from top of posts. Continuous one-quarter inch (¼") wire tension line is in place through posts. Double strand 12.5 gauge wire is strung to form an "X" from top of post to bottom of adjacent post. Posts are notched to keep wire at top and bottom of post. Secure wire at each notch with one staple. Each wire is wrapped around a post and twisted around itself a minimum of six (6) rotations. Place turnbuckle in each portion of the "X". Secure wire to turnbuckle by twisting the wire around itself a minimum of six (6) rotations.

PART 4 SPECIAL CONSIDERATIONS

4.1 Considerations

- A. Project is running through a plains ecosystem preserve. All vehicles will remain on the outside, development/housing side of the fence. All access is from the Conservatory development. Existing wire fence may be cut to gain access but must be replaced to secure site at the close of each workday.
- B. All dirt removed to place posts will be raked out and dispersed to minimize damage to the grass in the area.
- C. All work must be completed in an orderly and safe manner. Site is to be clean at the close of each day. Blowing or loose trash is not permitted. All left over materials must be removed from the site as work progresses.

PART 5 MEASUREMENT AND PAYMENT

5.1 Measurement and Payment

- A. Fencing shall be paid for at the contract unit price as bid in the contract.
- B. Contract price shall include the cost of furnishing all labor, equipment and materials necessary to complete the work as shown on the plans and called for in the specifications.

END OF SECTION

POST AND CABLE FENCING
02835

PART ONE – GENERAL

1.01 Description of Work..... 1

PART TWO - MATERIALS

2.01 Line, Corner, Bracing and End Posts..... 2
2.02 Pipe Bollards.....2
2.03 Wire and Cable.....2
2.04 Hardware.....2
2.05 Sign Panels.....2

PART THREE – EXECUTION

3.01 General.....3
3.02 Surveying.....3
3.03 Utility Locates.....3
3.04 Staking and Alignment Adjustments.....3
3.05 Footings and Rock.....3
3.06 Corner Posts.....4
3.07 Line Posts.....4
3.08 End Posts.....4
3.09 Earth Removed From Post Excavations.....4
3.10 Electrical Grounds.....4
3.11 Contractor Staging Area.....4

PART FOUR – MEASUREMENT AND PAYMENT

4.01 Measurement and Payment.....5

POST AND CABLE FENCING
02835

PART 1- GENERAL

1.01 Description of Work

This work consists of all labor, materials and equipment necessary for installing new post and cable fencing, including surveying and utility locates.

PART 2 - MATERIALS

2.01 Line, Corner, Bracing and End Posts

Line, corner and end posts shall be 5" diameter, of Douglas Fir or Southern Yellow Pine wood, sawn to the dimensions shown on the plans. All posts shall be of the same species, shall be peeled, straight, sound, and seasoned with ends sawed off square or as indicated on the plans for joining. All knots shall be trimmed flush with the surface. All posts shall be pressure treated in conformance with the American Wood Preservers Association (AWPA) C-14 standards. Treatment with chromated copper arsenate will not be permitted. Braces shall be of the same size and material as the posts.

2.02 Pipe Bollards

Pipe Bollards shall be 5" diameter schedule 40 steel pipe, filled with concrete. Bollards shall be galvanized after cable loops are welded to pipe. Apply 2" wide strips of yellow reflective tape around pipe in two locations as shown on the plans.

2.03 Wire and Cable

Tension wire for bracing shall be 9 GA galvanized. Cable shall be 7 x 19 3/8" black aircraft cable.

2.04 Hardware

All hardware, including clips, bolts, nuts, washers, eyebolts, thimbles, and turnbuckles shall be heavy duty and galvanized.

2.05 Sign Panels

Sign panels shall be .080" thick aluminum plate with graphics as shown on the plans of reflective material. Colors to be chosen by the Project Manager from Contractor supplied samples.

PART 3 – EXECUTION

3.01 General

Confine all construction activities and operations to the area immediately adjacent to the fence alignment, meaning a maximum of 8' either side of the fence alignment except when the fence is adjacent to City Streets or right of way. The Contractor shall be responsible for satisfactory arrangements for permits as required or access to neighboring lands not owned by the City.

All fence posts shall be installed plumb and fencing aligned in smooth curves or straight tangents, as appropriate and/or as directed by the Project Manager

3.12 **Surveying**

The Contractor shall be responsible for researching, surveying and monumenting the City's property line between Stations I and J, only. Stations I and J are shown on the plans. Surveying shall be by a surveyor licensed in the State of Colorado. *Modify per project conditions/requirements*

3.13 **Utility Locates**

The contractor shall be responsible for locating all underground utilities in the area of the work. The Contractor should be aware that numerous utilities exist along street right of way between Stations A and G, as shown on the plans. *Modify per project conditions/requirements*

3.14 **Staking and Alignment Adjustments**

After utility locates and surveying, the Contractor shall stake the fence alignment according to the plans and as modified by the knowledge gained through locates and surveying, including location of gates, end posts and brace sections. The contractor and the Project Manager shall then confer in the field and make alignment adjustments as appropriate to avoid utility conflicts and make the fencing otherwise functional.

3.15 **Footings and Rock**

Footings shall be in accordance with the plans. Earth filled footings shall be backfilled with earth from the excavation, and firmly compacted in 8" lifts. Concrete footings shall be constructed of regular concrete mix via portable mixer, redi-mix, or hand mixing.

Extend the top of all footings slightly above grade and steel trowel to a smooth finish with a slope to drain away from the post. Center all posts in their footings. Set all posts in concrete seven days in advance of pulling cable to allow concrete footings time to obtain strength. Obtain the Project Manager's permission prior to pulling cable.

Where rock occurs within the required depth to which line posts are to be erected, drill a hole of a diameter slightly larger than the diameter of the post and grout in the posts. When encountering rock where concrete footings are called for on the plans, confer with the Project Manager for direction appropriate to the situation.

3.16 **Corner Posts**

Use corner posts at all angle points indicated on the plans. Place the brace on the side of the corner where the longer run of fence exists.

3.17 **Line Posts**

Erect each post plumb, and horizontally line up all posts between horizontal angle, end points and along curves with no visible variation. Line posts shall be approximately equally spaced between brace sections, corner and/or end posts, with no spacing to exceed 20 ft., centerline of post to centerline of post.

3.18 End Posts

Install End posts where indicated on the plans and in details.

3.19 Earth Removed From Post Excavations

Using hand tools only, widely scatter earth removed from post excavations in the area of and on the park side of the fencing, to the satisfaction of the Project Manager.

3.20 Electrical Grounds

When fencing occurs below a power line, ground the cables with a galvanized or copper coated rod, 8 ft. long and a minimum of 5/8 inch in diameter, driven vertically into the ground until the top is approximately 6 inches below the top of the ground. Braze or otherwise firmly attach a 6 GA solid copper conductor with approved clamps to the rod and to the fence cables. Install the ground rod immediately below the power line.

3.11 Contractor Staging Area

All of the Contractor's vehicles, equipment and materials shall be stored and construction staged _____ *fill in with specifics appropriate for project*. The Contractor shall erect a secure, temporary chain link construction fence around their equipment and storage area for the duration of the project. Overnight or weekend storage of vehicles, equipment or materials of any kind will not be permitted anywhere on the site except for this staging area.

PART FOUR – MEASUREMENT AND PAYMENT

4.01 Measurement and Payment

The total length of post and cable fencing installed and accepted shall be measured and paid for on the basis of linear feet of fencing installed times the unit price quoted in the Contract Proposal.

The price per linear foot quoted on the Contract Proposal shall include the cost of furnishing all labor, equipment and materials necessary to complete the work as shown on the plans and called for in the specifications, including utility locates and surveying.

Any additional gate installations directed by the Project Manager shall be paid for separately at the supplemental unit prices quoted in the Contract Proposal.

END OF SECTION

LANDSCAPE INSTALLATION
02900

PART 1 GENERAL	1
1.1 Description of Work	1
1.2 Quality Assurance.....	1
1.3 Submittals	2
1.4 Product Delivery, Storage & Handling	2
1.5 Job Conditions.....	3
1.6 Right of Rejection	3
1.7 Inspection & Acceptance	4
PART 2 PRODUCTS	5
2.1 Soil Analysis:	5
2.2 Site Topsoil.....	5
2.3 Imported Topsoil.....	5
2.4 Fertilizer	5
2.5 Organic Soil Amendment	6
2.6 Mulch:	6
2.7 Staking Material and Tree Wrap.....	7
2.8 Weed Barrier Fabric.....	7
2.9 Edger	7
2.10 Plant Materials.....	7
2.11 Hydromulch:	9
2.12 Water	9
PART 3 EXECUTION	9
3.1 Topsoil Placement	9
3.2 Finish and Fine Grading.....	10
3.3 Amendments for Soil Preparation.....	10
3.4 Soil Preparation	10
3.5 Trees and Shrub Planting Operations	11
3.6 Weed Barrier Fabric.....	12
3.7 Organic Mulch , Breeze, Gravel Rock & Cobble	12
3.8 Restoration and Cleaning.....	13
3.9 Watering.....	13
PART 4 MEASUREMENT & PAYMENT	13

LANDSCAPE INSTALLATION
02900

PART 1 GENERAL

1.1 Description of Work

A. The extent of landscaping work is shown on the Drawings and includes plant materials, grading, soil preparation, irrigation, fertilizing, and landscape work.

B. Related Work:

1. Warranty Specification 01800.
2. Maintenance Specification 01900.
3. Site Preparation Specification 02100.
4. Earthwork Specification 02200.
5. Seeding and Sodding Specification 02480.
6. Hydro Mulching Specification 02550.
7. Irrigation System for Parks Specification 02810.

1.2 Quality Assurance

A. Reference Standards:

1. U.S. Department of Agriculture Rules & Regulations under Federal Seed Act quality standards for Certified Seed.
2. ANSI Z60-1 requirements for measurements, grading, branching, quality, and the balling and burlapping of plants of the American Association of Nurserymen, Inc.
3. Plant measurements specified in the plant list are minimum acceptable sizes. Measure plants before pruning with branches in normal positions.

B. Quality of Materials:

1. Plant materials shall be available for inspection at their sources and at the site and may be rejected if, in the Project Manager's opinion, they fail to meet specified quality or appearance. Remove rejected material promptly from the site.
2. Plants shall have a habit of growth that is normal for the species. They shall be healthy, vigorous, and free from insect pests, plant diseases and injuries. All plant materials shall be inspected stock conforming to the State and Federal regulations.

1.3 Submittals

- A. **Approval of Submittals:** Do not proceed with ordering, purchase or delivery of materials prior to receipt of approved submittals, substitutions & tests from Project Manager.
1. Required for all items specified herein. Email all product data sheets, cut sheets or test results and deliver two (2) samples of all materials to the Project Manager for review.
 2. Supply with cut sheets and samples a detailed list of materials proposed in this project, including Description, Manufacturer/Supplier, and Model.
 3. Plant tags shall not be submitted but remain attached to the plants until Final Acceptance. After Final Acceptance Contractor shall remove all plant tags.
- B. **Substitutions:**
1. Substitutions shall be made only with the written approval of the Project Manager. Substitutions will not be considered prior to opening of the bids.
 2. Substitution of plant material will be made only on the basis of proof of unavailability.
 3. Deliver, mail or email a written request for substitution to the Project Manager for approval. Do not proceed with purchase or installation of materials prior to receipt of approved substitution from Project Manager. Include with the request proof of unavailability, product data, supplier and any other information that will justify the request.
- C. **Testing:** Contractor shall perform and submit the following tests to the Project Manager prior to proceeding with soil preparation or installation of plant material.
1. Submit soils test results for imported topsoil and on site topsoil (stockpiled or unexcavated). Test results shall include all macro and micronutrients, organic matter, and amendment recommendations from the testing laboratory. Each test sample shall be taken from at least three (3) sample locations, to provide an accurate cross section of the soils. The Project Manager may require additional testing if any significant discrepancy is shown by the tests.
 2. Submit soils test results for Organic Amendment. Test results shall include all macro and micronutrients, salinity, organic matter, and carbon nitrogen ratio.
- D. **Record of Purchases:** Package tags and receipts for all topsoil, soil amendments, fertilizers, mulch, fabric, seed, or sod shall be supplied to the Project Manager prior to installation.

1.4 Product Delivery, Storage & Handling

- A. **Delivery Schedule:** Notify the Project Manager of delivery schedule not less than twenty-four (24) working hours in advance of delivery of each type of material.
- B. **Package Materials:** Deliver fertilizer to the site in unopened, original containers, each bearing the manufacturer's guaranteed analysis. Any fertilizer that becomes caked or otherwise damaged, making it unsuitable for use, will not be accepted.
- C. **Plant Materials:** Containerized plant materials with limbs bound and properly wrapped and prepare them for shipping in accordance with recognized standard practice. Keep root systems moist and protected from adverse conditions due to climate and transportation between the time they are dug and actual planting.

1. Identify each plant with grower's label affixed to the plant. Use durable waterproof labels with water-resistant ink that will remain legible for at least sixty (60) days.
 2. Plants to be transported to the project in open vehicles shall be covered with tarpaulins or other suitable covers securely fastened to the vehicle to prevent injury to the plants. Closed vehicles shall be adequately ventilated to prevent overheating of the plants. Do not remove plants from refrigerated trucks into hot weather without allowing time for plants to adjust to heat.
 3. Plants shall be kept moist, fresh and protected at all times. Such protection shall encompass the entire period during which the plants are in transit, being handled, or are in temporary storage.
 4. Plants shall not remain on the site of the work longer than three (3) days prior to planting. Deliver trees and shrubs after preparation for planting has been completed and plant immediately. If planting is delayed more than six (6) hours after delivery, set trees and shrubs in shade, protect from weather and mechanical damage, and keep roots moist by covering with mulch, burlap or other acceptable means of retaining moisture. Keep all roots moist before, during and after planting. Duration and method of storage are subject to the Project Manager's approval.
- D. **Handling:** Do not drop plants. Do not lift plants by the trunk, stems, or foliage. Handle plants by the ball or the container. Reject balled plants if the ball is broken or the trunk is loose in the ball. Protect plants at all times from drying out or injury. Minor broken and damaged roots shall be pruned before planting. Major damage shall be cause for rejection as determined by the Project Manager.

1.5 Job Conditions

- A. Contractor must examine the sub-grade, verify the elevations, and observe the conditions under which the work is to be performed, and notify the Project Manager of unsatisfactory conditions. Do not proceed with work until unsatisfactory conditions have been corrected in a manner acceptable to the City Project Manager.
- B. **Utilities:** Determine location of underground utilities and perform work in a manner which will avoid possible damage. Do not permit heavy equipment such as trucks, rollers or bulldozers to damage utilities. Hand excavate, as required, to minimize the possibility of damage to underground utilities.
- C. Any damage to underground piping or wiring arising out of work of this section must be corrected and repaired by the Contractor to the satisfaction of the Project Manager.
- D. Damage to Other Improvements: All costs for repair or replacement of any damage to other work done on-site or adjacent properties by installation of plant material shall be borne by the Contractor installing plant material.
- E. Existing grades, paving, vegetation and other improvements damaged during planting shall be restored at the Contractor's expense.
- F. Install trees, shrubs, perennials, sod and seed after final grades are established unless otherwise acceptable to the Project Manager.

1.6 Right of Rejection

- A. The Project Manager reserves the right to reject at any time or place prior to Final Acceptance all plant materials, which in the Project Manager's opinion fail to meet specifications. Inspection of materials is primarily for quality, size and variety, but other requirements are not waived even though visual inspection results in approval. Plants may be inspected where available; however, inspection

at the places of supply shall not preclude the right of rejection at the site or at a later time prior to Final Acceptance. Rejected materials shall be removed from the site within twenty-four (24) hours.

- B. The Contractor shall schedule the inspection and tagging of plants by the Project Manager, at the supplier prior to delivery, to be completed in one visit. Any further inspection required due to plants being unavailable or rejected as not meeting specifications shall be charged to the Contractor at the current hourly rate (plus travel expenses if applicable) for Project Manager's personnel performing the inspection.

1.7 **Inspection & Acceptance**

- A. In addition to informal, unscheduled inspections by city staff, the Landscape Contractor & General Contractor shall meet with the City Project Manager or his or her agent at the following inspection times. The City Construction Supervisor, design consultants, Landscape or Irrigation designer may be invited at the request of the Project Manager. Any material, product or workmanship deemed by the Project Manager to be unacceptable or not in accordance with these Drawings & Specifications shall be corrected immediately.

1. **Pre-construction Conference.**

- 2. **Site Record:** Prior to any site activity, Construction Manager shall record condition of all existing site features.
- 3. **Protection** of utilities, monuments, installations, site drainage, trees and plants to remain prior to any other site activity.
- 4. **Sub-grade:** Drainage, formwork and wall footer review (prior to placing cmu block, concrete or topsoil).
- 5. **Materials:** Prior to use (all mulch, compost and fertilizer immediately upon delivery to the site).
- 6. **Plant selection** prior to installation (all plants at one time, at nursery or site).
- 7. **Tree location Staking** (prior to planting trees).
- 8. **Irrigation main line** installation completion (prior to trench backfill).
- 9. **Finish grade.**
- 10. **Seed bed preparation**, planting, drip, irrigation lateral line &, retaining wall cap (prior to seeding, fabric or mulch installation).
- 11. **Seed & Sod installation**, erosion control blanket and hydro or straw mulching completion. See Seed and Sod Specification 02480.
- 12. **Seed germination** approval. See Seed and Sod Specification 02480.
- 13. **Substantial completion & occupancy** (punch list of unacceptable items will be generated). See Project Closeout Specification 01700.
- 14. **Seed establishment** approval. See Seed and Sod Specification 02480.
- 15. **Final completion:** Punch list review. See Project Closeout Specification 01700.

16. Several **warranty/ maintenance** inspections may be required. See Warranty Specification 01800 and Maintenance Specification 01900.
17. **Final acceptance & end of warranty:** Meet after replacement, pruning & removal of stakes & wires. See Project Closeout 01700. Contact Project Manager ten business days prior to desired meeting time.

PART 2 PRODUCTS

2.1 Soil Analysis:

- A. The soil analysis shall be from a soil testing lab equipped to examine soil for horticultural use and make soil amendment recommendations specific to each horticultural use. Use Colorado Analytical Laboratory, (303-659-2313), or approved equal.
- B. Soil samples shall be taken with a core sampler to a six (6) inch depth. One core sample shall be taken for each representative soil region of approximately ten thousand (10,000) square feet. Core samples shall be broken up in to small particles and mixed to create an average sample for a larger representative region. Specific soil regions shall be tested independently if there is any suspicion of substances that may inhibit the growth of plant material such as high salt concentration along roads or in basins so that this soil may be isolated and not used as top soil.

2.2 Site Topsoil

- A. See Earthwork Specification 02200.
- B. The Project Manager reserves the right to inspect topsoil at its source to determine whether or not it meets the requirements specified and to approve the depth to which it may be stripped.
- C. The Contractor shall supply any additional topsoil needed at no additional cost. See imported topsoil below.

2.3 Imported Topsoil

- A. See Earthwork Specification 02200 for description of Imported Topsoil and storage of soil.
- B. Contractor shall submit a one pound sample of imported topsoil and a current analysis of imported top soil.
- C. The Project Manager reserves the right to inspect topsoil at its source to determine whether or not it meets the requirements specified and to approve the depth to which it may be stripped.
- D. Amended topsoil purchased from a soil vendor and imported may be approved as equal to planter mix but must contain a minimum five percent (5%) organic matter and soil that meets the specification for imported top soil.
- E. Contractor shall submit a one pound sample of amended topsoil and a current analysis of the amended topsoil if imported to the site.

2.4 Fertilizer

- A. General: Fertilizer shall be delivered to the site, mixed as specified, in the original unopened standard size bags showing weight, analysis and name of manufacturer. Containers shall bear the manufacturer's guaranteed statement of analysis or a manufacturer's certificate of compliance

covering analysis. These shall be furnished to the Project Manager. Store fertilizer in a weatherproof place and in such a manner that it shall be kept dry and its effectiveness shall not be impaired.

- B. **Commercial Fertilizer:** Complete fertilizer containing the indicated percentages of available plant nutrients.
- C. **Organic, slow release, low fertility fertilizer:** Biosol Forte (7-2-1) or approved equal

2.5 **Organic Soil Amendment**

- A. **Organic Material:** Organic soil amendment shall be Approved, Certified Class II compost product meeting the requirements of this specification. Compost shall be produced on a site compliant with and in accordance with Colorado Department of Health and Environment (CDPHE) regulations pertaining to Solid Waste Composting, effective September 1, 2000. Vendors supplying compost shall supply written certification of compliance with these regulations including applicable permit numbers and facility classification information.
- B. Compost shall be a totally organic product that has been aerobically and naturally processed without the addition of coarse wood chips, in such a manner as to maintain a consistent temperature of 140 degrees Fahrenheit or greater for a period of time sufficient to create the following characteristics, measured by dry weight.

Organic Matter: 25% - 30%

Carbon / nitrogen ratio -- less than 20:1

Salt Content: 8.0 mmhos/cm maximum

pH Range: 6.0 – 8.0

Less than 1% soil, dirt or sand

Maximum particle size of ½ inch diameter

Free of all harmful (i.e. noxious) weed seeds, pathogens and bacteria

- C. Submit a one-(1) pound sample, verification of source and standard compost test results from an approved soils testing laboratory, 10 days prior to delivery.

2.6 **Mulch**

Submit only samples of mulches to be used as stated in the notes and plans.

- A. **Cedar Mulch:** Double shredded long, thin fibers of bark & wood from Western Red Cedar. Submit sample.
- B. **River Rock:** One and one-half inch (1½”) diameter washed rounded river rock; tan, gray or red; from a local source; submit samples.
- C. **Black Granite:** One and one-half inch to two inch (1½”-2”) diameter angular, black granite rock from a local source; submit samples.
- D. **Local Cobble:** Four to eight inch (4-8”) diameter washed rounded river rock; tan, gray or red; from a local source; submit samples.
- E. **White Cobble:** Four to eight inch (4-8”) diameter washed rounded river rock; white in color; from a local source; submit samples.
- F. **Stabilized Crusher Fines:** see specification section 02510 Crusher Fines Paving.

2.7 Staking Material and Tree Wrap

- A. **Tree Wrap:** Shall be first quality, four-inch (4") wide, bituminous impregnated tape, corrugated or crepe paper, brown in color, specifically manufactured for tree wrapping.
- B. Secure tree wrap with a flexible nylon tape strapping specifically designed for tying plant material. No staples, string, cord, or other non-elastic material will be accepted.
- C. **Stakes:** Shall be six-foot (6') green steel "T" posts 1.33 Certified ASTM-A702 with blade, or thirty-inch (30") steel "T" posts as determined by the notes, detail, or execution section of these specifications. From Hutchinson Western or Equal.
- D. **Fabric Tree Straps:**
 - 1. Trees shall be secured to stakes using minimum two-inch (2") wide non-stretching webbing with grommets for attachment of wire between strap and stake. Strap shall be of sufficient length in relation to tree caliper so that grommets and wire do not touch trunk. (Foresight Industries PS-1, non-stretch tree collar straps, or approved substitution.)
 - 2. Oversized fabric tree straps are required for evergreen trees taller than eight feet (8') and any tree that has a trunk too large for normal sized straps.
- E. **Wire:** Shall be twelve (12) gauge galvanized steel wire. All wire shall be marked with flagging tape.

2.8 Weed Barrier Fabric

- A. Weed barrier fabric shall be Mirafi 140N or approved equal in weight and construction. Submit sample and product data for approval.

2.9 Edger

- A. Edger to be steel unless otherwise noted on the plan.
- B. Steel edger shall be four-inch (4") depth, three-sixteenths inch (3/16") thickness, interlocking steel edge, painted green with a rounded non cut top, staked with metal stakes sufficiently to hold in place; and installed per manufacturer's recommendations. Use Pro Steel or approved equal.

2.10 Plant Materials

- A. **All Plants:** Shall be the species, subspecies or cultivar designated on the drawings. No substitutions will be accepted without prior written approval of the Project Manager. All plants shall meet or exceed the code of the standards currently recommended by the "Colorado Nursery Act" and established by the American Association of Nurserymen as well as the ANSI Z60.1 "American Standard for Nursery Stock" latest version but upgraded to meet the following additional requirements.
 - 1. Unless specifically noted otherwise, all plants shall be of selected specimen quality, exceptionally heavy, symmetrical, tightly knit, so trained or favored in their development and appearance as to be superior in form, number of branches, compactness and symmetry. All plants shall have a normal habit or sound, healthy, vigorous plants with well-developed root system.
 - 2. Plants shall be free of disease, insect pests, eggs or larvae.
 - 3. Plants shall not be pruned before delivery.

4. All plants shall have been grown under climatic conditions similar to those in the locality of the site of the project under construction or have been acclimated to such condition for at least two (2) years.
5. All plants designated balled and burlapped (B&B) must be moved with the root systems as solid units with balls of earth firmly wrapped with burlap pinned tight and secured with twine and a wire basket that has been tightened to the ball. The diameter and depth of the balls of earth must be sufficient to encompass the fibrous root feeding systems necessary for the healthy development of the plant and comply with ANSI Z60.1. No plant shall be accepted when the ball of earth surrounding its roots has been badly cracked or broken preparatory to or during the process of planting. All plants that cannot be planted at once must be heeled-in by setting in the ground and covering the balls with soil or mulch and then watering. Burlap and twine made from hemp is preferable to synthetic fibers such as nylon.
6. All trees 2" caliper in size and larger shall be B&B; all trees less than 2" caliper shall be B&B or shall be in plastic Superroots Air-pots.
7. Approximate Minimum ball size for trees are below. Check with American Standard Nursery Stock for exact specifications for each species (ANSI Z60.1).

TREE SIZE	BALL DEPTH MINIMUM	BALL DIAMETER MINIMUM
1 1/2" caliper	16"	20"
2" caliper	18"	22"
2 1/2" caliper	20"	24"
3" caliper	22"	28"

B. Deciduous Shade and Ornamental Trees:

1. Provide B&B trees of sizes listed on the plan. Sizes indicate minimum height or caliper. All deciduous shade and ornamental trees shall have full, well-shaped crowns.
2. Trees with abrasion of the bark, sunscalds, disfiguring knots or fresh cuts of limbs over one inch (1") which have not completely calloused shall be rejected.
3. The trunk of each tree shall be a single trunk growing from a single unutilated crown of roots, unless specified as "clump form".

C. Deciduous Shrubs:

1. Provide shrubs of sizes listed on the plan. Sizes indicate minimum container size, height or spread as labeled. The size in spread shall be used for spreading shrubs and height for more upright types none shall have less than minimum number of canes required by ANSI Z60.1.
2. The thickness of each shrub shall correspond to the trade classification "No.1". Single stemmed or thin plants shall not be accepted. The side branches must be generous, well-twigged, and the plant as a whole well-branched to the ground. The plants must be in moist condition, free from dead wood, bruises or other root or branch injuries.

D. Evergreen Shrubs:

1. Provide shrubs of sizes listed on the plan. Sizes indicate minimum container size, height or

spread as labeled. The size in spread shall be used for spreading and semi-spreading type and height for other types, such as globe, dwarf, and cone, pyramidal, broad up right, and columnar.

2. The thickness of each shrub shall correspond to the trade classification "No.1". Single stemmed or thin plants shall not be accepted. The side branches must be generous, well-twiggged, and the plant as a whole well-branched to the ground. The plants must be in moist condition, free from dead wood, bruises or other root or branch injuries.

E. Evergreen Trees:

1. Provide evergreen trees of sizes listed on the plan. Sizes indicate minimum height. All evergreen trees shall be unsheared and full to the ground.
2. Provide balled and burlapped (B&B) or mechanical, spade-dug evergreen trees.

2.11 Pre-Emergent Herbicide (if required by plans)

Shall be "Treflan" as manufactured by Elanco Company or approved substitution. Apply as per manufacturer's recommendations for weed control.

2.12 Hydromulch

See Hydro Mulching Specification 02550.

2.13 Water & Watering Accessories

- A. The Owner shall provide on-site water for the execution and maintenance of landscape & irrigation to the Contractor at no expense except water used for winter watering. Water for winter watering shall be provided by and paid for by the Contractor.
- B. The Contractor shall furnish all equipment necessary to distribute water from the source provided by the owner including but not limited to all pumps, valves, connections, nozzles, pipes, hose, irrigation equipment and portable tanks & vehicles necessary.
- C. The Contractor shall comply with City of Aurora water use restrictions. Do not exceed PROS water allocation.
- D. Self-watering container for trees: If indicated on plans or proposed by contractor, self-watering containers shall be Leonard ArborRain Tower Tree and Plant Hydrators.

PART 3 EXECUTION

3.1 Topsoil Placement

- A. **Work Included:** Place topsoil in sod or seed areas and to a minimum depth of six inches (6") and in shrub beds or planters to a minimum depth of twelve inches (12"), unless noted otherwise on the plan or specified otherwise here within.
- B. **Area:** All exterior ground within the limit of contract, except surfaces occupied by buildings and structures, paving, and except areas indicated to be undisturbed, shall have topsoil added.
- C. **Preparation:** Rototill, disk, drag, harrow or hand rake sub-grade to a minimum depth of three inches (3") to provide bond for topsoil.

- D. **Placement of Topsoil: Place no topsoil until sub-grade has been approved.** Before placing topsoil, rake subsoil surface clear of stones, debris, and roots. Roughen the bottom and sides of the planting pit. Compact topsoil to form a layer with **minimum depth as defined in the notes**. Topsoil shall be placed so that after final settlement there will be positive drainage and the surface will conform to the elevations shown on the drawings. Contractor is to maintain surfaces and place any additional topsoil necessary per Maintenance Specification.
- E. Topsoil, which must be transported across finished walks, irrigation equipment, utilities or other improvements shall be delivered in such a manner that no damage will be done to the improvements. The Contractor shall be responsible for the repair of such damage.

3.2 **Finish and Fine Grading**

- A. **Positive Surface Drainage:** The Contractor shall finish and fine grade the project area to establish an even and well-matched grade over the entire surface. Positive surface drainage shall be assured, and there shall be no depressions, subsequent settling or irregularities in the finished grade.
- B. **Transitional Areas:** At any transitional point or line where one plane intersects another, such as from a sloping area or berm to a level area, a smooth and gentle transition shall be made. There shall be no abrupt changes in grade which may appear unsightly or may cause mowing operations to damage the grasses, unless specifically noted otherwise. There shall also be a smooth transition between existing turf and new turf.

3.3 **Soil Amendments**

*Note to specification preparer: The schedule of soil amendments for various projects areas are listed below as a benchmark. **The project specific amendment schedule shall be determined by the Project Manager in consultation with the Parks & Forestry Division after review of an analysis of site top soil from a soil testing lab equipped to examine soil for horticultural use. See soil analysis, site topsoil and imported top soil section above.***

- A. **Planting Beds** for Shrubs, Groundcovers and Perennials
 1. Add not less than the following quantities of specified amendment materials to **on-site top soil**:
 - Organic Soil Amendment: 6 cubic yards per 1000 s.f.
 2. Add not less than the following quantities of specified amendment materials to **imported top soil**:
 - Organic Soil Amendment: 5 cubic yards per 1000 s.f.
- B. **Backfill for Trees:**
 - Imported Topsoil: ¼ by volume
 - Sub Soil Excavated From Tree Pit: ¾ by volume

3.4 **Soil Preparation**

- A. After installation of top soil to finished grade elevation, the Contractor shall complete finished grading of all landscaped areas.
- B. **Shrub, Groundcover and Annual/Perennial Beds:** Spread specified amendment materials evenly over bed areas approximately two inches (2") deep and thoroughly incorporate by rototilling or finely disking, to a minimum depth of six inches (6"). If area contains existing trees or shrubs, incorporate amendments by hand raking. The areas shall then be compacted, fine graded and raked to meet the approved finished grade.
- C. **Trees:** Excavate tree planting pit; mix soil amendment thoroughly into excavated soil at the specified

rate.

- D. Restore areas to specified condition if eroded or otherwise disturbed after fine grading and prior to planting.

3.5 **Trees and Shrub Planting Operations**

- A. **Scheduling:** Planting operations shall be performed at a steady rate of work unless weather conditions make it impossible to work. No plant material shall be planted in frozen ground.

- B. **Soil Conditions:**

- 1. If rock or other underground obstruction is encountered, the Project Manager may require plant pits to be relocated, the pits enlarged or the plants deleted from the contract.

(if site has poor drainage overall or in specific areas, consider adding the following:)

- 2. **Plant Pit Drainage:** In random tree/shrub holes (minimum 20%) throughout the site but in particular in plant pits near buildings, fill with water and let stand for twenty-four (24) hours. At the end of twenty-four (24) hours, check hole for drainage of water. Refill the holes and inspect again at twenty-four (24) hours. If the water has not percolated completely into soil, contact Project Manager for additional measures to insure proper drainage.

- C. **Delivery and Storage:** Plants transported to the project in open vehicles shall be covered with tarpaulins or other suitable covers securely fastened to the body of the vehicle to prevent injury to the plants. Closed vehicles shall be adequately ventilated to prevent overheating of the plants. Evidence of inadequate protection following digging, carelessness while in transit, or improper handling or storage shall be cause for rejection. All plants shall be kept moist, fresh, and protected. Such protection shall encompass the entire period during which the plants are in transit, being handled, or are in temporary storage.

- D. **Planting:**

- 1. **Planting Pits:** Holes for balled and burlapped (B&B) trees and shrubs shall be at least two times the diameter of the root ball. Holes for shrubs, perennials, groundcovers and vines in pots shall be at least two times the diameter of the pot.
 - 2. Plants shall be located in the center of the holes. Place root balls on undisturbed soil with a maximum of two inches (2") of loose topsoil in the bottom of the hole to make sure all of the root system is in contact with soil and not air. Top of shrub root crown shall be zero to one inch (0-1") above adjacent finish grade. Top of tree root flare shall be two to three inches (2"-3") higher than adjacent finish grade. Do not use any material to raise trees after they have been placed in the hole unless directed by the Project Manager. See PROS standard details for additional information.
 - 3. **Root System:** B&B plants shall be planted with root ball intact and undamaged. After being placed in the pit, all B&B plant material shall have the entire wire basket removed. Burlap shall be removed from the top two-thirds (2/3) of the root ball. Remove all twine from the root ball and the trunk. If the plant is in a plastic pot, remove the pot after placing the plant in the pit. Root balls that are broken apart after containment is removed shall be considered damaged and shall be rejected. See PROS standard details plans for additional information.
 - 4. **Backfill:** Place specified amended backfill in maximum eight-inch (8") layers and then water each layer to settle the soil before the next layer is placed. Soil shall be lightly tamped under the edges of the plants and place enough soil to maintain finished grade after settling (no mechanical compaction will be allowed).

5. Mulch rings for trees in sod or seeded areas shall comply with requirements of details.
 6. Temporary Watering Saucer: A watering saucer, ring or dam can be provided around each plant, but shall be removed and mulched per details prior to Substantial Completion.
 7. Irrigation: Coordinate with irrigation sub-contractor in order to minimize future disturbance of backfill soil when subsurface drip irrigation is installed around trees.
- E. **Pruning**: Prune trees and shrubs after planting in accordance with good horticultural practice. Prune trees and shrubs to retain required height, spread and natural character (do not cut tree leaders).
1. Remove only damaged or dead branches from shade & ornamental trees.
 2. Remove and replace excessively pruned or misshaped stock resulting from improper pruning.
- F. **Guying/Staking and Wrapping**:
1. Guy and stake trees immediately after planting, as shown on planting details. Eight-foot (8') foot stakes must be used on all shade trees as well as all evergreen & multi leader trees over eight feet (8') tall.
 2. Wrap deciduous tree trunks per planting details between October 1st and November 1st. Before wrapping, notify the Project Manager and request an inspection of tree trunks for injury, improper pruning, and insect infestation. Landscape Contractor shall remove all wrappings between April 15th and May 1st.

3.6 **Weed Barrier Fabric**

The weed barrier fabric shall be placed over the soil in all planting areas mulched with rock or cobble. The mat shall be secured in place by sod pins per manufacturer's recommendations.

3.7 **Organic Mulch, Breeze, Gravel, Rock & Cobble**

- A. Apply materials so that the top of their surface is level with adjacent finished grade as detailed and they are the minimum depth specified after settlement and compaction. Shredded bark mulch, local river & local cobble shall be used unless defined differently in the notes.
- B. Specified shredded bark & cedar mulch shall be spread at a four-inch (4") depth for trees in native grass seed areas; shrubs; spreading groundcovers and perennials, unless defined differently on the plans or in the notes. Mulch shall be placed no closer than 3" from the trunk of trees and up to the base of shrubs, groundcovers and perennials.
- C. Specified gravel or river rock shall be spread at a three-inch (3") depth for drainage ways, shrubs, ornamental grasses & trees in beds unless defined differently on the plan or in the notes.
- D. Specified cobble shall be spread at a minimum eight-inch (8") depth. Hand select and place each cobble close together filling the larger voids with smaller cobble and leaving voids no greater than one inch (1"). Contractor shall prepare a one hundred (100) square feet minimum sample area for review by the Project Manager and the contractor shall make adjustments as may be requested by the Project Manager.

3.8 Restoration and Cleaning

- A. **Restoration and Repair:** Properly repair irrigation system components, underground pipe, electric wiring and other utilities damaged by this work.
- B. **Excess Materials and Debris:** Remove pallets, unused sod, and other debris from the Project site. Clean paved areas over which operations have been conducted.
- C. Empty containers, rocks, clods and other debris shall be removed daily and not allowed to accumulate throughout the entire operation of planting. The site shall be kept as tidy as possible at all times. Any soil, or similar material which has been brought onto paved areas by work operations, shall be removed promptly by sweeping and, if necessary, washing. Upon completion of the planting, all excess soils, rocks and debris which have not previously been cleaned up shall be removed from the site. All ground areas disturbed as a result of planting operations shall be restored to the desired finish grade.

3.9 Watering

- A. The Contractor is responsible for the distribution of water from the source provided by the owner. The contractor shall apply water in a manner consistent with these specifications and deemed appropriate by the Project Manager. The contractor shall be responsible for all watering necessary until final acceptance or full establishment which ever is later. All areas of the site shall be watered in a manner to avoid excessive quantities in small areas, erosion or damage to adjacent finished surfaces and in compliance with City of Aurora watering restrictions or permit if applicable.
- B. Winter Watering: Contractor is responsible for watering during the months between irrigation system shutdown and startup as needed to maintain plants in a healthy condition and to insure plants are alive when irrigation system is turned on and operating correctly.
- C. Trees, Shrubs, Ornamental Grasses, Groundcovers, Perennials and Annuals shall be watered twice within the first twenty-four hours after planting. Water shall be applied at low pressure to thoroughly soak the planting site without dislodging the soil.
- D. The Contractor shall comply with City of Aurora water use restrictions.

PART 4 MEASUREMENT & PAYMENT

4.1 Soil Preparation

- A. For medians, soil preparation shall be paid for at the unit price bid in the contract proposal and include fine grading. One unit shall be a square foot.
- B. For all other sites, soil preparation shall not be paid for separately, but shall be included in the contract price for the related plant material located on the soil.

4.2 Plant material shall be paid for at the unit price bid in the contract proposal. The unit shall be an individual plant and include the excavation, backfill, staking and wrapping necessary to install the plant and, if located in a landscape bed (not in a median) with other plants, shall also include the work necessary to complete that bed. Exclude other bid items such as edging.

4.3 Mulch and Landscape Fabric:

- A. For medians, mulch and landscape fabric shall be paid for at the unit price bid on the contract proposal.
- B. For all other sites, mulch and landscape fabric shall not be paid for separately, but shall be included

in the contract price for the related plant material.

- 4.4** All labor, materials and equipment necessary to complete the work described in the plans and specifications shall be included in the unit or contract price.

END OF SECTION

CONCRETE
03000

PART 1 GENERAL	1
1.1 Description of Work.....	1
1.2 Quality Assurance.....	1
1.3 Submittals	1
1.4 Delivery, Handling and Storage	2
1.5 Job Conditions	2
1.6 Clean Up.....	3
PART 2 PRODUCTS	3
2.1 Concrete Materials.....	3
2.2 Mixes.....	5
2.3 Formwork Materials	5
2.4 Concrete Reinforcing	6
2.5 Joint Materials and Sealants.....	6
2.6 Curing Compound.....	6
PART 3 EXECUTION	7
3.1 Inspection.....	7
3.2 Preparation	7
3.3 Subgrade Preparation.....	7
3.4 Forming.....	8
3.5 Placement of Reinforcement.....	8
3.6 Placing Concrete.....	8
3.7 Curing	9
3.8 Finishing.....	9
3.9 Backfilling.....	10
3.10 Field Quality Control	10
3.11 Repairs and Replacement	13
PART 4 MEASUREMENT AND PAYMENT	14
4.1 Measurement	14
4.2 Payment.....	14

CONCRETE
03000

PART 1 GENERAL

1.1 Description of Work

- A. **Work Included:** The Contractor shall supply all labor, materials and equipment necessary to furnish and install all concrete work specified herein. Concrete work shall include, but not limited to, the following:
1. Concrete walk and flatwork.
 2. Bomanite patterned and colored concrete paving – where indicated.
 3. Bomanite chemical stained concrete – where indicated.
 4. Poured-in-place colored concrete play lots – where indicated.
 5. Raised concrete edge band.
 6. Concrete playground curb edge.
 7. Drilled caissons for picnic shelter.
- B. **Related Work:** Earthwork Specification 02200, for grading.

1.2 Quality Assurance

- A. **Codes and Standards:** Codes and standards conform to current applicable ACI, AASHTO, ASTM and PCA standards. All concrete construction shall conform to City of Aurora Roadway Design Standards and Specifications, latest revision.
- B. **The Contractor:** The Contractor shall be licensed and bonded with the City of Aurora.
- C. **Testing Agency:** See section 3.10, Field Quality Control, for the requirements of testing services and the Contractor's testing responsibilities. All test reports shall bear the seal and signature of a professional engineer, registered in the State of Colorado and competent in the field of concrete testing. Reports not properly certified will not be accepted.
- D. **Report of Work:** A record shall be kept by the Contractor listing the time and date of placement of the concrete.
- E. **Report of Strength:** Report of strength test shall include detailed information on storage and curing of specimen prior to testing, project number and where the concrete was placed. Such record shall be kept until the completion of the project and shall be available to the City of Aurora Project Manager for examination at any time.

1.3 Submittals

- A. **Mix Design:** Project shall use a mix design on the City of Aurora Materials Pre-Approved List (current edition).
- B. **Product Data:** Submit selected mix and source proposed for the work. Submit admixture and

accessory product data.

- C. **Concrete Batch Tickets:** The Contractor shall collect delivery or batch tickets from the ready-mix driver for all concrete used on the project and turn them over to the City of Aurora Project Manager. Batch tickets shall provide weights of fine and coarse aggregates weight (or gallons) of water; including surface water on the aggregates; sack mix content; quantity (cubic yards) of the batch; slump; times of batching and discharging of the concrete; amount of admixture; date and truck number.
- D. **Concrete Test Reports:** Reports of all control tests, special tests or core tests specified under section 3.10, Field Quality Control, shall be distributed by the testing laboratory as follows:
 - 1. One (1) copy -- General Contractor.
 - 2. One (1) copy -- City of Aurora Project Manager.
 - 3. Other copies -- as directed.
- E. **Flatwork Sample:** As a submittal representing an acceptable finish, joints and appearance, the Contractor shall submit the first 30 linear feet of trail installed and the first 30 linear feet of rumble strip. If accepted by the City of Aurora Project Manager, these submittal will establish the finish, joints and appearance required of all trail and rumble strip pavement. If not acceptable, additional submittals will be required until they are approved.
- F. **Warranty:** The Contractor shall guarantee all concrete work for a period of one (1) year after acceptance against defective workmanship and materials and shall keep the same in good order and repair. The City of Aurora Project Manager shall determine whether the Contractor shall repair any concrete work or portions thereof during the guarantee period.

1.4 **Delivery, Handling and Storage**

- A. **Hauling Time:** Discharge all concrete transmitted in a truck, mixer, agitator or other transportation device within ninety (90) minutes after the mixing water has been added.
- B. **Reinforcement:** Delivery reinforcement to the project site bundled, tagged and marked. Use tags indicating bar size, lengths, and other information corresponding to the Drawings. Store concrete reinforcement materials at the site in a manner to prevent damage and accumulation of dirt or excessive rust.
- C. **Extra Water:** Deliver concrete to the job in exact quantities required by the design mix.

1.5 **Job Conditions**

- A. **Cold Weather Protection:** When concrete is placed with ambient temperatures below 40°F, the Contractor shall provide satisfactory methods and means to protect the mix from injury by freezing. The aggregates, or water, or both, shall be heated in order to place the concrete at temperatures between 50°F and 100°F. Placing of concrete may be started in the morning if the Contractor desires, but shall be discontinued at 3:00 p.m. of the same day if freezing weather threatens. The concrete or aggregates shall be protected during transit, mixing before and after placing, as directed by the City of Aurora Project Manager to retain all heat possible in the concrete mix. After the concrete has been placed, the Contractor shall provide sufficient protection such as cover, canvas, framework, heating apparatus, etc., to enclose and protect the concrete and maintain the temperature of the concrete at not less than 50°F

until at least sixty percent (60%) of the design strength has been attained. Except as provided above, cold weather concreting shall be in accordance with ACI-306. If in the opinion of the City of Aurora Project Manager the protection is not adequate, concreting shall cease until conditions or procedures are satisfactory to the City of Aurora Project Manager.

- B. **Hot Weather Placement:** Except by written authorization, concrete shall not be placed if the temperature of the plastic concrete cannot be maintained at 90°F or lower. The placement of concrete in hot weather shall comply with ACI-305.

1.6 Clean Up

The discharge of water containing waste cement to adjacent waterways, wetlands, other properties, etc., is prohibited. The cleaning of cement truck delivery chutes, except in designated concrete washout areas, is prohibited at the job site.

PART 2 PRODUCTS

2.1 Concrete Materials

- A. **Cement:** All cement used in concrete work shall be Portland cement conforming to all requirements of AASHTO M-85. A 5□ sack, Type I with six percent (6%) ±□ one percent (1%) entrained air shall be used. Type II or Type IIA shall be used.

- B. **Admixtures:** The use of calcium chloride in the production of high early strength concrete is strictly prohibited.

- 1. Air entraining admixtures shall conform to AASHTO M-154, latest edition.
- 2. Water reducing and set controlling admixtures shall conform to AASHTO M-194, according to the following types; Type A - Water Reducing, Type B - Retarding, Type D - Water Reducing and Retarding, Type E - Water Reducing and Accelerating.
- 3. Written approval of the City of Aurora Project Manager shall be obtained prior to the use of any admixture except air entrained admixtures. Application of admixtures shall be per the manufacturer's specifications.

- C. **Water:** Water for concrete shall be clean and free from sand, oil, acid, alkali, organic matter or other deleterious substances. Water from public supplies or which has been proven to be suitable for drinking is satisfactory.

D. Fine Aggregates:

- 1. Composition: Fine aggregates shall consist of natural sand composed of clean, hard, durable, uncoated grains, preferably of siliceous materials.
- 2. Deleterious Substances: The maximum percentage of deleterious substances shall not exceed the following values:

Materials finer than a 200 mesh sieve.....	3% by weight
Shale	1% by weight
Coal and lignite.....	3% by weight
Clay lumps.....	1% by weight
Other deleterious substances.....	2% by weight

The sum of the percentages of the above deleterious substances shall not exceed five percent (5%) by weight. All fine aggregates shall be free from injurious amounts of alkali and organic impurities.

3. Grading: Fine aggregates shall be well graded from coarse to fine, and when tested by standard laboratory sieves shall conform to the following:

Passing No. 4 sieve	95% - 100%
Passing No. 16 sieve	45% - 80%
Passing No. 50 sieve	10% - 30%
Passing No. 100 sieve	2% - 10%

4. Other Requirements: The fine aggregate shall conform to AASHTO M-6.

E. Coarse Aggregate:

1. Composition: Coarse aggregate shall consist of crushed limestone, trap rock, granite, washed gravel or other approved inert materials having clean, hard, strong, durable pieces, from adherent coatings and conforming to the requirements of these specifications.
2. Deleterious Substances: The maximum percentages of deleterious substances shall not exceed the following values:

Material finer than a 300 mesh sieve	1% by weight
Coal and lignite.....	3% by weight
Clay lumps.....	3% by weight
Soft fragments.....	3% by weight
Other deleterious substances.....	2% by weight

The sum of the percentages of the above deleterious substances shall not exceed five percent (5%) by weight.

3. Grading: Coarse aggregate shall be well graded between the limits specified and shall conform to the following requirements:

Percentages by weight passing standard laboratory sieve having square openings.

Max. Size of Aggregate (In inches)	1 1/2"	1"	3/4"	1/2"	3/8"	No. 4
2"	90-100		35-70		10-30	0-5
1"		90-100		25-60		0-10
3/4"		100	90-100		20-55	0-10

4. Other Requirements: Coarse aggregate shall conform to the requirements of AASHTO M-80.

- F. **Fibermesh Reinforcement**: Concrete Engineered Reinforcing Fibers shall be one hundred percent (100%) virgin polypropylene, collated, fibrillated fibers from Fibermesh Company,

4019 Industry Drive, Chattanooga, TN, 37416. Fibermesh fibers shall only be used in areas indicated on the Drawings and in strict accordance with the manufacturer's recommendations as to type and amount. The fiber manufacturer or approved distributor shall provide the services of a qualified employee for a pre-job meeting and initial job start-up. Only fibrillated fibers designed and manufactured specifically for use in concrete from one hundred percent (100%) virgin polypropylene and so certified by the manufacture shall be acceptable.

- G. **Colored Concrete Paving:** Bomanite colored concrete paving from Colorado Hardscapes (750-8200). Apply per manufacturers specifications to area designated on plan. Color to be from manufacturers standard color palette. Apply sealer per manufacturers specifications.
- H. **Patterned Concrete Paving:** Bomanite patterned concrete paving from Colorado Hardscapes (750-8200). Construct per manufacturers specifications to area designated on plan.

2.2 Mixes

A. Concrete Material:

- 1. The proportions of materials to be used shall produce a workable concrete having a slump of one to four inches (1"-4") and with air content and minimum twenty-eight (28) compressive strength as indicated in paragraph C.3 of AASHTO specifications. Minimum cement content shall be five hundred seventeen (517) pounds (5□) sacks) per cubic yard with maximum thirty-six (36) gallons of water (including surface water on the aggregates per cubic yard of concrete (maximum water/cement ratio = 0.58).
- 2. An approved air-entraining agent shall be used in all concrete.
- 3. The class of concrete specified shall conform to the following:

	Max. Size Coarse Aggregate	(f'c) 28-day Strength (PSI)	Percent Air
Class I	3/4"	4,500	6% ±□ 1%

- 4. Class I will be used in all concrete work including sidewalks, pavement and footings.

- B. **Ready Mix Concrete:** Ready-mix concrete shall conform to all the requirements of these specifications and ASTM C-94. The City of Aurora Project Manager shall have free access to the mixing plant at all times. Ready-mixed concrete shall be continuously mixed or agitated from the time the water is added until the time of use. During this period of mixing, the drum shall be operated at the speed specified by the manufacturer of the equipment. The concrete shall be completely discharged from the truck mixer or truck agitator within one and one-half (1½) hour after the cement comes in contact with aggregates. The entire contents of the mixer shall be discharged before recharge and the mixer shall be cleaned frequently. The organization supplying ready-mixed concrete shall have sufficient plant and transportation facilities to assure continuous delivery of concrete at the required rate. Hand mixed concrete shall not be permitted except by written approval of the City of Aurora Project Manager.

2.3 Formwork Materials

- A. **Forms:** All forms must be new or in excellent, clean condition. Forms shall conform to the shape, lines and dimensions as shown on the Drawings. Unexposed surfaces shall have

forms of No. 2 common (or better) lumber. Coat forms with a non-staining form release agent that will not discolor or deface the surface of the concrete. Forms shall not be disturbed until the concrete have adequately hardened.

- B. **Ties:** The Contractor shall have forms ties approved by the City of Aurora Project Manager prior to use. The form ties shall be adjustable in length to permit tightening of forms and of such type to leave no metal closer than one inch (1") of the surface and no holes or depressions larger than seven-eighths inch (7/8") diameter. Ties shall be free from rust, be oil free and have no coatings applied to the metal.

2.4 **Concrete Reinforcing**

A. **Reinforcing Steel:**

1. Reinforcing steel bars shall conform to the requirements of the "Standard Specifications for Deformed Billet-Steel Bars for Concrete Reinforcement" of the American Society of Testing Materials. Bars shall be new billet-steel conforming to AASHTO M-312 of the grade shown on the Drawings.
2. Reinforcing steel, before being placed, shall be thoroughly cleaned of coatings that will destroy or reduce bond. Reinforcement shall be carefully formed to the dimensions indicated on the drawings. It shall not be bent or straightened in a manner that will injure the material. **THE USE OF HEAT IN BENDING BARS SHALL NOT BE PERMITTED.** Bars with kinks or bends that are not shown on the drawings shall not be used. Reinforcing steel shall be accurately placed and secured against displacement by using annealed iron wire of not less than No.18 gauge, or suitable clips at intersections and where necessary. Bars shall not be supported by metal chairs or spaces, precast mortar blocks nor metal hangers. Reinforcing bars shall not be spliced at points of maximum stress. Splices, where permitted, shall be as specified in ACI-318. All reinforcing steel shall be placed in the position and at the spacing shown in the drawings with the tolerances specified in ACI-301, Section 5.4.

2.5 **Joint Materials and Sealants**

- A. **Joint Material:** Joint material shall conform to AASHTO specifications according to type as follows:

Concrete joint sealer, hot poured elastic	M-301
Preformed expansion joint filler (bituminous type).....	M-213
Preformed sponge rubber and cork expansion joint filler	M-153
Preformed expansion joint fillers-nonextruding and resilient bituminous.....	M-33

- B. **Joint Sealant:** Joint sealant shall be used in any place that is designed or can be expected to carry water and shall be recessed three-eighths inch (3/8").
- C. **Sealant Backer Rod:** Compressible rod stock of polyethylene foam, neoprene foam, or other flexible, permanent, durable, non-absorptive material as recommended for compatibility with sealant by the sealant manufacturer.

2.6 **Curing Compound**

Curing compound for concrete shall be a white-pigmented, liquid, membrane-forming compound conforming to AASHTO M-148, Type II, Class B.

PART 3 EXECUTION

3.1 Inspection

A. Permits:

1. Permits shall be obtained before the work begins.
2. The Contractor shall call for inspection, giving twenty-four (24) hours notice, and inspection shall be made before placement of concrete can occur.
3. The Contractor shall obtain written notice of Inspector's approval to place materials after inspection has been made and before concrete is placed.
4. Written notice of rejection shall be given to the Contractor in the event any of the aforementioned conditions are not met and work shall be halted until such time as corrective action is taken.
5. Copies of the drawings and the permit shall be on the job site and available to the Inspector.

B. Concrete Flatwork: The contractor shall examine sub-grades and conditions under which flatwork is to be provided for conformance to specified tolerance and notify the City of Aurora Project Manager of conditions detrimental to the proper and timely completion of the work. Do not proceed until unsatisfactory conditions have been remedied in a manner acceptable to the City of Aurora Project Manager.

C. Drilled Caissons: The contractor shall set the caissons at the correct depth, location and according to the detail as shown on the drawings. The contractor shall have the caisson locations staked and approved prior to the drilling. The caissons shall be drilled, inspected by the City of Aurora inspectors and the concrete poured on the same day.

3.2 Preparation

Before depositing concrete, debris shall be removed from the space to be occupied by the concrete and the forms, including any existing concrete surfaces, shall be thoroughly wetted. Concrete shall not be placed until all forms and reinforcing steel have been inspected and approved by the City of Aurora Project Manager.

3.3 Subgrade Preparation

The sub-grade shall be in a moist condition at the time the concrete is placed. It shall be thoroughly wetted a sufficient time in advance of the placing of the concrete to insure that there will be no puddles or pockets of mud when the concrete is placed, but shall not be allowed to dry out before the concrete is placed. Subgrade under which the concrete shall be placed shall be thoroughly compacted to ninety-five percent (95%) of Standard Proctor density as determined by AASHTO T99 or T180, depending on soil type. The subgrade shall be cleared of any loose material. All soft and yielding material and other portions of the subgrade which will not compact readily when rolled or tamped shall be removed as directed and replaced with suitable material, placed and compacted as specified.

3.4 Forming

- A. **Form Erection:** The use of earth as a form will not be allowed. Lap forming with dressed lumber or plywood will not be allowed on curbs. Forms shall conform to shape, lines and dimensions shown on the drawings and shall be substantial and sufficiently tight to prevent leakage of mortar. Forms shall be properly braced or tied to prevent position, shape and lateral stability, and shall provide sufficient strength to carry construction operations and material dead loads without deflection or vibration. Forms shall be so designated as to be capable of needed adjustments and shall be carefully watched as work proceeds with all faults promptly corrected. Where finished concrete is to remain exposed, joints shall be spaced as shown on the Drawings. Provide access panels in formwork for cleanout or pouring as required. In forming for all curbs, top of forms shall be top of curbs.
- B. **Form Inspection:** Prior to pouring concrete, forms shall be inspected and approved by the City of Aurora Project Manager or construction inspector.
- C. **Form Removal:** The Contractor, or his/her superintendent, shall be present at the time the forms are removed and shall be responsible for the safety of this operation at all times. Forms in general may be removed from vertical surfaces after twenty-four (24) hours from the time of placing and from horizontal surfaces seventy-two (72) hours from the time of placing. If after stripping of forms any concrete is found to be formed other than as shown on the drawings or is out of alignment or level or shows a defective surface, it shall be considered as not conforming with these specifications and shall be removed and replaced by the Contractor at his/her own expense.

3.5 Placement of Reinforcement

- A. **Reinforcing Steel:** The minimum clear cover reinforcing steel shall be as specified in ACI-301, Section 5.5, unless otherwise shown on the drawings.

Minimum Clearance

Bottom bars on soil bearing foundations and slabs	3 inches
Bars adjacent to surfaces exposed to weather or earth backfill:	
For bars more than 3/4" in diameter	2 inches
For bars 3/4 " or less in diameter	1 1/2 inches
Interior Surface: Slabs, walls, joints with 1 3/8" diameter or smaller.....	3/4 inch

- B. **Fibermesh Reinforcement:** For all concrete pavement, fibermesh reinforcement shall be added to concrete mix at the rate of one and one-half (1½) pounds per cubic yard and shall be mixed in strict accordance with the manufacturer's recommendations. Fibermesh shall be uniformly distributed throughout the concrete after mixing at the rated time and speed.

3.6 Placing Concrete

- A. **Placing:** Concrete shall be transported from the mixer to the place of final deposit as rapidly as possible by methods, which prevent separation or loss of ingredients. Concrete shall be deposited in the forms as nearly as practicable in its final position to avoid separation. It shall be deposited in continuous layers, the thickness of which generally shall not exceed twelve inches (12"). Concrete shall be placed in a manner that will avoid segregation and shall not be dropped freely more than four feet (4'). If segregation occurs, the City of Aurora Project Manager shall require the concrete to be removed and replaced at the Contractor's expense. Concrete shall be placed in one (1) continuous operation, except where keyed construction joints are shown on the drawings or as approved by the City of Aurora Project Manager. Delays in excess of forty-five (45) minutes may require removal and replacement of the pour,

as determined by the City of Aurora Project Manager.

- B. **Vibrating:** Concrete shall be vibrated in areas that are in excess of four inches (4") thick. Care shall be taken in vibrating concrete to vibrate only to bring a continuous film of mortar to the surface. Vibration shall stop before any segregation of the concrete occurs. Mechanical vibrators shall be of an approved type as specified in ACI-309, Chapter 5. Vibrators shall not be used to move or spread concrete.
- C. **Workability:** The consistency of the concrete shall be kept uniform for each class of work and shall be checked by means of slump test or Kelly Ball tests. The workability of the concrete shall be verified by the City of Aurora Project Manager. Concrete shall at all times be of such consistency that it can be worked into corners and angles of the forms and around joints, dowels and tie-bars using acceptable construction methods without causing excessive spading, segregation or undue accumulation of water or laitance on the surface. If any concrete fails to conform to the proportions of the approved mix design, such concrete shall not be incorporated into the work, but shall be discarded off the project site as waste material at the Contractor's expense. **NO WATER MAY BE ADDED AT THE JOB SITE WITHOUT THE PERMISSION OF THE CITY OF AURORA PROJECT MANAGER OR INSPECTOR.** If approval is obtained and water is added at job site, slump tests shall be run and test cylinders cast following the addition of water.

3.7 Curing

- A. All concrete, regardless of temperature, weather or season, shall be protected from premature drying for a period of not less than seven (7) days after the concrete is poured. Where concrete is being protected from freezing, the time period for concrete saturation shall be one (1) day less than that for frost protection.
- B. The application rate shall be as per manufacturer's recommendation (approximately 150 square feet/gallon). Curing will not be required longer than seventy-two (72) hours if high early strength concrete is used. It shall be the Contractor's responsibility to protect the concrete being cured, from the elements, traffic and vandalism. Curing methods shall be applied to those surfaces covered by forms as soon as the latter are removed. Inadequate protection by the Contractor shall be cause for suspension of concreting operations and damaged concrete shall be replaced at the expense of the Contractor.

3.8 Finishing

- A. **Procedure:** Exposed faces of curbs and sidewalks shall be finished to true lines and grades as shown on the Drawings. The surface shall be floated to a smooth but not slippery finish. Pavement shall be broomed and edged. After completion of the brooming and before the concrete has taken its initial set, all edges and joints shall be tooled with an edger having a three-eighths inch (3/8") radius.
- B. **Types of Finishes:**
 - 1. Ordinary Surface Finish: Immediately following the removal of forms, all fins and irregular projections shall be removed from all surfaces except those, which are not to be exposed or waterproofed. All expansion and control joints in the completed work shall be left carefully tooled and free of all mortar and concrete. Joint filler shall be left exposed for its full length with clean and true edges.
 - 2. Broom Finish: All concrete bike paths and sidewalks, unless otherwise specified.

3. Colored Concrete Finish.
4. Patterned Concrete Finish.
5. Exposed Aggregate Finish.
6. Sawcut Pattern Finish.
7. Masonry Coating Finish.
8. Special-See Plans.

C. Spacing of Joints:

1. Expansion Joints: Expansion joint material shall be provided at the following locations and shall be in place prior to the placing of concrete:
 - a. Between new concrete pavement and concrete curb.
 - b. Between new concrete pavement and existing concrete.
 - c. As shown on the Drawings.
 - d. As directed by the City of Aurora Project Manager.
 - e. A maximum of 200 feet apart.
2. Score Joints: Unless shown otherwise, score joints shall be placed at maximum intervals of six feet (6') on concrete paths to control random cracking unless shown otherwise. Joints shall be sawed to a minimum thickness of one-quarter (1/4) of the total thickness.

- D. **Markings**: Concrete shall have the name of the Contractor and the year of construction impressed thereon using letters not less than one inch (1") high and three-eighths inch (3/8") deep.

3.9 Backfilling

When side forms are removed and the concrete has gained sufficient strength, the space adjoining the concrete shall be properly backfilled with suitable material, properly compacted and graded per drawings. The Contractor at his expense shall repair existing pavement, which is damaged during construction.

3.10 Field Quality Control

- A. **Testing Definitions**: Concrete materials and operations will be tested as directed by the City of Aurora Project Manager and as herein stipulated.
1. Testing Agency: Any person, partnership or corporation performing the herein specified sampling, testing and reporting.
 2. Contractor: Any person, partnership or corporation constructing concrete slabs, walls or structures for or within the City of Aurora.
 3. City: City of Aurora

4. Engineer: The director of Public Works or an authorized representative.
 5. City of Aurora Project Manager: City Landscape Architect or an authorized City representative.
- B. **Testing Agency**: The required testing services shall be performed by the testing agency designated by the City of Aurora Project Manager.
1. A representative of the testing agency shall inspect, sample and test material and production of the concrete as required by the City of Aurora Project Manager. When it appears that any materials furnished or work performed by the Contractor fails to fulfill specification requirements, the testing agency shall report such deficiency to the City of Aurora Project Manager.
 2. The testing agency shall report all test and inspection results to the City of Aurora Project Manager immediately after they are performed. All test reports shall include the exact location of the work at which the batch represented by a test was deposited. Report of strength test shall include detailed information on storage and curing of specimen prior to testing, project number, and where concrete was placed (curb, sidewalk, paving, etc.).
 3. The testing agency or its representative is not authorized to revoke, alter, relax, enlarge or release any requirements of the contract documents, nor approve or accept any portion of the work.
- C. **Responsibilities and Duties of the Contractor**: The Contractor shall provide the Testing Agency with the following:
1. Furnish any necessary labor to assist the designated testing agency in obtaining and handling samples at the project.
 2. Advise the City of Aurora Project Manager sufficiently in advance (twenty-four [24] hours minimum) of concrete operations to allow for scheduling of concrete quality tests and for the assignment of personnel.
 3. Provide and maintain for the sole use of the testing agency adequate facilities for safe storage and proper curing of concrete test specimen on the project site as required by AASHTO T-23.
 4. The use of testing services in no way relieves the Contractor of the responsibility to furnish material and construct in full compliance with the Contract Documents.
- D. **Tests Paid for by the Contractor**: The following services shall be performed by the designated testing agency at the expense of the Contractor:
1. Tests for mix design purposes, the results of which shall immediately reported to the Contractor and the City of Aurora Project Manager. When pumped concrete is to be used, a separate mix design shall be required. Mix designs shall be in accordance with ACI-211 and 304, as applicable.
 2. Additional testing and inspection required because of changes in materials or proportions proposed by the Contractor.
 3. Additional testing of materials or concrete occasioned by the Contractor's failure by test or

inspection to meet specification requirements.

4. Obtaining and testing core samples where less than twenty-four (24) hours notice prior to pouring was given, which resulted in now being able to obtain proper test samples. Obtaining the testing cores shall be in accordance with ASTM C-42. Concrete in the area represented by a core test will be considered adequate if the average strength of the core is equal to at least eighty-five percent (85%) of the specified strength and if no single core is less than seventy-five percent (75%).
 5. Failure of the Contractor to furnish testing as herein described shall be sufficient cause for rejection of the material in question.
 6. Minimum call out charges and standby time shall be paid by the Contractor when they result from failure to place concrete on schedule for any reason, except by action of the Engineer.
- E. **Tests Paid for by City:** The following testing services shall be performed by the designated agency at the expense of the City.

1. Conduct strength test of the concrete during construction in accordance with the following procedures:
 - a. Secure composite samples in accordance with AASHTO T-141.
 - b. Mold and cure specimens from each sample in accordance with AASHTO T-23. The maximum time between sampling and casting the cylinders or beams shall be forty five (45) minutes. If they cannot return to the laboratory and cast within forty five (45) minutes, they shall be cast in the field and transported to the laboratory in twelve (12) to twenty-four (24) hours at no additional cost to the City. The City of Aurora Project Manager shall determine which of the following test series shall be taken. If the specified strength is not obtained at twenty-eight (28) days, two (2) cylinders are to be broken at forty five (45) days.

Field Cured Test Series

Four (4) cylinders:

- Two (2) to be broken at seven (7) days.
- Two (2) to be broken at fourteen (14) days.

Lab Cured Test Series

Six (6) cylinders:

- Two (2) to be broken at seven (7) days.
- Two (2) to be broken at twenty-eight (28) days.
- Two (2) to be broken at forty-five (45) days.

2. Determine slump of the concrete sample of each strength test and whenever consistency of concrete appears to vary, or when directed by the City of Aurora Project Manager, in accordance with AASHTO T-119.
3. Determine air content of the concrete sample of each strength test in accordance with AASHTO T-152 (pressure method), T- 196 (volumetric method) or T-121 (gravimetric method).
4. Sample concrete at point of placement and perform required test, and other testing or inspection service as required.

5. Additional testing and inspection required because of changes in material or proportion, when the City of Aurora Project Manager directs such changes.
- F. **Strength Testing:** Strength requirements shall be in accordance with ACI-301, Chapters 16 & 17. The strength level of the concrete will be considered satisfactory so long as the averages of all sets of three (3) consecutive strength tests results equal or exceed the specified strength, f'c, and no individual strength test results fall below the specified strength f'c by more than 500 psi. Should the strength level be unsatisfactory, the Project Manager shall have the right to require changes in proportions to apply on the remainder of the work. In the event of failure of test specimens for any portion of the work, which in the opinion of the City of Aurora Project Manager will endanger the safety of the structure, that portion of the structure shall be rejected and shall be removed and replaced at the Contractor's expense.
- G. **Final Surface Test:** Prior to acceptance of the work, the Contractor shall test the surfaces with a ten-foot (10') straight edge. Any areas deviating more than one-quarter inch (1/4") from the correct surface level indicated shall be removed and replaced by the Contractor at his/her expense as directed by the City of Aurora Project Manager.

3.11 **Repairs and Replacement**

- A. **Concrete Defects:** Defects that require replacement including excessive honeycombing, damage due to stripping for forms, loose pieces of concrete, uneven or excessive ridges at form joints and bulges due to movement of the forms. Defective areas shall be removed and replaced at the Contractor's expense upon notification by the City of Aurora Project Manager.

Bolt holes & tie-rod holes and minor imperfections, as approved by the City of Aurora Project Manager, shall be filled with dry patching mortar composed of one (1) part Portland cement and two (2) parts of regular concrete sand (volume measurement) and only enough water so that after the ingredients are mixed thoroughly the mortar will stick together. Mortar repairs shall be placed in layers and thoroughly compacted by suitable tools. Care shall be taken in filling rod and bolt holes so that the entire depth of the hole is completely mortared. The mortar mix proportions described above are approximate.
- B. **Finishing Defects:** Should the finish work applied to concrete walls, curbs or flatwork be determined to be unacceptable in appearance to the City of Aurora Project Manager due to either poor workmanship or materials, based on a comparison to the approved concrete flatwork submittals, the Contractor shall remove and replace the wall, curb or flatwork at his expense and as directed by the City of Aurora Project Manager. The minimum size of concrete flatwork replacement shall be 5' x 10'. The concrete pavement shall be cut to full depth prior to removal.
- C. **Connections with Existing Sidewalks:** Where new sidewalk construction abuts existing sidewalks or curbs, the work shall be accomplished so that grade of new work matches that of existing features.
- D. **Opening to Traffic:** Walks shall not be opened to pedestrian traffic for at least twenty-four (24) hours after placement. The Contractor shall maintain suitable barricades to comply with the foregoing requirements and will be responsible for repair of any vandalism or damage occurring during this time.
- E. **Repairs to Existing Sidewalks:** Where repairs are made to existing sidewalks, all edges of the old sidewalk allowed to remain shall be saw cut to a minimum depth of two inches (2"). No rough edges will be permitted where new construction joins the old. Unless directed by the City of Aurora Project Manager, no section less than six feet (6') in length shall be placed

or left in place.

PART 4 MEASUREMENT AND PAYMENT

4.1 Measurement

Measurement for concrete work is determined by the type of work performed. Walks, pad and flatwork shall be measured by square foot of surface. Raised concrete edger and playground curb edger will be measured on a linear foot basis. Caissons shall be measured per each.

4.2 Payment

- A. Concrete work shall be paid for at the contract unit price as bid in the Proposal. The price bid in the Proposal shall include the cost of furnishing all labor, equipment and materials necessary for completing the work in place as specified in the Drawings.
- B. The cost of furnishing and installing joints and filler, sealant, curing materials, welded wire mesh and fibermesh reinforcement shall be included in the price of the concrete.

END OF SECTION

PAINTING
09900

PART 1 GENERAL	1
1.1 Work Included	1
1.2 Related Work	1
1.3 References.....	1
1.4 Submittals	1
1.5 Delivery, Storage & Handling.....	1
1.6 Project Conditions.....	2
PART 2 PRODUCTS	2
2.1 Materials	2
PART 3 EXECUTION.....	2
3.1 Inspection.....	2
3.2 Preparation	2
3.3 Workmanship	3
3.4 Painting Schedule - Exterior	3
3.5 Cleanup.....	4
3.6 Extra Stock.....	4
PART 4 MEASUREMENT & PAYMENT	4
4.1 Measurement & Payment	4

PAINTING
09900

PART 1 GENERAL

1.1 Work Included

- A. Furnish & Install.
 - 1. Paint all exterior surfaces of metal not specifically excluded.
- B. **Exclusions:** In addition to material obviously not requiring paint such as glass, floor, tile, etc. Do not paint and finish:
 - 1. Surfaces indicated by the finish schedule to remain unfinished.
 - 2. Factory finished surfaces indicated to be factory finished.

1.2 Related Work

Railing Specification 05520.

1.3 References

- A. **Reference Standards:** Comply with requirements of Painting Specification Manual prepared by the Painting and Decorating Contractors of America, latest Edition. Where more stringent requirements are specified herein, they shall take precedence.

1.4 Submittals

- A. **Color Schedule:** The Project Manager will provide a color sample to the Contractor showing paint color selected. Color selections will be made by the Project Manager from color systems of recognized paint company. If materials of other manufacturers are used, colors must match those selected.
- B. **Paint & Stain Samples:** If requested by Project Manager, prepare and submit paint samples. Remake samples until accepted.
- C. **Materials List:** Immediately after award of the contract, submit a letter listing the brand and quality of each different material for use on the project. Materials list shall be accepted by the Project Manager before ordering materials.

1.5 Delivery, Storage & Handling

- A. **Delivery:** Deliver materials required for painting in unbroken packages bearing the brand and name of manufacturer. Order materials sufficiently in advance to be on the job when needed and deliver at the building in sufficient quantities so the work will not be delayed. No claim by the Contractor concerning unsuitability of any material specified or his/her inability to produce first-class work with the same, will be entertained unless such claim is made, in writing, to the material list submittal.
- B. **Storage and Mixing:** Assign a room or space in which to mix or store material. Provide galvanized mixing pans for this paint room or space in which paints shall be mixed. No mixing

of paint shall be done except in these pans. Empty containers bearing the name or brand of any manufacturer shall not be brought upon the premises for mixing of paint unless labels are canceled and containers are closely marked as to contents.

- C. **Inspection:** The paint storage area shall be open for periodic inspection by the Project Manager to insure only approved materials are being used.

1.6 **Project Conditions**

- A. **Environmental Requirements:** Do not finish outside surfaces in extreme cold, frosty, foggy or damp weather. In winter weather, finish only when the temperature is 50°F or over and surfaces are absolutely dry. Exterior painting shall not be allowed while dust is blowing.

PART 2 PRODUCTS

2.1 **Materials**

- A. **Acceptable Manufacturers:** The best quality materials as manufactured by Pittsburgh Paints will be acceptable. Other manufacturers will be considered upon proof that performance criteria meets that of specified coating.
- B. **Quality:** All products not specified by name shall be "best grade" or "first line" products or acceptable manufacturers. See Part 3 - Execution for materials required for this project. Where possible, materials shall be of a single manufacturer.

PART 3 EXECUTION

3.1 **Inspection**

Examine surfaces scheduled to receive paint and finishes for conditions that will adversely affect execution, permanence or quality of work and which cannot be put into an acceptable condition through preparatory work as included under Preparation. Report unsatisfactory conditions to the General Contractor in writing with copy to Project Manager.

3.2 **Preparation**

A. **General:**

1. Sand finishes on metal surfaces between coats to assure smoothness and adhesion of subsequent coats. Use extra fine sandpaper to avoid cutting the edge when sanding. Bring material flush with adjoining surfaces.
2. Surfaces shall be perfectly dry, clean and smooth before starting work. Fill cracks, holes or checks full and make smooth before finish is applied to surfaces.

- B. **Ferrous Metal:** Remove foreign material from unprimed metals with a wire brush and dust clean.

C. **Shop Painting:**

1. Remove scale, rust and other deleterious materials before applying the shop coat. Clean off heavy rust and loose mill scale in accordance with SSPC SP-2, "Hand Tool Cleaning"; SSPC SP-3, "Power Tool Cleaning", or SSPC SP-7, "Brush-off Blast Cleaning."

2. Remove oil, grease and similar contaminants in accordance with SSPC SP P-1, "Solvent Cleaning."
3. Immediately after surface preparation brush or spray on primer in accordance with the manufacturer's instructions and at a rate to provide a uniform dry film thickness of 2.0 mils for each coat. Use painting methods that will result in full coverage of joints, corners, edges and exposed surfaces.
4. Apply one (1) shop coat to fabricated metal items except apply two (2) coats of paint to surfaces inaccessible after assembly or erection. Change the color of the second coat to distinguish it from the first.

D. Shop Primed Metals:

1. Touch-up shop primed metals with a primer similar to the existing. Sand shop primer on metal work immediately before painting to remove grease and dirt film from surfaces.
2. All items to receive painting shall be delivered shop primed. Prior to final finish painting, the Contractor shall paint a small test area with finish paint to test for proper adhesion. In the event proper adhesion does not occur, the finish paint mixture shall be modified and repainted to provide proper adhesion.

E. Protection: Furnish and lay drop cloths or mask off areas where finishing is being done to protect floors and other work from damage during the execution of work. Where it becomes necessary to remove temporary coverings placed by others, replace same in proper manner.

F. Damage to Work of Others: Be responsible for any damage done to the work of other trades, repairing same to the satisfaction of the Project Manager. Replace any materials damaged to such an extent that they cannot be restored to their original condition.

G. Touch up Painting: Immediately after erection, clean field welds, bolted connections and abraded areas of shop paint and paint exposed areas with the same material used for shop painting. Apply by brush or spray to provide a minimum dry film thickness of 2.0 mils.

3.3 Workmanship

- A. Existing Surfaces:** If the surfaces are not in proper shape for painting, repair, rebuild or refinish, before proceeding with the work. Be responsible for any poor work caused by improper surfaces. The application of the first coat does not relieve the responsibility for the base. Do not apply any coats on either damp or wet surfaces and in no case until the preceding coat is dry and hard.
- B. General:** Spread materials evenly without runs or sagging of materials and thoroughly brush out. Sand work between coats.
- C. Colors:** Finish coat shall be color as selected by Project Manager. Tint primers to match finish coat. The railing and the picnic shelter colors shall match.
- D. Roller Applied:** Where paint or enamel is rolled on, use a fine nap roller so a nearly flat or orange peel texture is obtained.

3.4 Painting Schedule – Exterior

- A. Ferrous Metals (safety railing & picnic shelter):
 - 1. Surface Preparation: SSPC-SP6 Blast Cleaning.
 - 2. Shop Primer: Speedhide 6-208, 6-212 Rust Inhibitive Steel Primer by Pittsburgh Paints.
 - 3. Field Finish: PITT-TECH DTM Industrial Enamel by Pittsburgh Paints; 2.0 - 3.0 DFM (dry film mils).

3.5 Cleanup

- A. **Final Cleanup**: At the completion of work, remove all surplus materials, staging, rubbish; clean off all paint, varnishes, stains from floors, glass, walls, hardware and leave the premises in clean condition.

3.6 Extra Stock

- A. **Extra Paint**: At the completion of painting, deliver to the Owner one full gallon of each paint color and type used along with the color number or formula for each type. Epoxy and high performance coatings are not included.

PART 4 MEASUREMENT & PAYMENT

4.1 Measurement & Payment

- A. Measurement and payment of painting will not be paid for separately and shall be included in the contract unit price of the item which will receive painting.
- B. Contract price shall include the cost of furnishing all labor, equipment and materials necessary to complete the work as shown on the plans and called for in the specifications.

END OF SECTION

APPENDIX J

STANDARD DETAILS

Fences (F):

Open Space 3-Rail Fence	F-1.0
Open Space 3-Rail Fence – 54” Height	F-1.1
Cable Gate in Open Space Fence – Elevation	F-1.2
Cable Gate in Open Space Fence – Plan	F-1.3
Post & Cable Fence	F-2.0
Vehicle / Walk Gate in Post & Cable Fence – Elevation	F-2.1
Vehicle / Walk Gate in Post & Cable Fence – Plan	F-2.2
Cable Connection for Post & Cable Fence	F-2.3
Post & Cable Fence – Brace Section	F-2.4
Chain Link Fence (Heights 5’ & less)	F-3.0
Plains Conservation Center (PCC) Fence – Elevation	F-4.0
Plains Conservation Center (PCC) Fence – Brace & Corner Sections	F-4.1
Wildlife Fence – Elevation	F-6.0
Wildlife Fence – Brace & Corner Sections	F-6.1
Prairie Dog Fence – Elevation	F-7.0
Prairie Dog Fence – Plan & Section	F-7.1
Prairie Dog Fence – Corner Section	F-7.2

General Notes (G):

Layout Notes	G-1.0
Grading Notes	G-2.0

Irrigation (I):

Irrigation System Description	I-1.0
Irrigation Notes	I-1.1
Backflow Preventer – 2” & smaller	I-2.1
Backflow Preventer – 2.5” & larger	I-2.2
Backflow Enclosure	I-2.4
Electric Controller	I-2.5
Wiring Notes & Table	I-3.0
Trenching	I-3.1
Irrigation Sleeving	I-3.2
Thrust Blocking & Joint Restraints	I-3.4
Wire Splices	I-3.5
Wire Notes & Table – 2 wire system	I-3.6
Line Surge Arrestor with Grounding Rod	I-3.7
Isolation Valve	I-4.0
Electric Remote Control Valve	I-4.1
Manual Drain Valve	I-4.2
Quick Coupling Valve	I-4.3
Electric Remote Control Valve – 2 wire system	I-4.4
Pop-up Spray Head	I-5.0
Rotary Head	I-5.1
Subsurface Drip Layout	I-6.0
Filter (for drip irrigation)	I-6.1
Dripperline Start Connection	I-6.3
Subsurface Flush Valve	I-6.4
Spray Heads at Trees	I-6.6

<u>Landscape (L):</u>	
Planting Notes	L-1.0
Deciduous & Evergreen Tree	L-2.0
Shrub	L-2.1
Concrete Planter Curb	L-3.0
Mow Strip	L-3.1
<u>Medians (M):</u>	
Boulders in Median	M-1.2
<u>Playgrounds (P):</u>	
Playground Surfacing Against Sidewalk	P-1.0
<u>Restrooms (R):</u>	
Restroom with Vault Toilet	R-1.0
<u>Trails (T):</u>	
Multi-use Trail	T-1.0
Trail Intersections	T-1.1
Crusher Fines Trail	T-2.0
Low Water Trail Crossing	T-3.0
<u>Tree Protection (TP):</u>	
Tree Protection Notes	TP-1.0
Tree Preservation Measures – 1 side	TP-2.0
Tree Preservation Measures – 2+ sides	TP-2.1
Tree Protection Fencing	TP-3.0
Tree Protection on a Slope	TP-3.1
Retaining Wall at Existing Tree	TP-3.2

RAILS TO FACE PUBLIC PROPERTY UNLESS DIRECTED OTHERWISE BY THE PARKS & OPEN SPACE DEPARTMENT. FOOTINGS TO BE TOTALLY WITHIN THE OWNER'S PROPERTY.

2" X 6" PRESSURE-TREATED RAIL, ATTACH TO POSTS WITH 3/8" X 6" LAG SCREWS WITH WASHERS, 2 IN THE MIDDLE AND 2 AT EACH END.

2" X 4" WELDED WIRE MESH, 12.5g, FASTEN TO POSTS WITH HOG STAPLES, 3 PER POST IN SPACE BETWEEN RAILS. ATTACH TO RAILS WITH 4 STAPLES PER RAIL.

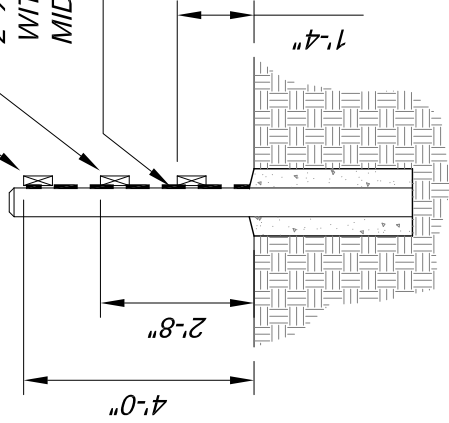

6" X 6" PRESSURE-TREATED POST, 1" CHAMFER ALL FOUR SIDES AT TOP

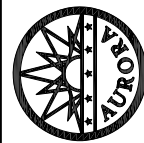
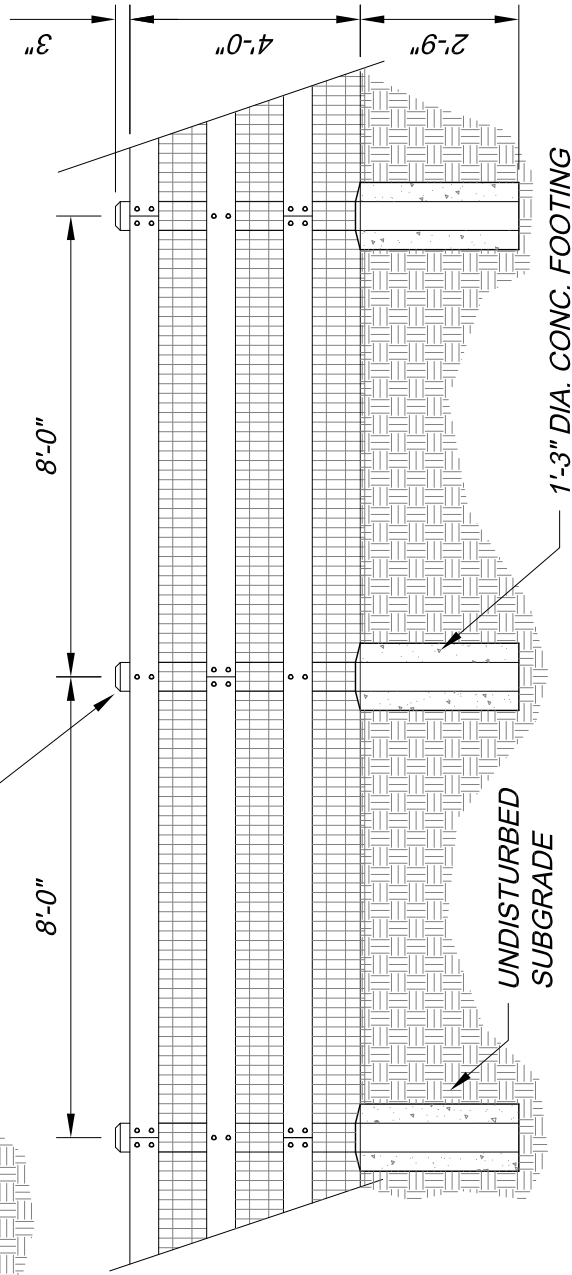

City of Aurora
Parks, Recreation & Open Space Dept.
Date: October 2020

**OPEN SPACE
3-RAIL FENCE**

**PROS
F-1.0**

RAILS TO FACE PUBLIC PROPERTY UNLESS DIRECTED OTHERWISE BY THE PARKS & OPEN SPACE DEPARTMENT. FOOTINGS TO BE TOTALLY WITHIN THE OWNER'S PROPERTY.

2" X 6" PRESSURE-TREATED RAIL, ATTACH TO POSTS WITH 3/8" X 6" LAG SCREWS WITH WASHERS, 2 IN THE MIDDLE AND 2 AT EACH END.

2" X 4" WELDED WIRE MESH, 12.5g, FASTEN TO POSTS WITH HOG STAPLES, 3 PER POST IN SPACE BETWEEN RAILS. ATTACH TO RAILS WITH 4 STAPLES PER RAIL.

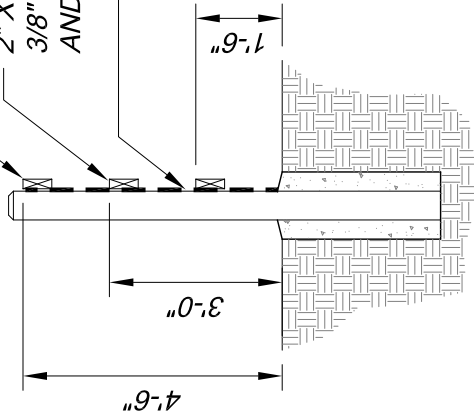

6" X 6" PRESSURE-TREATED POST, 1" CHAMFER ALL FOUR SIDES AT TOP

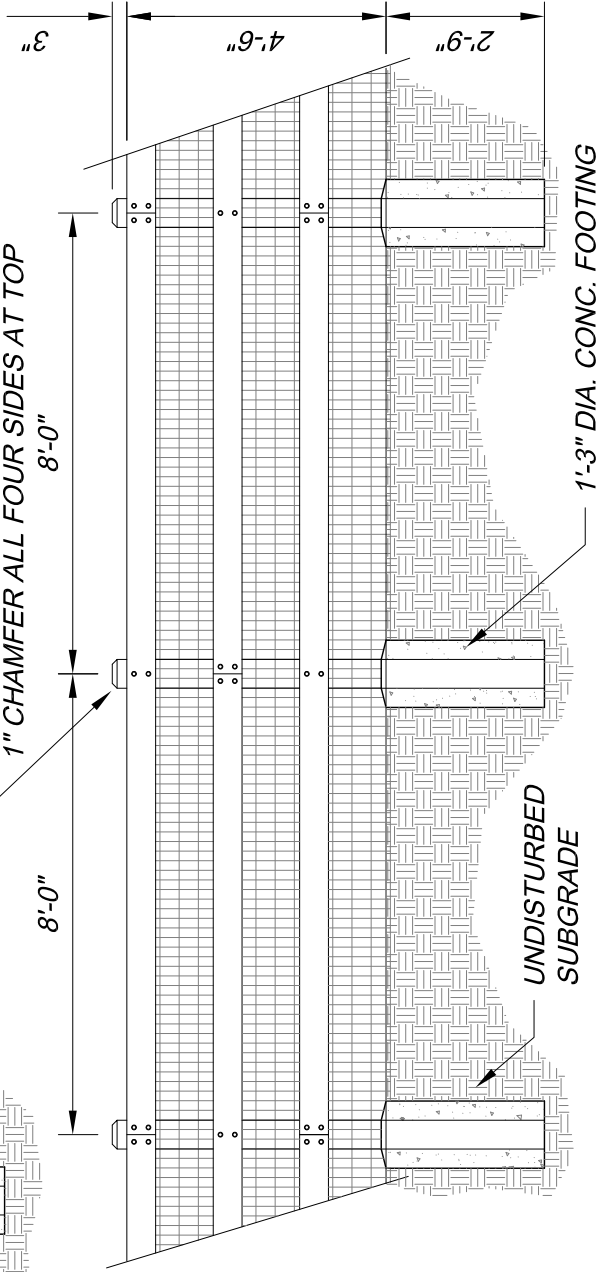

City of Aurora
Parks, Recreation & Open Space Dept.
Date: October 2020

OPEN SPACE 3-RAIL
FENCE -- 54" HEIGHT

PROS
F-1.1

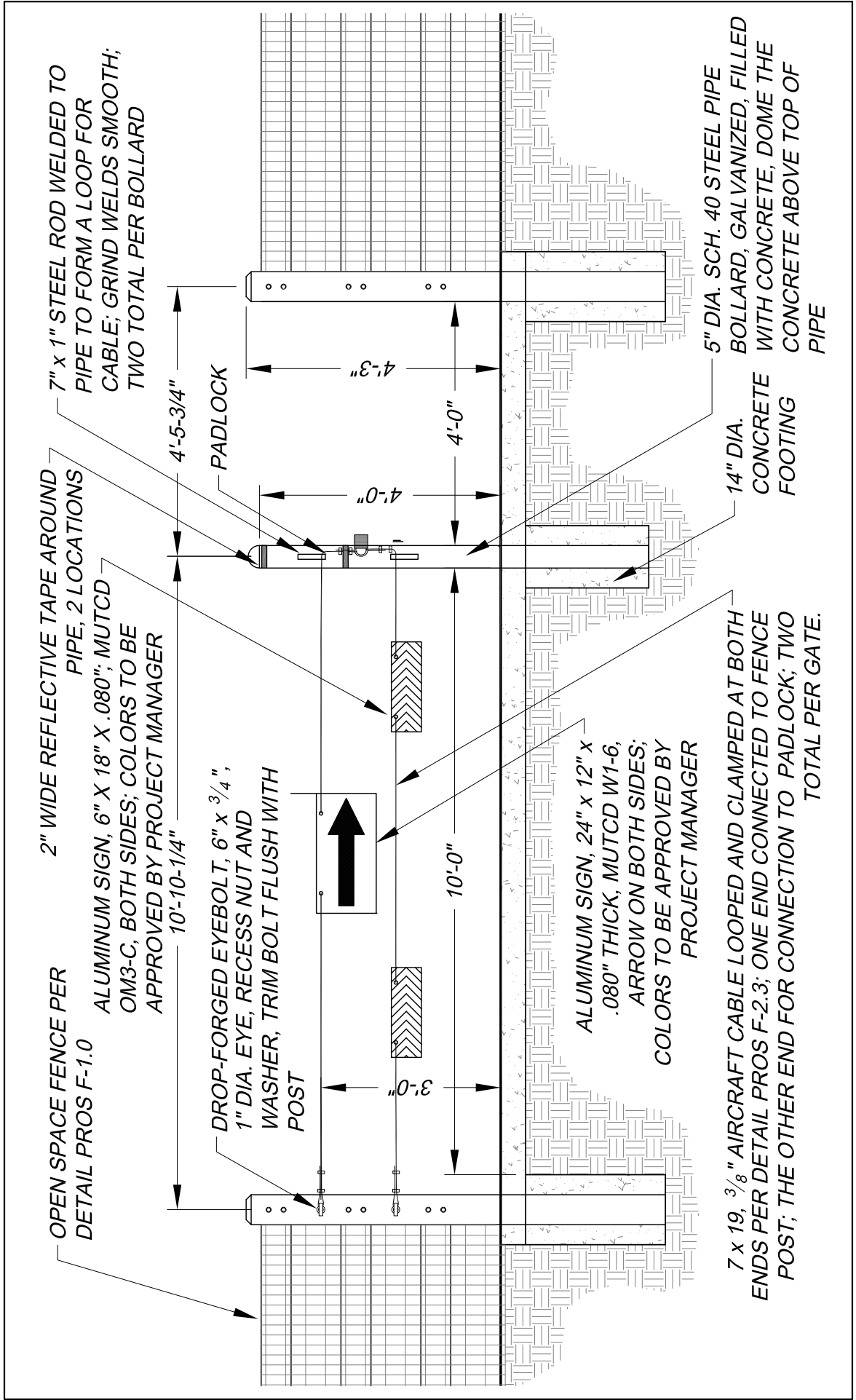

OPEN SPACE FENCE PER
DETAIL PROS F-1.0

2" WIDE REFLECTIVE TAPE AROUND
PIPE, 2 LOCATIONS

7" x 1" STEEL ROD WELDED TO
PIPE TO FORM A LOOP FOR
CABLE; GRIND WELDS SMOOTH;
TWO TOTAL PER BOLLARD

DROP-FORGED EYEBOLT, 6" x 3/4",
1" DIA. EYE, RECESS NUT AND
WASHER, TRIM BOLT FLUSH WITH
POST

PADLOCK

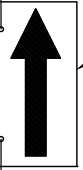

3'-0"

10'-0"

4'-0"

4'-3"

4'-0"

ALUMINUM SIGN, 24" x 12" x
.080" THICK, MUTCD W1-6,
ARROW ON BOTH SIDES;
COLORS TO BE APPROVED BY
PROJECT MANAGER

7 x 19, 3/8" AIRCRAFT CABLE LOOPED AND CLAMPED AT BOTH
ENDS PER DETAIL PROS F-2.3; ONE END CONNECTED TO FENCE
POST; THE OTHER END FOR CONNECTION TO PADLOCK; TWO
TOTAL PER GATE.

14" DIA.
CONCRETE
FOOTING

5" DIA. SCH. 40 STEEL PIPE
BOLLARD, GALVANIZED, FILLED
WITH CONCRETE, DOME THE
CONCRETE ABOVE TOP OF
PIPE



City of Aurora
Parks, Recreation & Open Space Dept.
Date: October 2020

CABLE GATE IN
OPEN SPACE FENCE

PROS
F-1.2

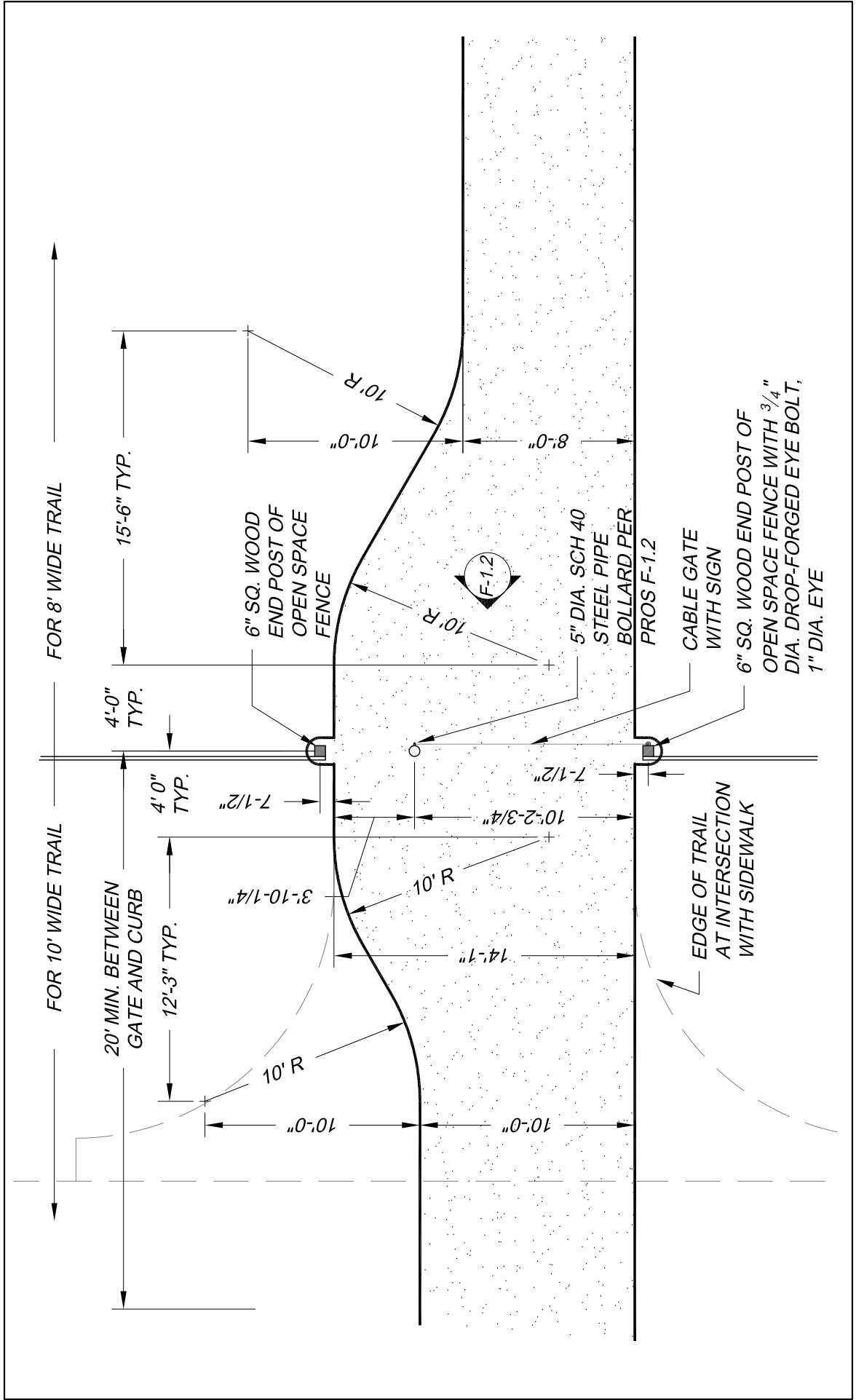

**PROS
F-1.3**

**CABLE GATE IN
OPEN SPACE FENCE**

City of Aurora
Parks, Recreation & Open Space Dept.
Date: October 2020



6" DIA. MIN. PRESSURE-TREATED WOOD POST

PLACE A WIRE ROPE CLIP ON EACH CABLE AT BOTH SIDES OF POSTS, 100 FEET APART

20'-0" MAX.

7 X 19, 3/8" GALVANIZED AIRCRAFT CABLE, TENSIONED PER PROJECT MANAGER; RETURNS AND CLIPS PER CABLE CONNECTION DETAIL

3/4" HOLE FOR 1/2" STEEL EYEBOLT, SEE CABLE CONNECTION DETAIL PROS F-2.3

AT END POSTS ADJACENT TO TRAILS, COUNTERSINK NUT AND TRIM OFF BOLT BEYOND NUT

SEE CABLE CONNECTION DETAIL PROS F-2.3

END POST

18" DIA. CONCRETE FOOTING

3" MIN. ALL SIDES

UNDISTURBED SUBGRADE
NOTE: DISPERSE SOIL REMOVED FROM HOLES

LINE POST

HAND TAMP TO DENSITY OF ADJACENT GRADE

EXISTING GRADE

6"

15"

27"

3'-0"

7'-0"



City of Aurora
Parks, Recreation & Open Space Dept.
Date: October 2020

POST & CABLE FENCE

**PROS
F-2.0**

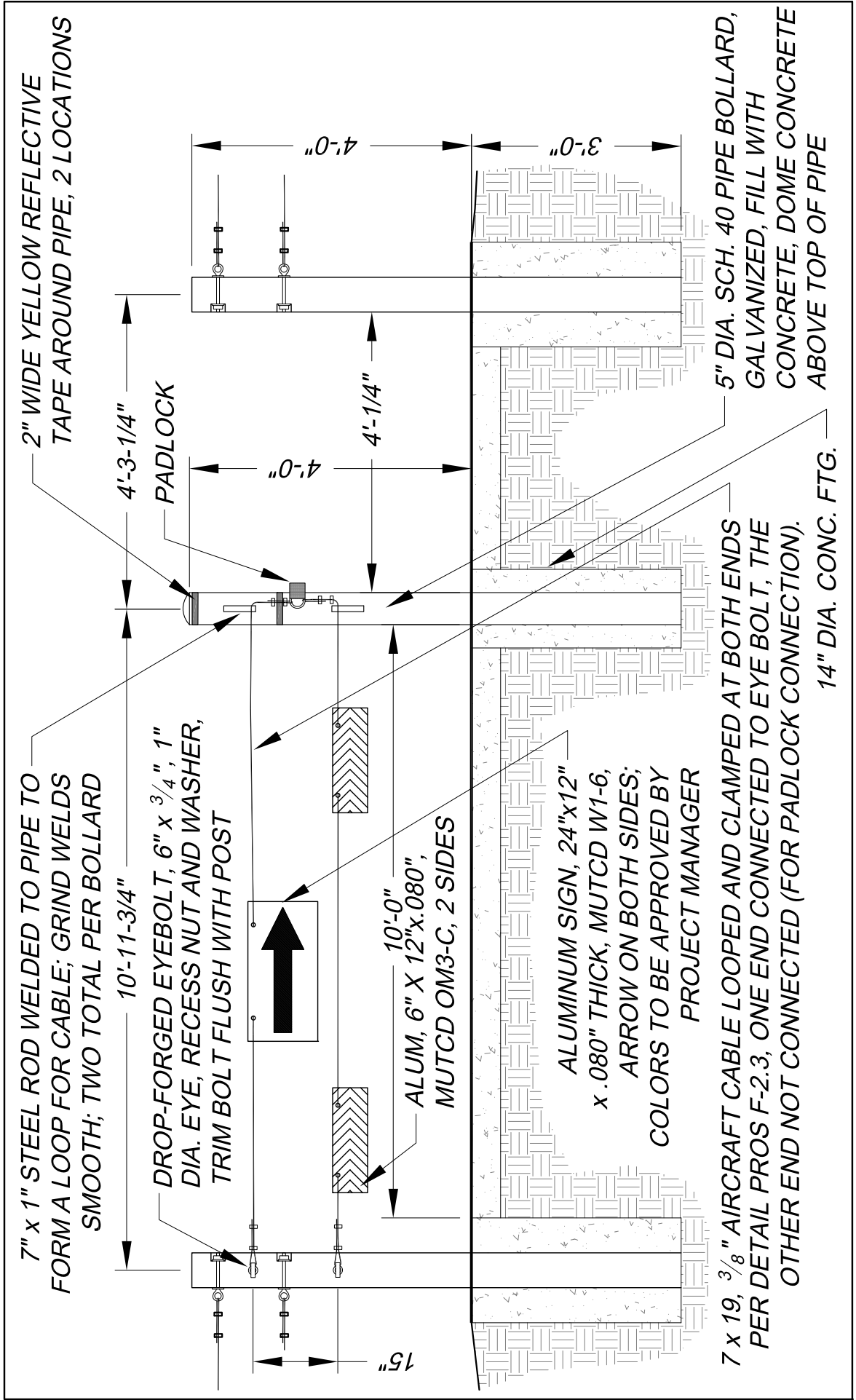

7" x 1" STEEL ROD WELDED TO PIPE TO FORM A LOOP FOR CABLE; GRIND WELDS SMOOTH; TWO TOTAL PER BOLLARD

2" WIDE YELLOW REFLECTIVE TAPE AROUND PIPE, 2 LOCATIONS

4'-3-1/4"

DROP-FORGED EYEBOLT, 6" x 3/4", 1" DIA. EYE, RECESS NUT AND WASHER, TRIM BOLT FLUSH WITH POST

PADLOCK

4'-0"

4'-1/4"

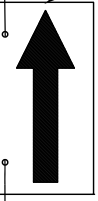

4'-0"

4'-0"



10'-0" ALUM, 6" X 12" X .080", MUTCD OM3-C, 2 SIDES

3'-0"

7 x 19, 3/8" AIRCRAFT CABLE LOOPED AND CLAMPED AT BOTH ENDS PER DETAIL PROS F-2.3, ONE END CONNECTED TO EYE BOLT, THE OTHER END NOT CONNECTED (FOR PADLOCK CONNECTION).

14" DIA. CONC. FTG.

5" DIA. SCH. 40 PIPE BOLLARD, GALVANIZED, FILL WITH CONCRETE, DOME CONCRETE ABOVE TOP OF PIPE

ALUMINUM SIGN, 24"x12" x .080" THICK, MUTCD W1-6, ARROW ON BOTH SIDES; COLORS TO BE APPROVED BY PROJECT MANAGER



City of Aurora
 Parks, Recreation & Open Space Dept.
 Date: October 2020

VEHICLE / WALK GATE IN
 POST & CABLE FENCE

PROS
 F-2.1

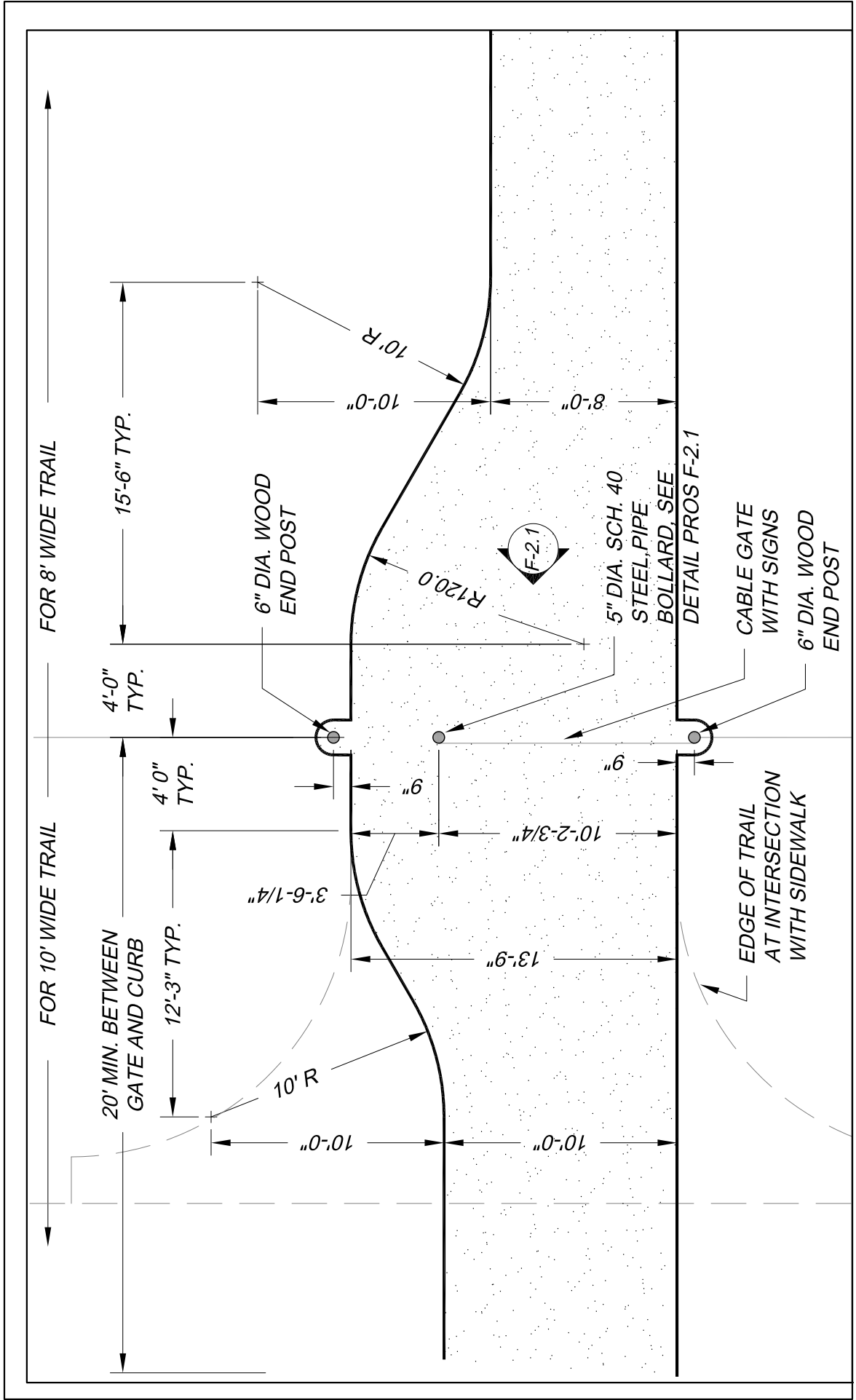

	<p>City of Aurora Parks, Recreation & Open Space Dept. Date: October 2020</p>	<p>PROS F-2.2</p>
<p>VEHICLE / WALK GATE IN POST & CABLE FENCE</p>		

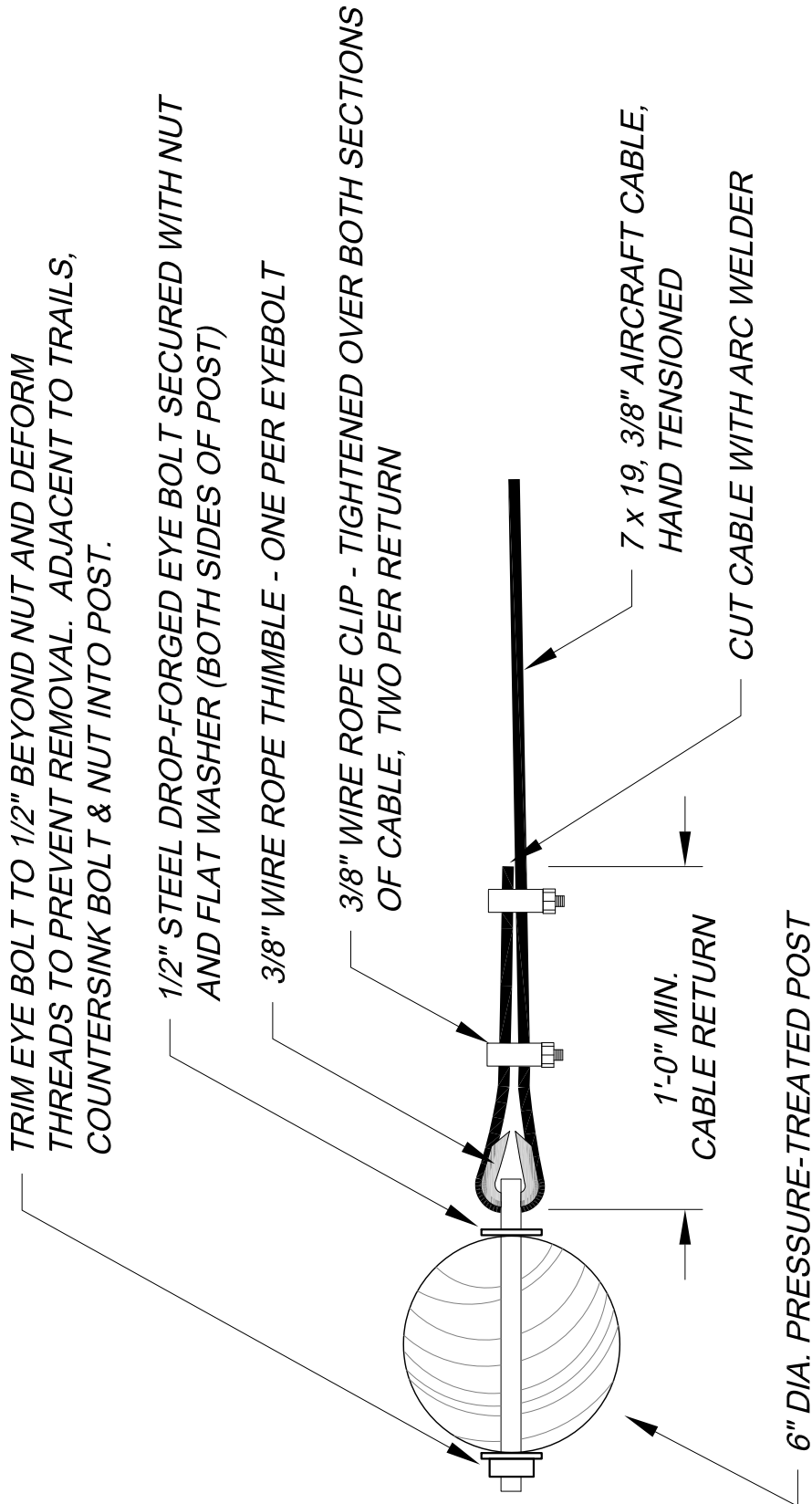

City of Aurora
 Parks, Recreation & Open Space Dept.
 Date: October 2020



CABLE CONNECTION FOR
 POST & CABLE FENCE

PROS
F-2.3

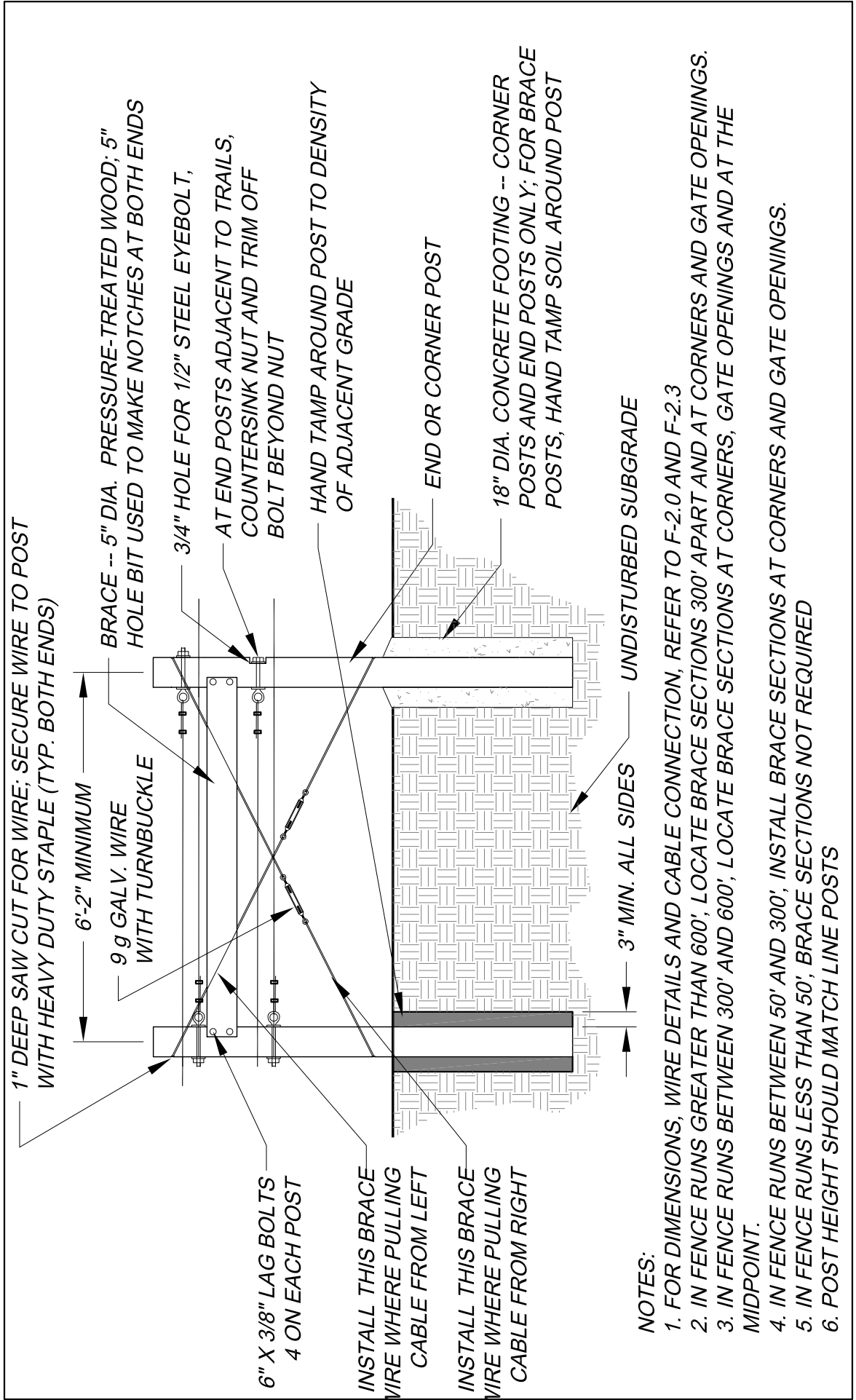

NOTES:

1. FOR DIMENSIONS, WIRE DETAILS AND CABLE CONNECTION, REFER TO F-2.0 AND F-2.3
2. IN FENCE RUNS GREATER THAN 600', LOCATE BRACE SECTIONS 300' APART AND AT CORNERS AND GATE OPENINGS.
3. IN FENCE RUNS BETWEEN 300' AND 600', LOCATE BRACE SECTIONS AT CORNERS, GATE OPENINGS AND AT THE MIDPOINT.
4. IN FENCE RUNS BETWEEN 50' AND 300', INSTALL BRACE SECTIONS AT CORNERS AND GATE OPENINGS.
5. IN FENCE RUNS LESS THAN 50', BRACE SECTIONS NOT REQUIRED
6. POST HEIGHT SHOULD MATCH LINE POSTS



City of Aurora
 Parks, Recreation & Open Space Dept.
 Date: October 2020

**POST & CABLE
 FENCE -- BRACE SECTION**

**PROS
 F-2.4**

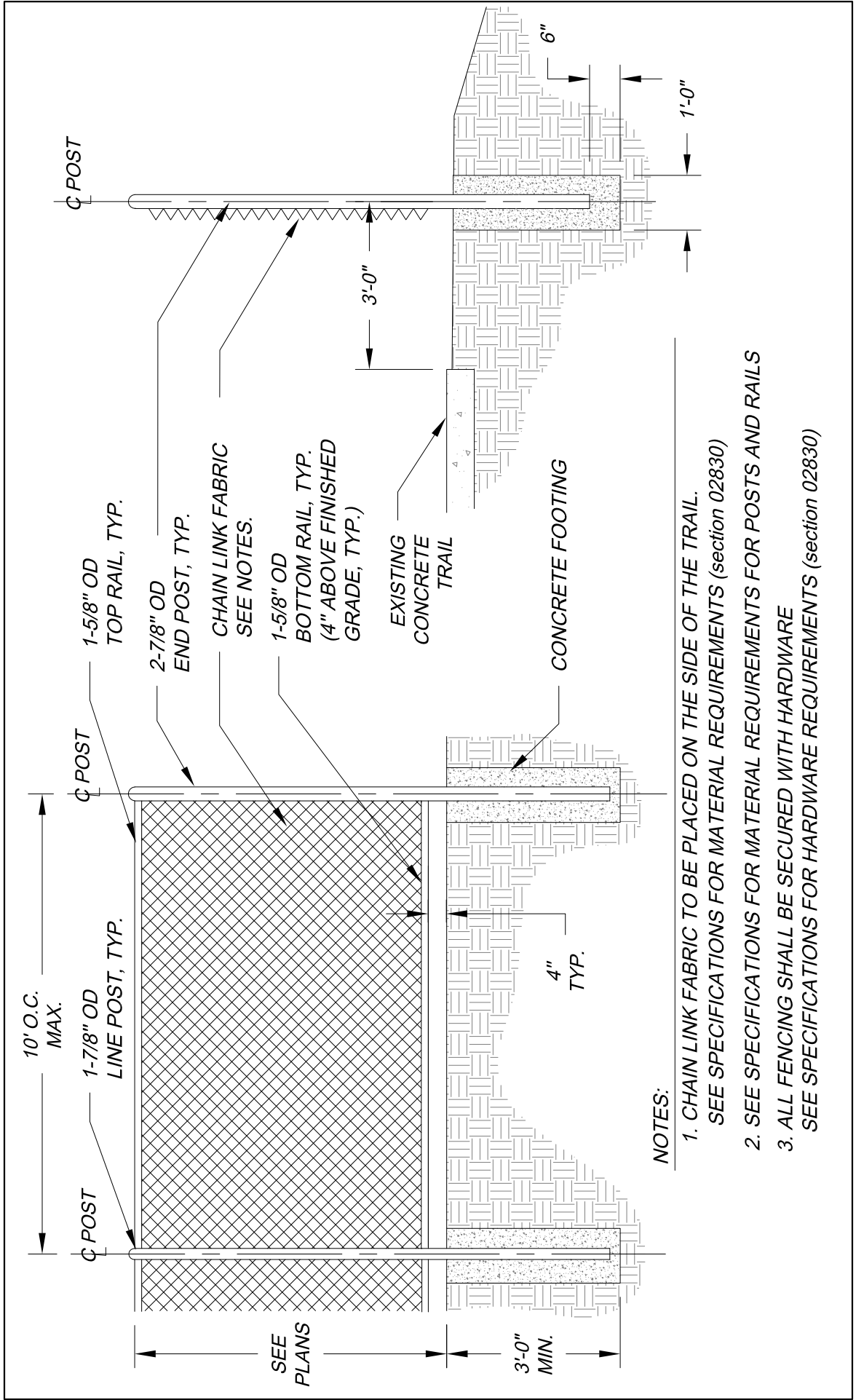

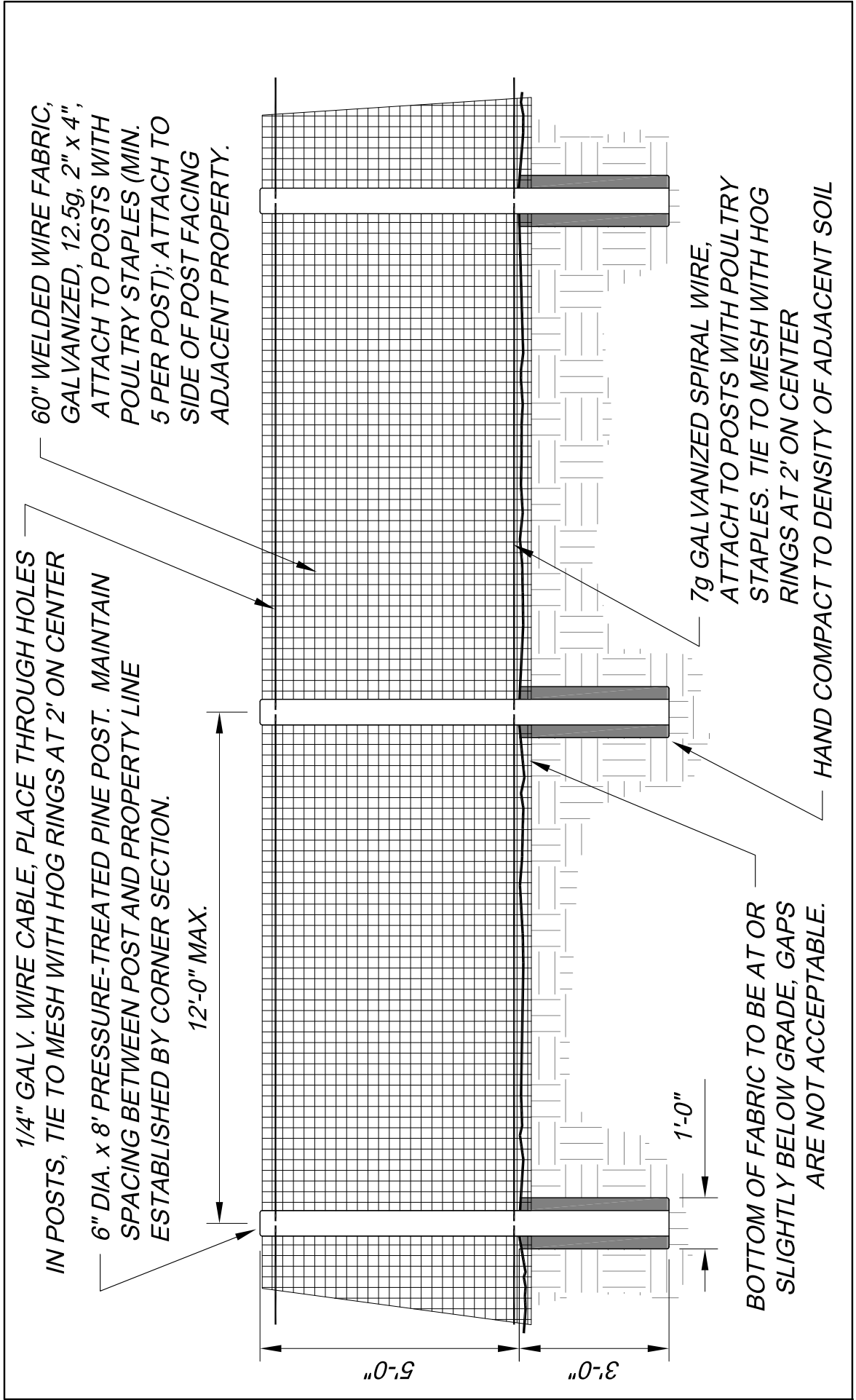

- NOTES:
1. CHAIN LINK FABRIC TO BE PLACED ON THE SIDE OF THE TRAIL.
SEE SPECIFICATIONS FOR MATERIAL REQUIREMENTS (section 02830)
 2. SEE SPECIFICATIONS FOR MATERIAL REQUIREMENTS FOR POSTS AND RAILS
 3. ALL FENCING SHALL BE SECURED WITH HARDWARE
SEE SPECIFICATIONS FOR HARDWARE REQUIREMENTS (section 02830)

	<p>City of Aurora Parks, Recreation & Open Space Dept. Date: October 2020</p>	<p>PROS F-3.0</p>
<p>CHAIN LINK FENCE -- HEIGHTS 5' & LESS</p>		

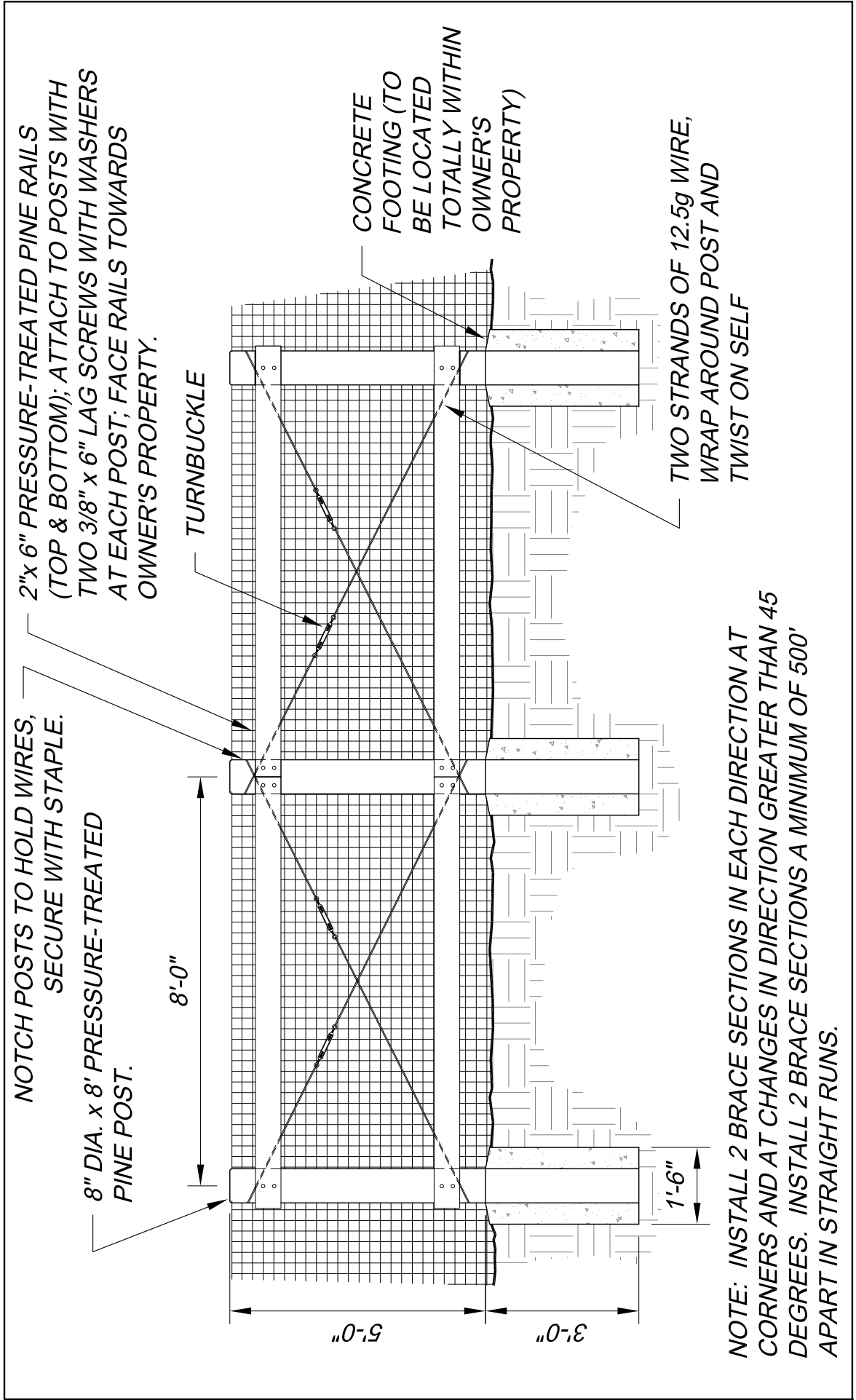

	<p>City of Aurora Parks, Recreation & Open Space Dept. Date: October 2020</p>	<p>PLAINS CONSERVATION CENTER (PCC) FENCE</p>	<p>PROS F-4.0</p>
---	---	---	-------------------------------------



	<p>City of Aurora Parks, Recreation & Open Space Dept. Date: October, 2020</p>	<p>PCC FENCE -- BRACE & CORNER SECTIONS</p>	<p>PROS F-4.1</p>
---	--	---	-------------------------------------

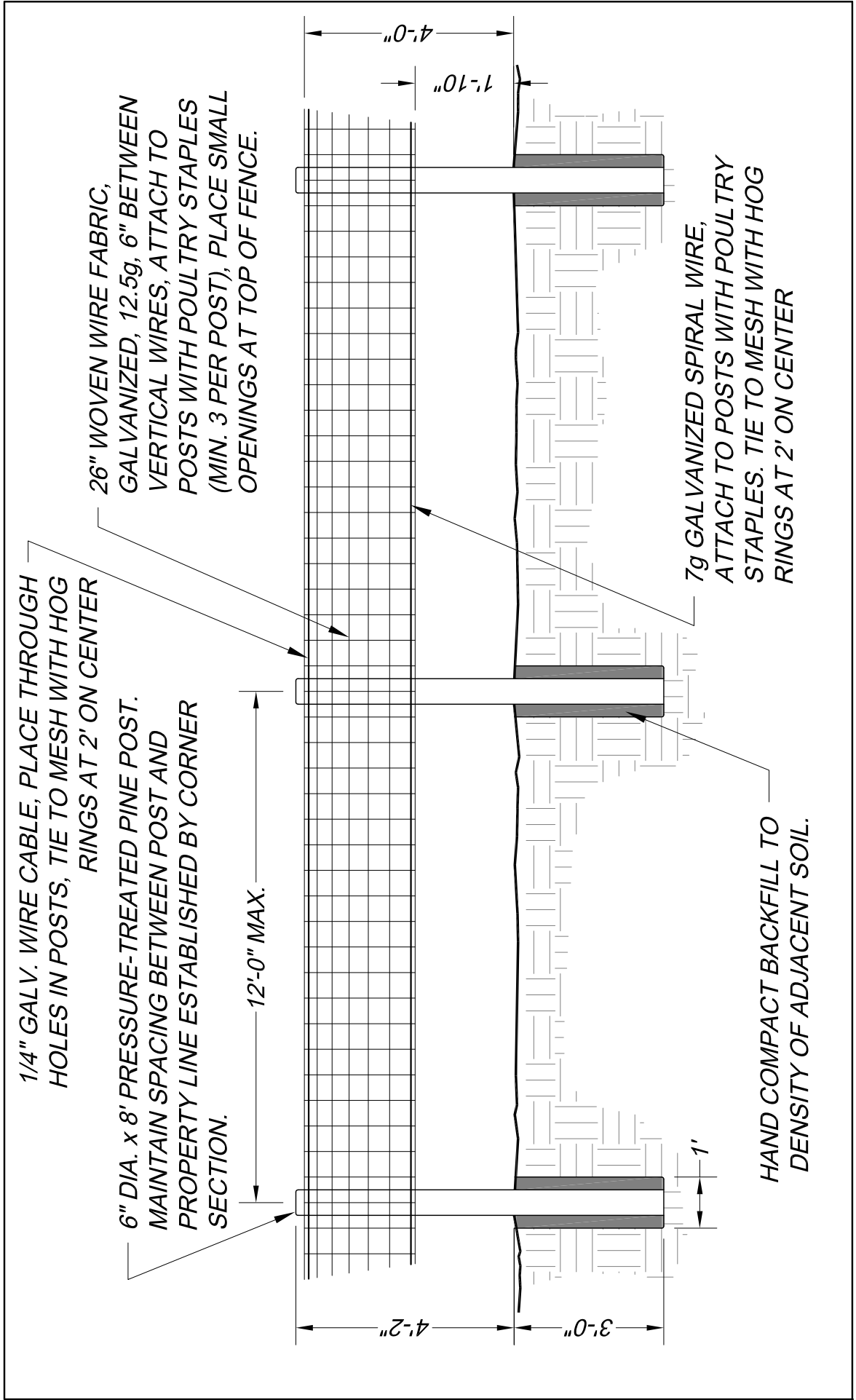

	<p>City of Aurora Parks, Recreation & Open Space Dept. Date: October 2020</p>	<p>WILDLIFE FENCE -- ELEVATION</p>	<p>PROS F-6.0</p>
---	---	--	-------------------------------------

NOTCH POSTS TO HOLD WIRES,
SECURE WITH STAPLE.

8" DIA. x 7'-2" PRESSURE-
TREATED PINE POST

2"x 6" PRESSURE-TREATED PINE
RAILS (TOP & BOTTOM), ATTACH
TO POSTS WITH TWO 3/8" x 6"
LAG SCREWS WITH WASHERS
AT EACH POST

TURNBUCKLE

CONCRETE
FOOTING (TO
BE LOCATED
TOTALLY WITHIN
OWNER'S
PROPERTY)

TWO STRANDS OF 12.5g WIRE,
WRAP AROUND POST AND
TWIST ON SELF

8'

4'-2"

3'

1'-6"

NOTE: INSTALL 2 BRACE SECTIONS IN EACH DIRECTION AT
CORNERS AND AT CHANGES IN DIRECTION GREATER THAN
45 DEGREES. INSTALL 2 BRACE SECTIONS A MINIMUM OF
500' APART IN STRAIGHT RUNS.



City of Aurora
Parks, Recreation & Open Space Dept.
Date: October 2020

WILDLIFE FENCE -- BRACE & CORNER SECTIONS

**PROS
F-6.1**

12.5g HIGH TENSILE STEEL WIRE WITH CLASS III GALVANIZATION,
 PLACED THROUGH GROMMETS AND THROUGH HOLES IN POSTS.
 ONE WIRE STRAINER PER 500' OF WIRE.

2" DIA. X 6' PRESSURE-TREATED PINE POST WITH
 1/2" HOLES; PLACE TENSION WIRE THROUGH
 HOLES IN POSTS.

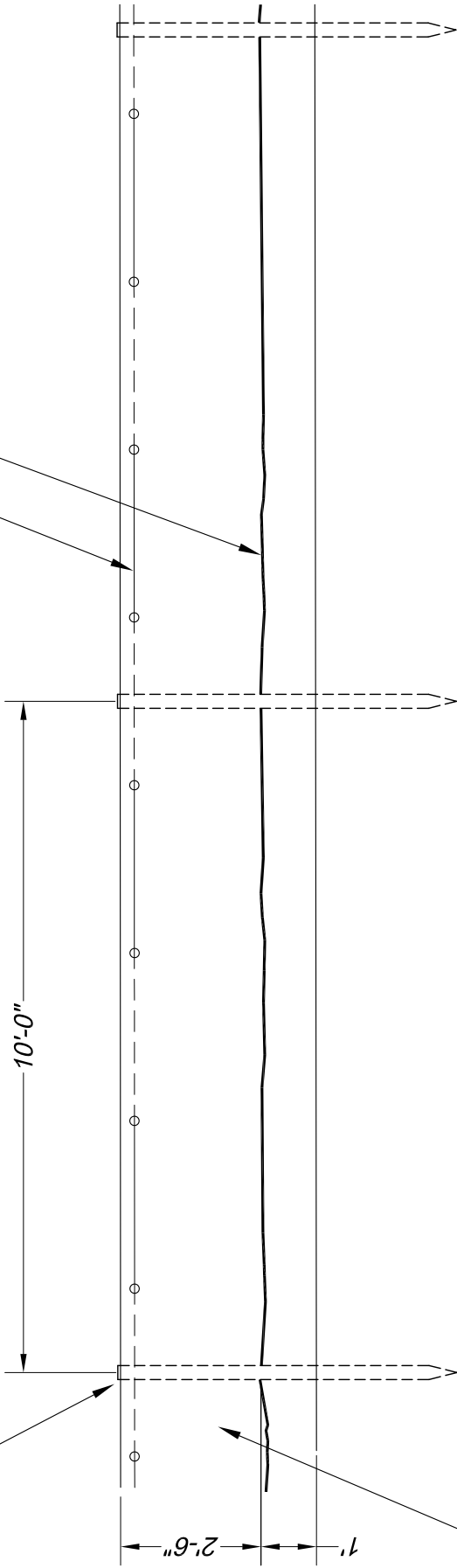

ARMORLON A-50 FABRIC; DARK GREEN COLOR; 42"
 WIDE, WITH A ROW OF GROMMETS AT 3" FROM
 TOP EDGE, 2'-6" ON CENTER HORIZONTALLY; AT
 JOINTS, OVERLAP FABRIC A MINIMUM OF 6";
 INSTALL ON PRAIRIE DOG SIDE OF POSTS.

NOTES:

1. STAPLES SHALL NOT BE USED TO
 ATTACH FABRIC TO WOOD POSTS
 OR OTHER WOOD MEMBERS.
2. AT END OF RUNS, ROLL FABRIC
 AROUND A PRESSURE-TREATED 2"
 x 2" AND NAIL TO END POSTS.



City of Aurora
 Parks, Recreation & Open Space Dept.
 Date: October 2020

PRAIRIE DOG FENCE --
 ELEVATION

PROS
F-7.0

2" DIA. X 6' PRESSURE-TREATED PINE POST, WITH POINTED END. PLACE TENSION WIRE THROUGH 1/2" HOLES IN POST

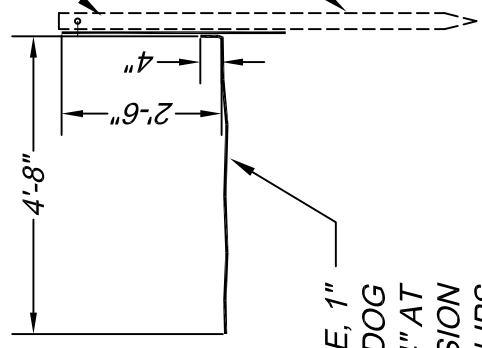

AFTER TRENCHING, INSTALL FABRIC AND POST; COMPACT SOIL AROUND POST AND AGAINST FABRIC TO EXISTING DENSITY OF ADJACENT UNDISTURBED SOIL

5' WIDE GALV. CHICKEN WIRE, 1" MAX. OPENING, ON PRAIRIE DOG SIDE OF FENCE; TURN UP 4" AT FABRIC; ATTACH TO TENSION WIRE WITH HOG CLIPS

SECTION

2" DIA. x 6' PRESSURE-TREATED PINE POST WITH 1/2" HOLES; 10' O.C.

ONE WIRE STRAINER PER 500 FEET OF WIRE.

12.5g HIGH TENSILE WIRE WITH CLASS III GALVANIZATION, PLACED THROUGH GROMMETS AND THROUGH HOLES IN POSTS.

ARMORLON A-50 FABRIC, DARK GREEN COLOR, WITH GROMMETS 2'-6" ON CENTER; INSTALL ON PRAIRIE DOG SIDE OF POSTS.

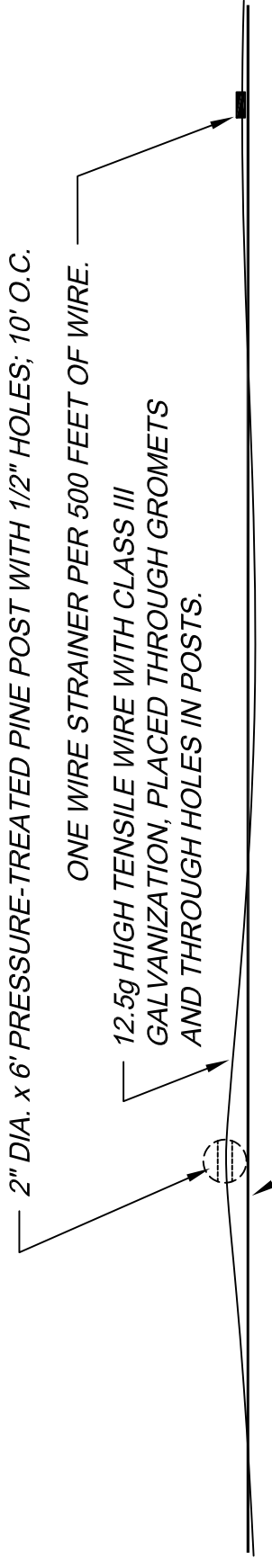

PLAN

City of Aurora
Parks, Recreation & Open Space Dept.
Date: October 2020



PRAIRIE DOG FENCE --
PLAN & SECTION

PROS
F-7.1

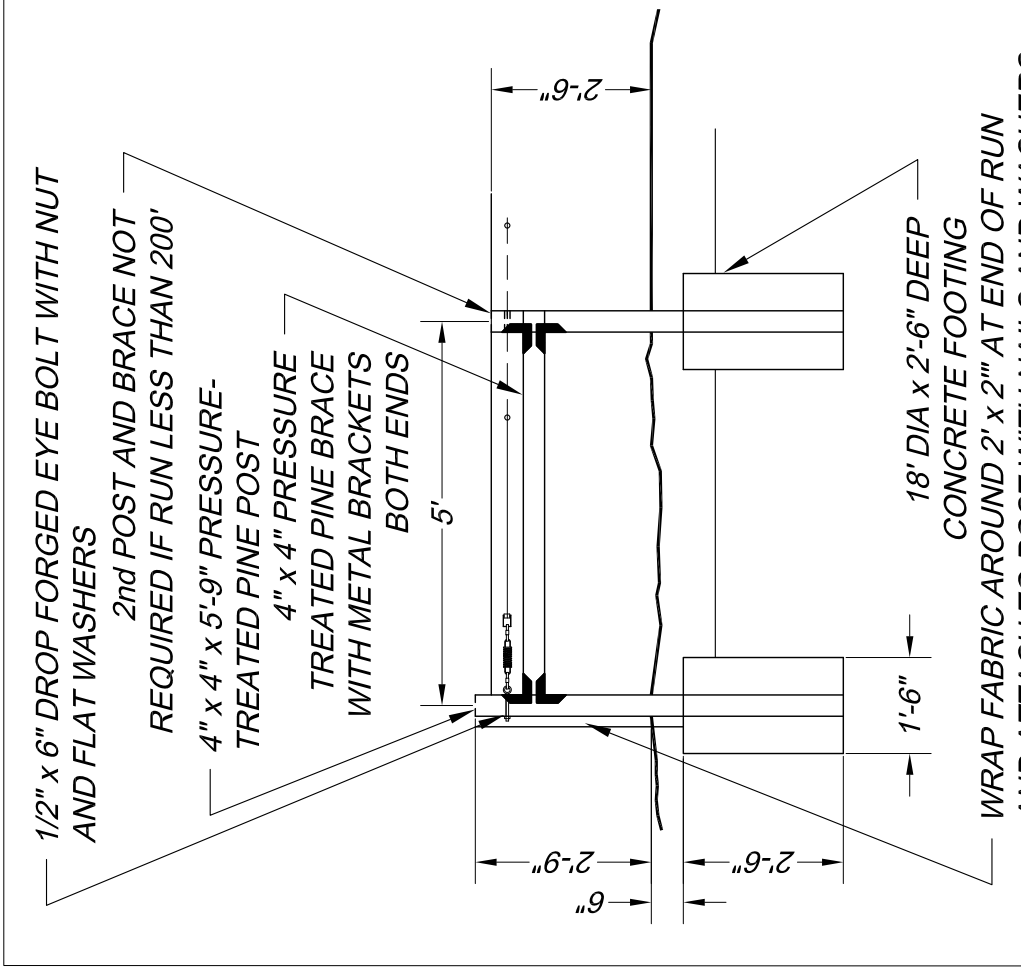

1/2" x 6" DROP FORGED EYE BOLT WITH NUT AND FLAT WASHERS

2nd POST AND BRACE NOT REQUIRED IF RUN LESS THAN 200'

4" x 4" x 5'-9" PRESSURE-TREATED PINE POST

4" x 4" PRESSURE TREATED PINE BRACE WITH METAL BRACKETS BOTH ENDS

18" DIA x 2'-6" DEEP CONCRETE FOOTING

WRAP FABRIC AROUND 2' x 2" AT END OF RUN AND ATTACH TO POST WITH NAILS AND WASHERS

NOTE: USE SIMILAR BRACE IN LINE WITH FENCE IN RUNS GREATER THAN 1000'; INSTALL METAL BRACKETS AT EACH END OF BRACE TO REINFORCE ATTACHMENT.

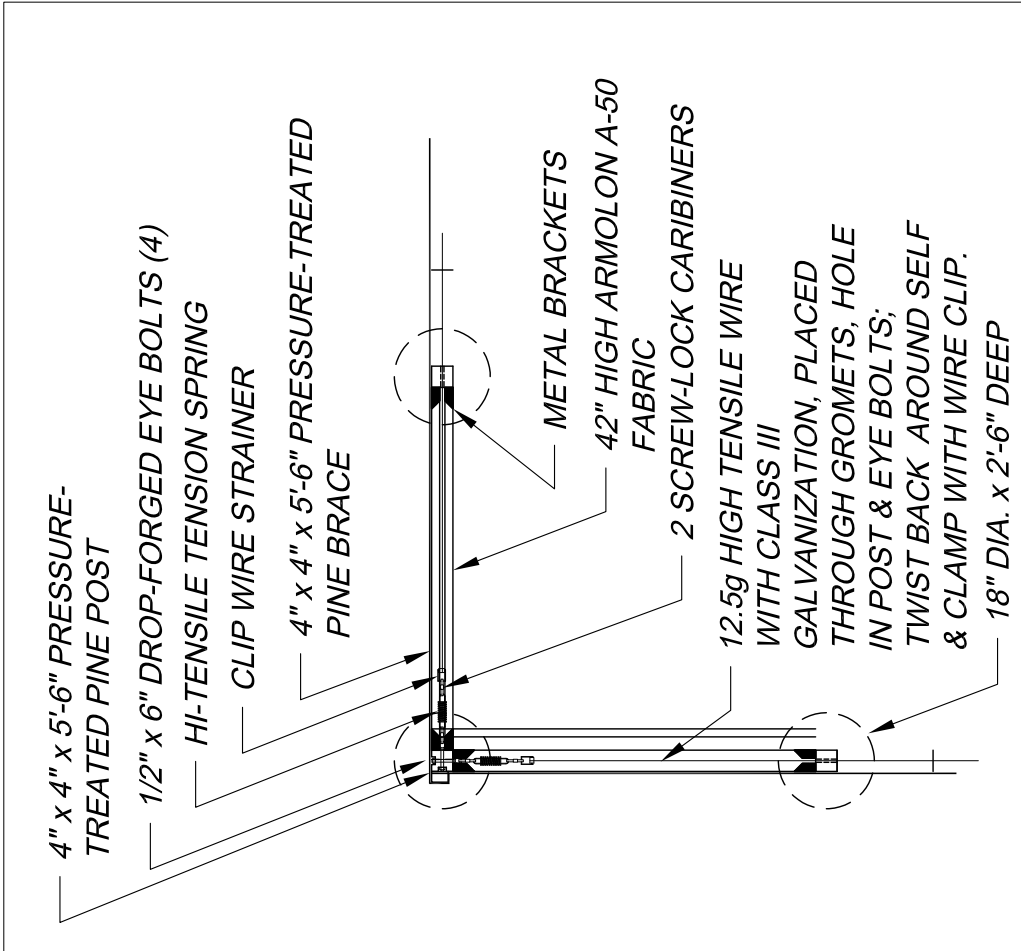

4" x 4" x 5'-6" PRESSURE-TREATED PINE POST

1/2" x 6" DROP-FORGED EYE BOLTS (4)

HI-TENSILE TENSION SPRING CLIP WIRE STRAINER

4" x 4" x 5'-6" PRESSURE-TREATED PINE BRACE

METAL BRACKETS

42" HIGH ARMOLON A-50 FABRIC

2 SCREW-LOCK CARBINERS

12.5g HIGH TENSILE WIRE WITH CLASS III

GALVANIZATION, PLACED THROUGH GROMETS, HOLE IN POST & EYE BOLTS; TWIST BACK AROUND SELF & CLAMP WITH WIRE CLIP.

18" DIA. x 2'-6" DEEP CONCRETE FOOTING



City of Aurora
Parks, Recreation & Open Space Dept.
Date: October 2020

PRAIRIE DOG FENCE --
CORNER SECTION

PROS
F-7.2

GENERAL LAYOUT NOTES

1. ALL SITE IMPROVEMENTS (PLAY EQUIPMENT, BENCHES, PICNIC TABLES, TRASH RECEPTACLES, DRINKING FOUNTAIN, ETC.) MUST BE FIELD SURVEYED AND STAKED BY CONTRACTOR. PROJECT MANAGER SHALL APPROVE STAKED LOCATION OF IMPROVEMENTS PRIOR TO INSTALLATION.
2. PROJECT MANAGER SHALL APPROVE FINAL STAKING BY CONTRACTOR OF ALL CONCRETE FLATWORK PRIOR TO CONSTRUCTION AND ALL FORM WORK PRIOR TO POURING.
3. ALL DIMENSIONS SHALL BE FIELD VERIFIED BY CONTRACTOR PRIOR TO CONSTRUCTION. ANY DEVIATION FROM THESE PLANS MUST BE APPROVED BY PROJECT MANAGER PRIOR TO CONSTRUCTION.
4. PRIOR TO EXCAVATION, UNDERGROUND UTILITIES MUST BE FIELD VERIFIED (SEE GENERAL NOTES).
5. INSTALL 1/2" EXPANSION JOINT MATERIAL AND CAULK JOINTS AT ALL VERTICAL INTERSECTIONS BETWEEN NEW AND EXISTING CONCRETE.
6. SEE SURVEY CONTROL DRAWING FOR ADDITIONAL CONTROL POINTS, MONUMENTS, AND BENCHMARKS.
7. SAW CUT CONTROL JOINTS SHALL BE SPACED AS INDICATED ON THE PLANS AND DETAILS. EXPANSION JOINTS SHALL BE PLACED EVERY 200 L.F. ALONG THE CONCRETE PATH. CONTRACTOR SHALL LAY OUT ALL CONTROL JOINTS AND EXPANSION JOINTS IN THE FIELD WITH THE PROJECT MANAGER.
8. SEE SPECIFICATION SECTION 02800 FOR MODEL NUMBER AND MANUFACTURER OF PICNIC SHELTER, PICNIC TABLE, PLAY EQUIPMENT, BENCHES, TRASH RECEPTACLES AND OTHER SITE FURNITURE.
9. CONTRACTOR SHALL LAY OUT / DRAW CHALK LINES FOR SAFETY ZONES OF ALL PLAY EQUIPMENT PRIOR TO INSTALLING ANY EQUIPMENT TO VERIFY CORRECT FIT OF PLAY EQUIPMENT WITHIN THE SAFETY SURFACING AREA.
10. CONTRACTOR SHALL LAY OUT CHALK LINES FOR ALL PATTERNS/COLORS OF THE RESILIENT MATTING SURFACING AS SHOWN IN THE DRAWING FOR APPROVAL BY THE PROJECT MANAGER.



City of Aurora
Parks, Recreation & Open Space Dept.
Date: October 2020

GENERAL NOTES --
LAYOUT

PROS
G-1.0

1. EXISTING CONTOUR INTERVAL IS 1 FOOT; PROPOSED CONTOUR INTERVAL IS 1 FOOT
2. CONTRACTOR SHALL USE WATER SPRINKLING AND OTHER SUITABLE METHODS TO LIMIT DUST AND DIRT SCATTERING WHEN REQUESTED BY OWNER. DO NOT USE WATER WHEN IT MAY CREATE HAZARDOUS CONDITIONS SUCH AS ICING, FLOODING OR RUNOFF POLLUTION OR IF PROHIBITED BY CURRENT DROUGHT RESTRICTIONS.
3. FILL SOIL, IF REQUIRED SHALL MEET THE REQUIREMENTS OUTLINED IN THE SPECIFICATIONS. (EARTHWORK SECTION 02200).
4. UTILITIES SHOWN ARE FOR INFORMATION ONLY. IT SHALL REMAIN THE CONTRACTOR'S RESPONSIBILITY TO LOCATE AND PROTECT ALL EXISTING UTILITIES. CONTRACTOR SHALL RESTORE AREAS DAMAGED DURING CONSTRUCTION TO THEIR ORIGINAL STATE. CONTACT THE COLORADO UTILITY NOTIFICATION CENTER BY CALLING 811. FOR IRRIGATION LINES, CONTACT THE PARKS & FORESTRY DIVISION OF PROS.
5. THE CONTRACTOR SHALL FIELD VERIFY EXISTING CONDITIONS AND BASE THE BID ON ACTUAL ON-SITE CONDITIONS AND MEASUREMENTS. POSITIVE DRAINAGE SHALL BE MAINTAINED AT ALL TIMES. ANY DISCREPANCIES ON THE PLANS SHALL BE BROUGHT TO THE IMMEDIATE ATTENTION OF THE PROJECT MANAGER.
6. SPOT ELEVATIONS TAKE PRECEDENCE OVER CONTOURS.
7. THE CONTRACTOR SHALL PROVIDE SMOOTH FINISH GRADE FREE OF RUTS, DEPRESSIONS AND IRREGULARITIES.
8. ALL WALKS AND PAVED AREAS SHALL BE GRADED TO INSURE POSITIVE DRAINAGE. FINISHED LANDSCAPE GRADE ADJACENT TO PAVEMENT OR CURB SHALL BE 1" BELOW TOP OF PAVEMENT OR CURB FOR IRRIGATED TURF AREAS AND FLUSH WITH TOP OF PAVEMENT OR CURB FOR NATIVE SEEDED OR MULCHED AREAS.
9. PROPOSED CONCRETE WALK TO MATCH GRADE OF EXISTING WALKS AND PAVED AREAS AT ALL INTERSECTIONS BETWEEN THE TWO.
10. ALL WALKS SHALL BE 5% SLOPE MAXIMUM WITH A 2% CROSS SLOPE MAXIMUM. ALL RAMPS SHALL BE 8.3% MAXIMUM. SLOPE ALL UNDERDRAINS AT 1% MINIMUM.
11. CONTRACTOR MUST OBTAIN NPDES STORMWATER DISCHARGE PERMIT FROM THE COLORADO DEPT. OF PUBLIC HEALTH AND ENVIRONMENT IF REQUIRED.
12. CONTRACTOR MUST OBTAIN THE REQUIRED CITY OF AURORA STORMWATER DISCHARGE PERMIT PRIOR TO ALL EARTHWORK OPERATIONS.
13. BENCHMARK: SHOWN OR DESCRIBED ON EACH GRADING PLAN SHEET; ESTABLISH TEMPORARY BENCHMARK ON SITE.



City of Aurora
Parks, Recreation & Open Space Dept.
Date: October 2020

GENERAL NOTES --
GRADING

PROS
G-2.0

IRRIGATION SYSTEM DESCRIPTION

Consultant to fill in

1. THE IRRIGATION DESIGN IS BASED UPON A MINIMUM DYNAMIC PRESSURE OF ?? PSI AND MAXIMUM DISCHARGE OF ?? GPM. CONTRACTOR SHALL VERIFY THESE PARAMETERS AT THE POINT OF CONNECTION PRIOR TO BEGINNING WORK AND SHALL REPORT DIFFERENCES TO THE PROJECT MANAGER.
Consultant to fill in
2. A FULLY AUTOMATIC SPRINKLER SYSTEM WILL IRRIGATE ALL TREES, SHRUBS, PERENNIALS, GROUNDCOVERS, AND TURF AREAS. POP-UP ROTORS AND SPRAY SPRINKLERS WILL IRRIGATE ALL PLANTED AREAS. .. *(consultant to modify if subsurface drip used)*
3. POTABLE / NON-POTABLE (*consultant to modify*) WATER WILL BE USED TO IRRIGATE THIS SITE.
4. POINT OF CONNECTION WILL BE *(consultant to describe location, size and type of connection.)*
5. QUICK COUPLING VALVES SHALL BE PROVIDED AT LOCATIONS INDICATED ON THE PLANS.



City of Aurora
Parks, Recreation & Open Space Dept.
Date: October 2020

IRRIGATION SYSTEM
DESCRIPTION

PROS
I-1.0

GENERAL IRRIGATION NOTES:

1. THE IRRIGATION CONTRACTOR SHALL INSTALL THE IRRIGATION SYSTEM IN ACCORDANCE WITH THE PLANS AND SPECIFICATIONS FOR THE IRRIGATION SYSTEM AND RELATED WORK.
2. THE IRRIGATION CONTRACTOR SHALL DETERMINE THE EXACT LOCATION OF ALL UTILITIES AND ELECTRICAL WIRING WITHIN THE SITE PRIOR TO BEGINNING WORK. LOCATIONS WHICH DIFFER FROM THOSE SHOWN ON THE PLANS SHALL BE REPORTED TO THE PROJECT MANAGER PRIOR TO WORK BEGINNING.
3. THE IRRIGATION CONTRACTOR SHALL NOT INSTALL THE SPRINKLER SYSTEM WHEN IT IS OBVIOUS IN THE FIELD THAT OBSTRUCTIONS OR GRADE DIFFERENCES EXIST THAT DIFFER FROM THOSE SHOWN ON THE PLANS OR WHEN DISCREPANCIES IN CONSTRUCTION DETAILS, LEGENDS, NOTES OR SPECIFICATIONS ARE DISCOVERED. ALL SUCH OBSTRUCTIONS AND DISCREPANCIES SHALL BE IMMEDIATELY REPORTED TO THE PROJECT MANAGER.
4. THE DRAWINGS ARE DIAGRAMMATIC. ELEMENTS ARE SHOWN IN APPROXIMATE LOCATION ONLY.
5. THE IRRIGATION CONTRACTOR SHALL ADJUST NOZZLES FOR SPRAY SPRINKLERS TO PROVIDE COMPLETE COVERAGE WITH MINIMUM OVERSPRAY FOR THE SITE CONDITIONS.
6. FOR PVC PIPE LESS THAN 2-1/2" DIAMETER, USE SOLVENT WELD JOINTS. PVC PIPE 2-1/2" DIAMETER AND LARGER SHALL BE GASKET JOINT PIPE.
7. IF CONDITIONS DO NOT ALLOW STRICT CONFORMANCE TO THE NOTES, DETAILS AND SPECIFICATIONS, THE CONTRACTOR SHALL REQUEST APPROVAL FROM THE CITY OF AURORA PROJECT MANAGER OR PROJECT SUPERVISOR BEFORE PERFORMING WORK IN AN ALTERNATIVE MANNER.
8. MECHANICAL JOINT FITTINGS AND JOINT RESTRAINED FITTINGS SHALL BE SPRAYED WITH AUTOMOTIVE UNDERCOATING AND WRAPPED WITH 8 MIL PLASTIC PRIOR TO INSTALLATION OF THRUST BLOCKS AND BACKFILL.

GENERAL ELECTRICAL NOTES

1. CONNECTION TO ELECTRICITY: *(consultant to describe where, how and type of connection)*
2. CONTRACTOR SHALL CONNECT POWER TO EXTERIOR DISCONNECT AT CONTROLLER. CONTRACTOR RESPONSIBLE FOR ALL FEES, PERMITS, AND COORDINATION WITH XCEL POWER COMPANY.
3. CONTRACTOR SHALL SUPPLY AND INSTALL ONE CONTROLLER ENCLOSURE PER DETAIL AT EACH CONTROLLER LOCATION. EXACT LOCATION SHALL BE APPROVED BY THE PROJECT MANAGER PRIOR TO INSTALLATION.
4. FOR ADDITIONAL REQUIREMENTS, SEE TRENCHING DETAIL, WIRING TABLE AND WIRING NOTES.



City of Aurora
Parks, Recreation & Open Space Dept.
Date: October 2020

IRRIGATION
NOTES

PROS
I-1.1

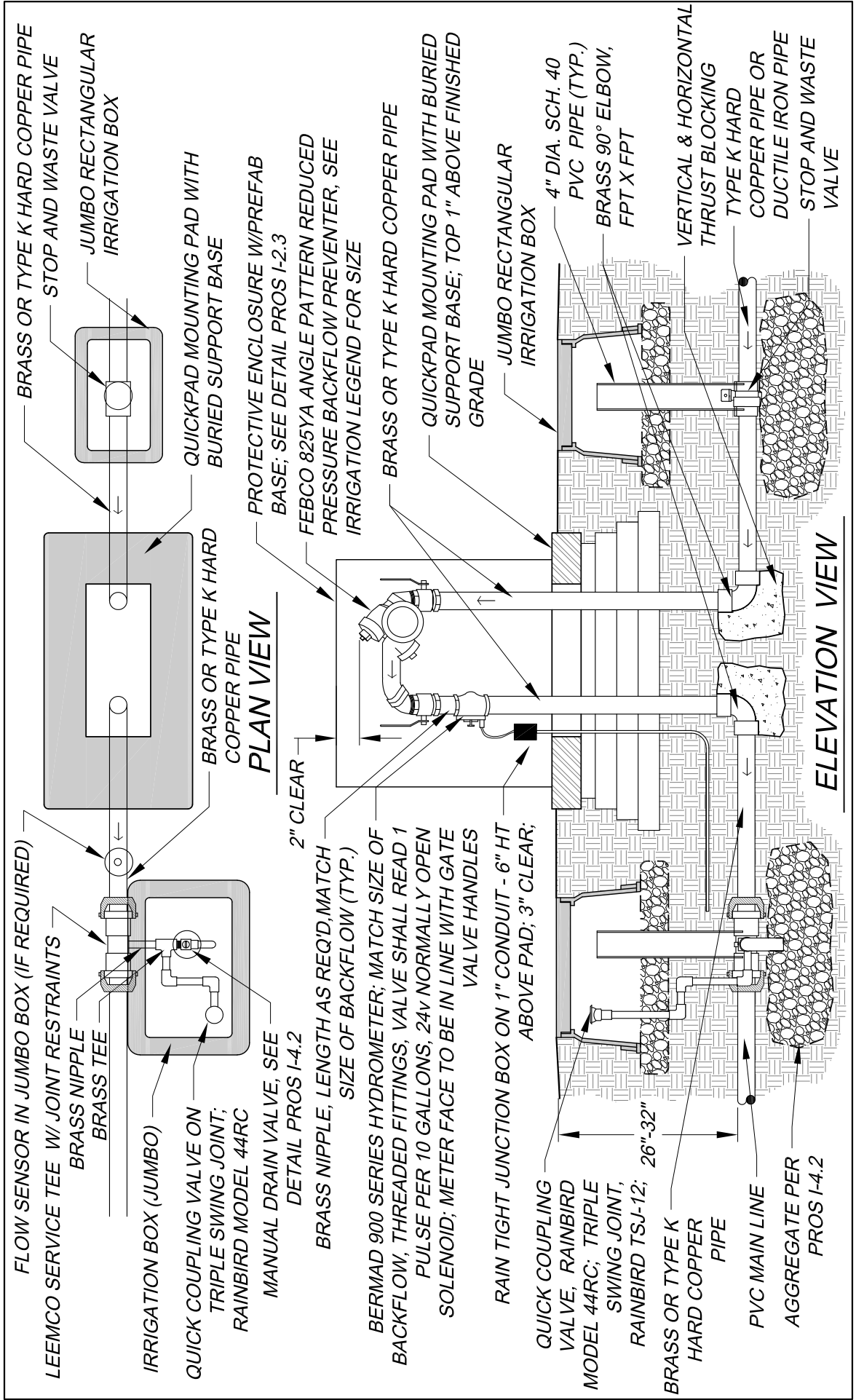



**PROS
I-2.1**

**BACKFLOW PREVENTER
2" & SMALLER**

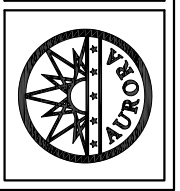
City of Aurora
Parks, Recreation & Open Space Dept.
Date: October 2020

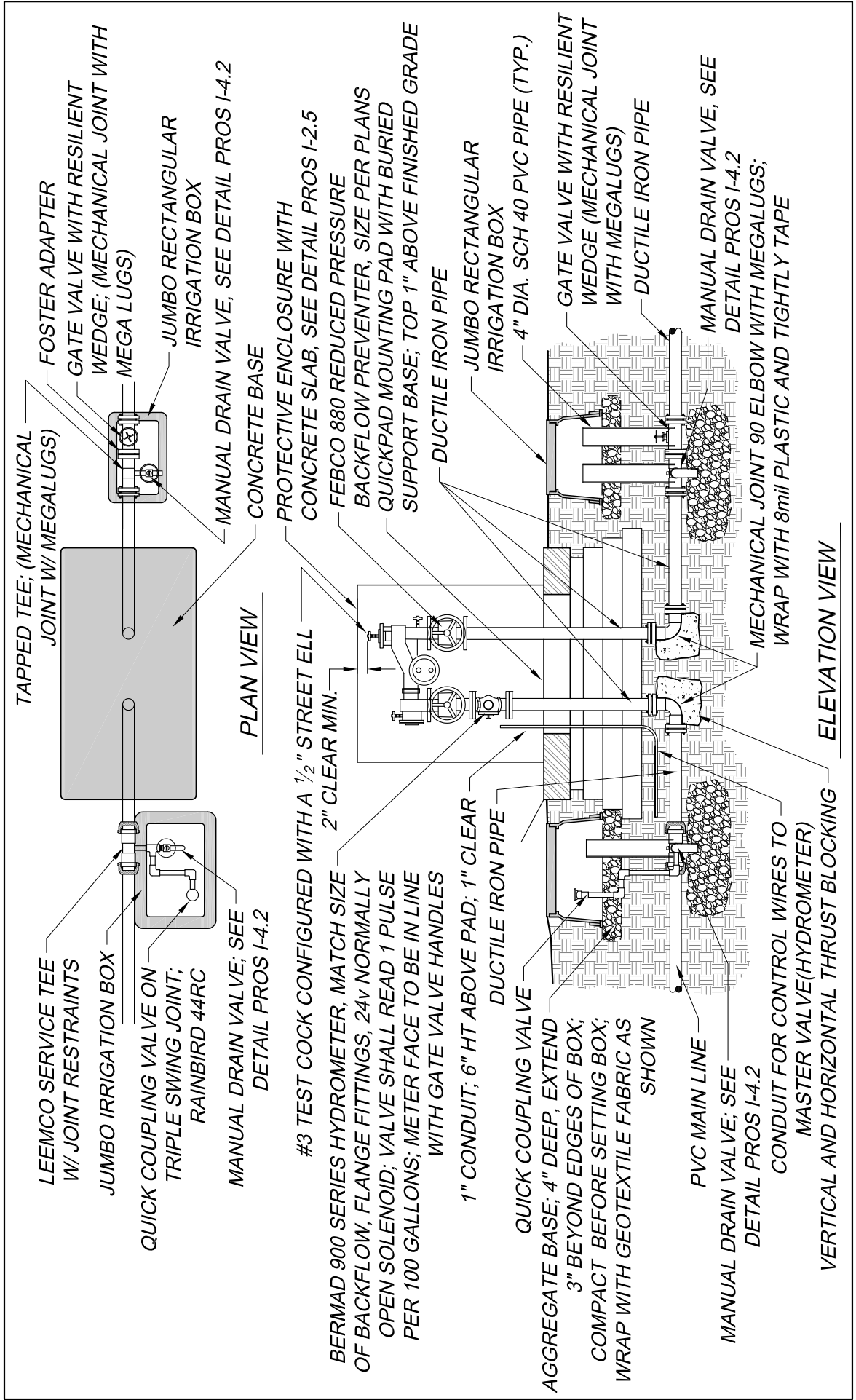



	<p>City of Aurora Parks, Recreation & Open Space Dept. Date: October 2020</p>	<p>BACKFLOW PREVENTER 2-1/2" & larger</p>	<p>PROS I-2.2</p>
---	---	--	-------------------------------------

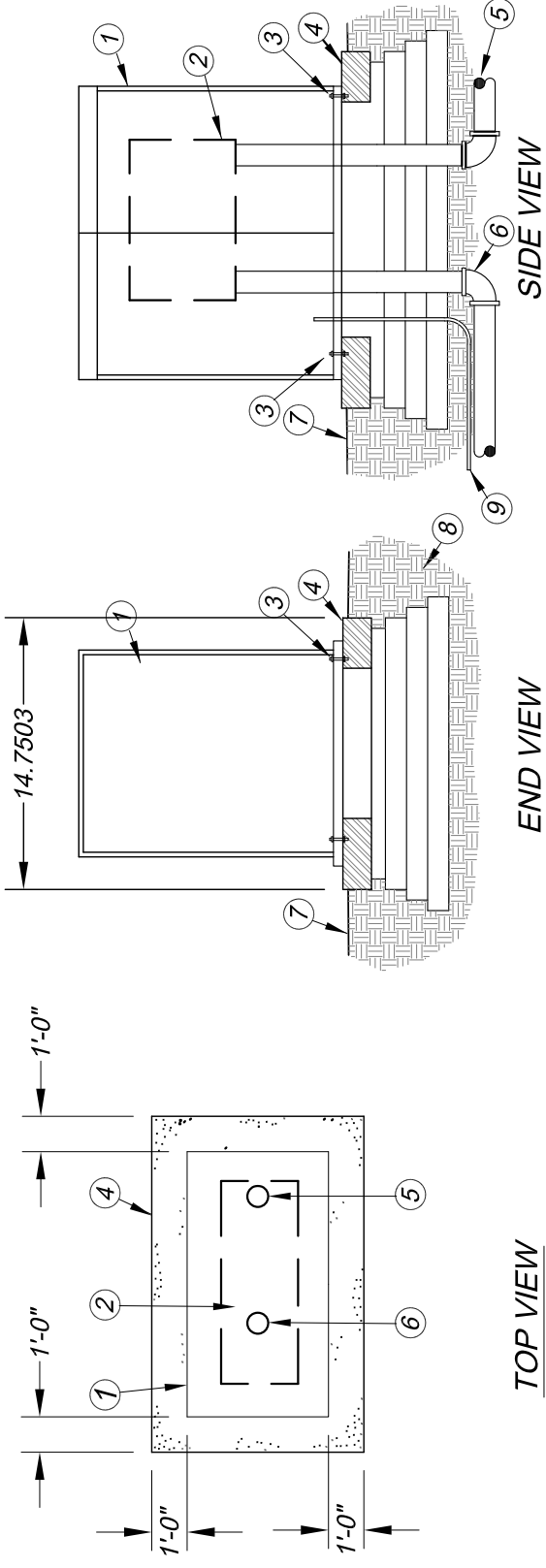

TOP VIEW

END VIEW

SIDE VIEW

NOTES

1. BACKFLOW ENCLOSURE. STRONGBOX MODEL NO. SBBC-___ALHP SIZE AS REQUIRED TO ENCLOSE PROPOSED BACKFLOW DEVICE
2. BACKFLOW PREVENTER.
3. QUICKPAD FASTENING BRACKET
4. QUICKPAD MOUNTING PAD WITH BURIED SUPPORT BASE; TOP 1" ABOVE FINISH GRADE

5. WATER SERVICE INLET PIPING.
6. WATER SERVICE OUTLET PIPING.
7. FINISH GRADE.
8. SUBGRADE COMPACTED TO 95% OF STANDARD PROCTOR DENSITY
9. 1" DIA. GREY PVC CONDUIT FOR HYDROMETER WIRES; 6" HT ABOVE BASE, 3" CLEAR FROM PIPES



City of Aurora
 Parks, Recreation & Open Space Dept.
 Date: October 2020

BACKFLOW ENCLOSURE

**PROS
 I-2.4**

NOTES:

1. LAYOUT OF COMPONENTS WITHIN ENCLOSURE TO BE APPROVED BY PROJECT MANAGER PRIOR TO INSTALLATION.
2. SEAL ALL CONDUITS AND SWEEPS WITH EXPANDING FOAM.
3. INSTALL ALL SWEEP WITH 3" ABOVE TOP OF QUICK PAD.

STRONGBOX ENCLOSURE SB-24-SS WITH 12" PEDESTAL AND QUICKPAD, UNLESS SPECIFIED OTHERWISE IN IRRIGATION LEGEND

EXHAUST FAN MOUNTED AT VENT IN STRONGBOX
THERMOSTAT; WIRE TO POWER IN DUPLEX BOX
GROUND FAULT PROTECTED DUPLEX BOX W/ 120V RECEPTACLE & SWITCH; SWITCH AND GFI AMPS TO MATCH BREAKER; ADDITIONAL SURGE PROTECTION AS SPECIFIED

ALL CONDUITS SHALL EXTEND 3" ABOVE TOP OF CONCRETE

CONCRETE PAD; 6" THICK; 12" LONGER AND WIDER THAN ENCLOSURE

FINISH GRADE

1" SCH. 40 PVC SWEEP ELL FOR WIRES TO MASTER VALVE

2" SCH. 40 PVC SWEEP ELL FOR CONTROL WIRES AND FLOW SENSOR WIRES (QUANTITY AS REQUIRED)

SPARE SWEEP, 2" SCH. 40

1/2" SCH. 40 PVC SWEEP FOR GROUND WIRE

CONTROLLER INSTALLED BY CONTRACTOR; SEE IRRIGATION LEGEND
RAIN-CLIK RAIN SENSOR PROVIDED AND INSTALLED BY CONTRACTOR IF REQUIRED ON LEGEND

TRANSFORMER; ALL CONNECTIONS TO BE PLACED WITHIN A JUNCTION BOX
MOUNTING POLE WITH BASE PLATE, IF REQUIRED ON LEGEND; SCH 40, 1-1/2" DIA. GALV. PIPE.

6 GA. SOLID COPPER GROUNDING WIRE MOUNTED DIRECTLY TO BACKBOARD AND ATTACHED TO GROUNDING ROD

14" x 14" x 24" DEEP CONCRETE PAD IF POLE / PAD REQUIRED ON LEGEND; SLOPE AT 1-2% AWAY FROM CONTROLLER; EMBED ANCHOR BOLTS

5/8" x 8' COPPER-CLAD GROUNDING ROD WITH BRONZE CLAMP

1" SCH 80 PVC SWEEP ELL FOR 120V ELECTRICAL SERVICE; FLEXIBLE CONDUIT FROM ELL TO JUNCTION BOX OR SERVICE PANEL

ATTACH TO IRRIGATION GROUNDING KIT #IRRGRDKIT2 BY HARGER. INSTALL PER MANUFACTURER'S INSTRUCTIONS. MINIMUM RESISTANCE SHALL BE 10 OHMS.

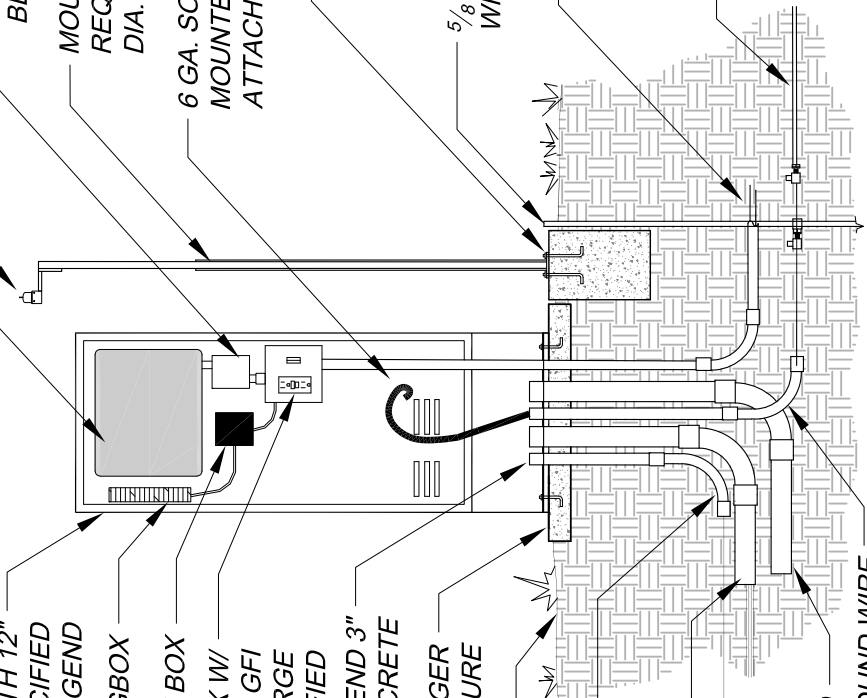

City of Aurora
Parks, Recreation & Open Space Dept.
Date: October 2020

ELECTRIC CONTROLLER
(with Harger grounding mat)

PROS
I-2.5

WIRING NOTES & TABLE

- CONTRACTOR SHALL INSTALL ONE(1) SPARE COMMON WIRE FROM THE CONTROLLER ALONG THE ENTIRE LENGTH IF THE MAIN LINE. FOR EACH 16 STATIONS IN THE CONTROLLER, THE CONTRACTOR SHALL INSTALL THREE(3) SPARE VALVE WIRES FROM THE CONTROLLER ALONG THE ENTIRE LENGTH OF THE MAIN LINE, UP TO A MAXIMUM OF NINE(9) SPARE WIRES. AT EACH CONTROL VALVE BOX, MAKE THREE (3) SPARE VALVE WIRES AND ONE (1) SPARE COMMON WIRE ACCESSIBLE BY LOOPING AND TAPING IN THE VALVE BOX.
- SPARE WIRES ARE NOT FOR THE CONTRACTOR'S USE DURING CONSTRUCTION AND SHALL BE AVAILABLE FOR CITY USE AT THE COMPLETION OF THE PROJECT. CONTRACTOR SHALL INSTALL ADDITIONAL SPARE WIRES FOR THEIR USE DURING CONSTRUCTION.
- AT ENDS OF MAIN LINE, LOOP AND TAPE ALL SPARE WIRES. COVER ENDS OF WIRE WITH 3M DBYR CONNECTORS. PLACE LOOPS IN VALVE BOXES.
- COMMON WIRES (AND SPARE COMMON WIRES) SHALL BE 12g. ALL OTHER WIRES SHALL BE 14g IF LESS THAN 2500 FEET LONG AND 12g IF LONGER.
- INSTALL ONE 14g TRACER WIRE ALONG THE ENTIRE LENGTH OF MAIN LINE AND LOOP ONLY AT SPLICE BOXES.
- FOR ADDITIONAL REQUIREMENTS, SEE TRENCHING DETAIL.

WIRE COLORS	
USE	COLOR
MASTER VALVE	PURPLE *
ZONE VALVE	RED
COMMON	WHITE
SPARE COMMON	YELLOW
SPARES FOR ZONE VALVES	GREEN
SENSOR (PART OF MASTER VALVE)	ORANGE * & BLUE*
TRACER WIRE	BROWN
EXTRAS FOR CONTRACTOR'S USE	BLACK

* PROVIDE 2 OF THESE COLORS



City of Aurora
Parks, Recreation and Open Space Dept.
Date: October 2020

WIRING NOTES
& TABLE

PROS
I-3.0

MAIN & WIRING

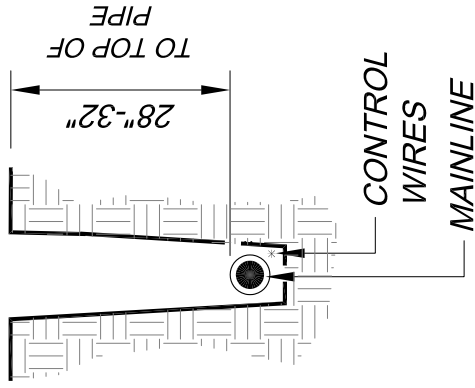

LATERAL

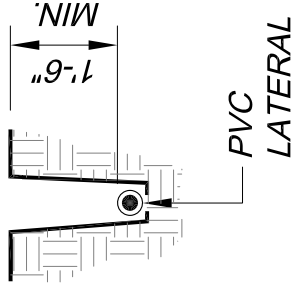

120 VOLT

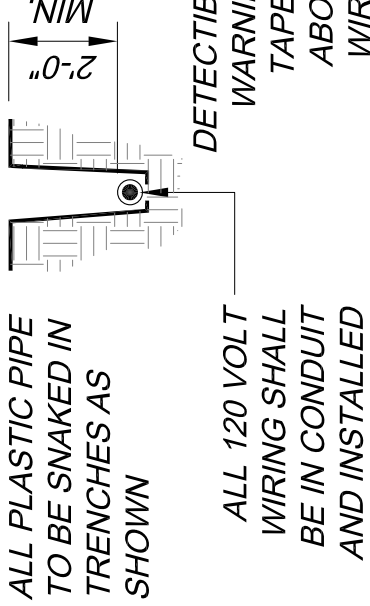

CONTROL WIRING

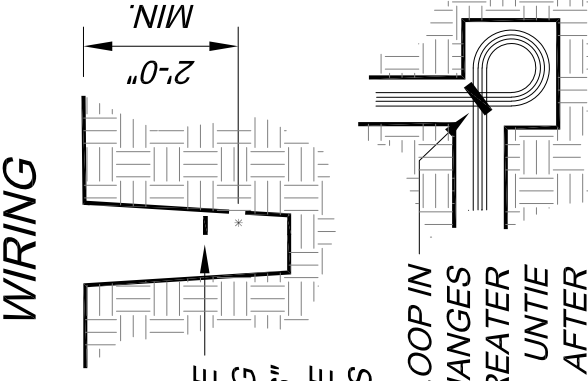

ALL PLASTIC PIPE TO BE SNAKED IN TRENCHES AS SHOWN

ALL 120 VOLT WIRING SHALL BE IN CONDUIT AND INSTALLED IN ACCORDANCE WITH LOCAL CODES

DETECTIBLE WARNING TAPE 6" ABOVE WIRES

TIE A LOOSE 20" LOOP IN ALL WIRING AT CHANGES OF DIRECTION OF GREATER THAN 30 DEGREES. UNTIE ALL LOOPS AFTER CONNECTIONS HAVE BEEN MADE.

NOTES

1. MAXIMUM DEPTH SHALL NOT EXCEED INDICATED MINIMUM DEPTHS BY MORE THAN 6 INCHES WITHOUT THE APPROVAL OF THE PROJECT MANAGER.
2. THE CONTRACTOR SHALL NOT RUN ANY TWO (2) PIPES IN THE SAME TRENCH EXCEPT AT SLEEVE LOCATIONS. THIS INCLUDES "PIGGYBACKING" PIPE AND RUNNING PIPE SIDE BY SIDE IN THE SAME TRENCH.
3. IN TRENCHES, BUNDLE AND TAPE WIRES AT 20' MIN. INTERVALS.
4. FOR ADDITIONAL REQUIREMENTS, SEE WIRING TABLE AND WIRING NOTES.



City of Aurora
 Parks, Recreation & Open Space Dept.
 Date: October 2020

TRENCHING

PROS
I-3.1

NOTES:

1. SEE PLANS FOR SLEEVE LOCATIONS.
2. ALL SLEEVES SHALL EXTEND 12" BEYOND ANY FLATWORK OR CURBS SHOWN ON PLANS, 10' BEYOND MEDIAN CURBS.
3. COVER ENDS OF EMPTY SLEEVES WITH CAP OR TAPE PRIOR TO BACKFILLING.
4. MARK EACH SLEEVE END WITH A METAL T-POST EXTENDING 2' ABOVE FINISHED GRADE AND PAINTED ORANGE.
5. INSTALL A 1/4" NYLON PULL CORD EXTENDING THE ENTIRE LENGTH OF THE SLEEVE.
6. INSTALL 1 PVC SLEEVE FOR MAINLINE AND 1 FOR ELECTRICAL WIRING AS SHOWN.
7. LOCATION OF SLEEVING ON PLANS IS DIAGRAMMATIC AND MAY DIFFER DUE TO ACTUAL FIELD CONDITIONS. SLEEVES ARE SIDE BY SIDE IN SAME TRENCH AS PER DETAIL.
8. IF SLEEVES INSTALLED BY BORING, THE MAIN SLEEVE SHALL BE LARGE ENOUGH TO CONTAIN TWO SMALLER SLEEVES MEETING THE SIZE REQUIREMENTS FOR THE MAINLINE AND CONTROL WIRE SLEEVES.
9. PERMANENTLY MARK CURB OR PAVEMENT BY SAWCUTTING OR SCORING AN "X" IN THE CONCRETE AT THE LOCATION OF EACH SLEEVE.
10. EXTEND SLEEVING A MINIMUM OF 1'-0" BEYOND FLATWORK OR BACK OF CURB; BEVEL EDGES OF PIPE AND REMOVE SHARP EDGES; COVER EDGES WITH DUCT TAPE.
11. IF SLEEVE IS UNUSED, SEAL ENDS OF SLEEVE WITH GEOTEXTILE FABRIC AND/OR TAPE
12. IF SLEEVE IS USED, SEAL THE UNUSED PORTION OF THE SLEEVE WITH GEOTEXTILE FABRIC AND/OR TAPE.

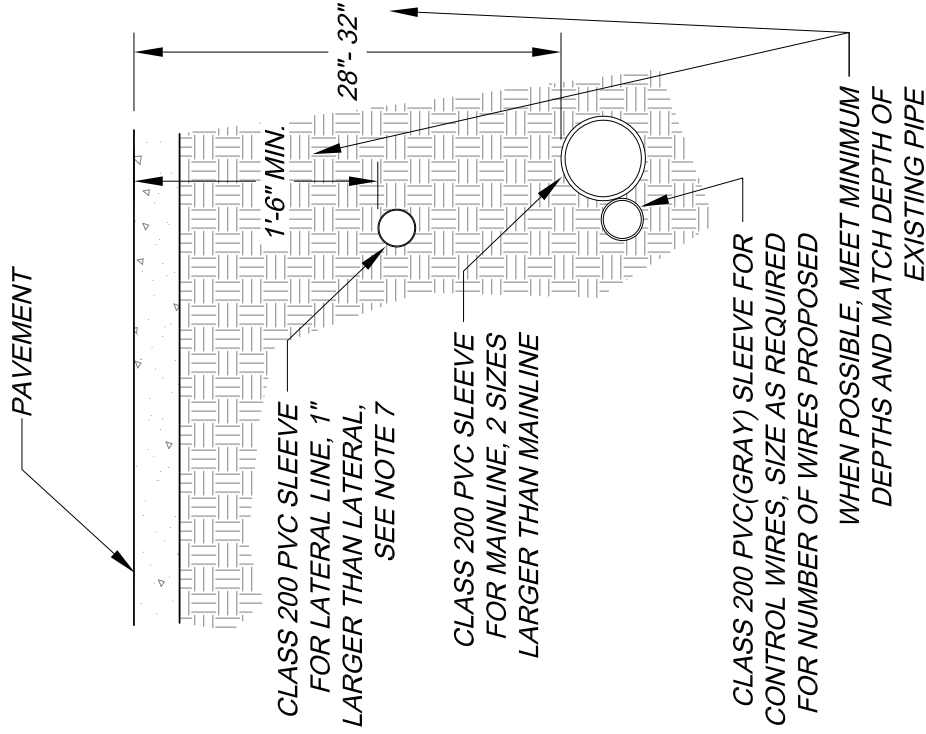

City of Aurora
 Parks, Recreation and Open Space Dept.
 Date: October 2020

IRRIGATION SLEEVING

**PROS
 I-3.2**

RESTRAINT REQUIREMENTS FOR STRAIGHT METAL PIPE JOINTS

(all straights joints, within the distance given below, shall have restraints)

PIPE SIZE	DEGREE OF BEND			STEP REDUCTION*			DEAD ENDS & GATE VALVES	
	11	22	45	90	1	2		3
2"	1'	1'	2'	6'				19'
2.5"	1'	2'	4'	9'	4'			23'
3"	2'	3'	6'	11'	8'	10'		30'
4"	2'	4'	9'	20'	14'	20'	31'	45'
6	3'	6'	13'	29'	30'	40'	53'	63'
8"	4'	8'	15'	38'	33'	55'	63'	75'

*1 step equals one pipe size reduction (e.g. 8" to 6")

2 step equals two pipe size reduction (e.g. 6" to 3")

JOINT RESTRAINT NOTES:

1. ALL METAL JOINTS INVOLVING BENDS, REDUCTIONS, GATE VALVES AND ENDS SHALL HAVE RESTRAINTS.
2. ALL MAINLINE IS TO BE INSTALLED & TESTED ACCORDING TO MANUFACTURER'S INSTALLATION INSTRUCTIONS WHICH SHALL BE A PART OF THESE SPECIFICATIONS.
3. ALL TRENCH DEPTHS & WIDTHS SHALL BE AS SHOWN IN THE SPECIFICATIONS & DETAILS.

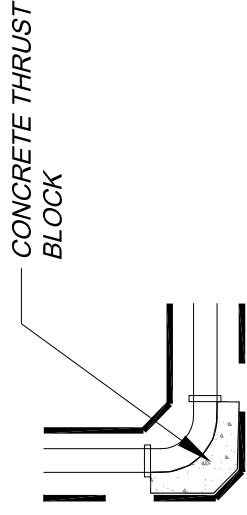

THRUST BLOCKING

(Install only at backflow preventer)

THRUST BLOCKING NOTES:

1. PRIOR TO POURING THRUST BLOCKS, SPRAY RESTRAINT BOLTS WITH VEHICLE UNDERCOATING AND WRAP DUCTILE IRON FITTINGS WITH 8 MIL THICK POLYWRAP.
2. FILL VOID BETWEEN PIPE AND UNDISTURBED SUBGRADE.
3. CONCRETE TO BE A MINIMUM THICKNESS OF 4" IN EVERY DIMENSION. OVEREXCAVATE AS REQUIRED.



City of Aurora
Parks, Recreation & Open Space Dept.
Date: October 2020

THRUST BLOCKING & JOINT RESTRAINTS

PROS I-3.4

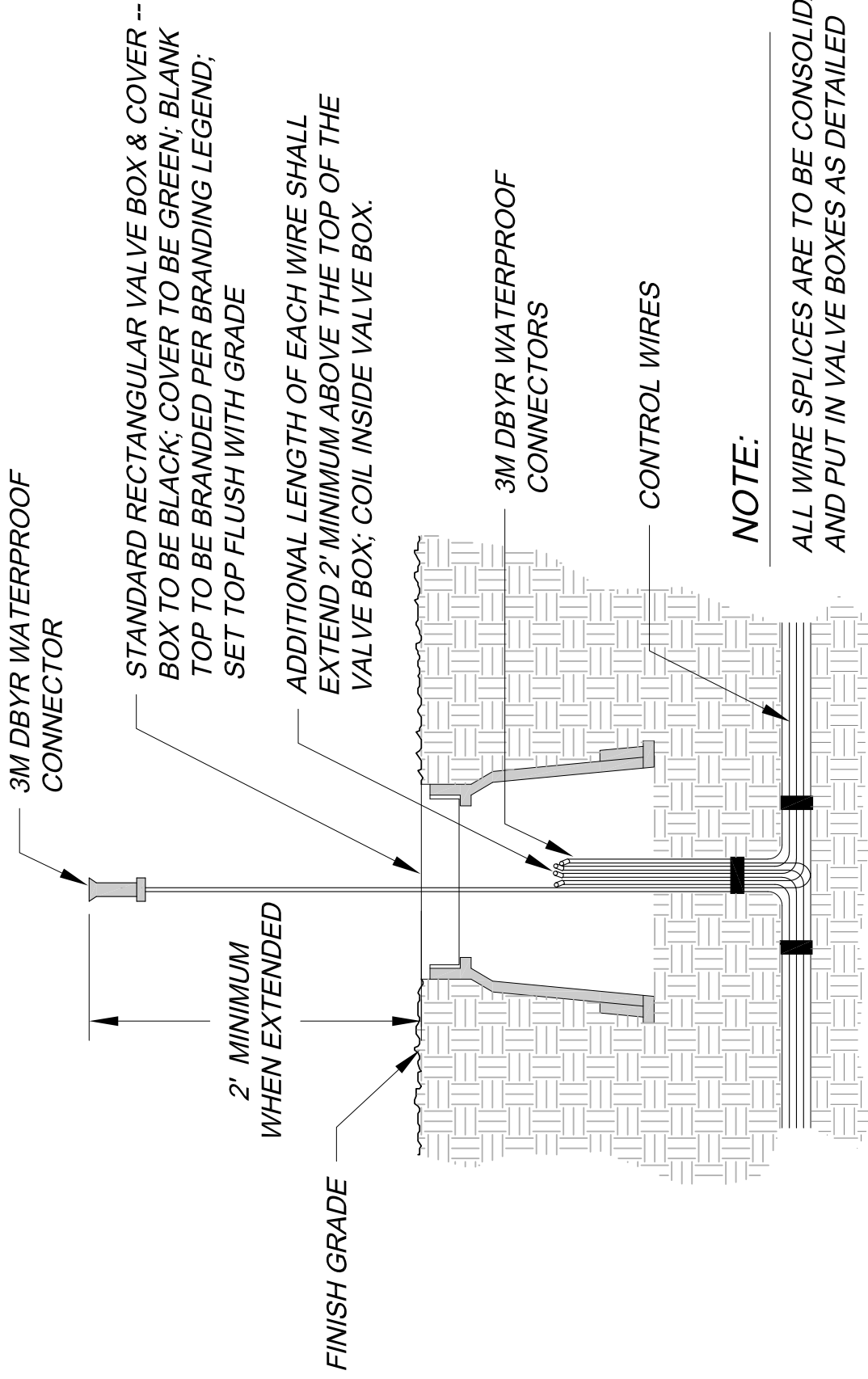

City of Aurora
 Parks, Recreation & Open Space Dept.
 Date: October 2020

PROS
I-3.5

WIRE
SPLICES



WIRING NOTES & TABLE

1. MASTER VALVE, 2-WIRE PATH AND SENSOR WIRES SHALL BE 14 AWG/2.08 mm SOLID COPPER, TWISTED WIRE PAIR, JACKETED
2. ALL OTHER WIRES SHALL BE 14 AWG/1 mm SOLID COPPER, JACKETED
3. FOR ADDITIONAL REQUIREMENTS, SEE TRENCHING DETAIL.

WIRE COLORS	
USE	COLOR
CONTROLLER TO MASTER VALVE	PURPLE
CONTROLLER TO FURTHEST ZONE VALVE (i.e. 2-wire path)	RED
DECODER TO SOLENOIDS	YELLOW
TO GROUNDING ROD / MAT	GREEN
CONTROLLER TO SENSOR	ORANGE
TRACER WIRE	BROWN
EXTRAS FOR CONTRACTOR'S USE	N/A

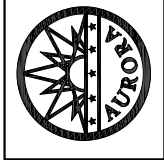

City of Aurora
 Parks, Recreation and Open Space Dept.
 Date: October 2020

WIRING NOTES
 & TABLE - 2 WIRE SYSTEM

PROS
I-3.6

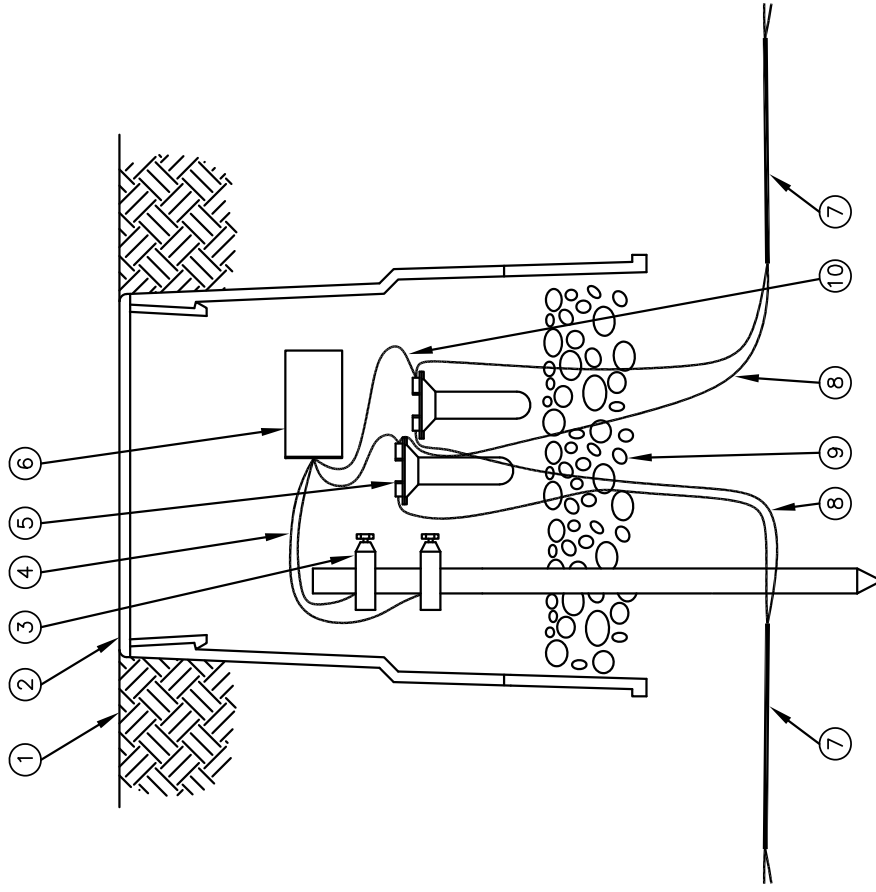

1. FINISH GRADE OR TOP OF MULCH
2. 10-INCH VALVE BOX WITH COVER:
3. GROUNDING ROD: 10 OHMS OR LESS
4. WIRE FROM LINE SURGE PROTECTOR TO
5. GROUNDING ROD BRASS CLAMPS (1 OF 2)
6. DB SERIES WIRE CONNECTOR:
7. LINE SURGE ARRESTOR TO BE COMPATIBLE WITH DECODER AND CONTROLLER
8. TWO-WIRE CABLE TO NEXT DEVICE (FIELD DECODER, SENSOR DECODER, LINE SURGE ARRESTOR OR CONTROLLER)
9. COMMUNICATION WIRE TO NEXT DEVICE (FIELD DECODER, SENSOR DECODER, LINE SURGE ARRESTOR OR CONTROLLER)
10. 3-INCH MINIMUM DEPTH OF 3/4-INCH WASHED GRAVEL

NOTES:

1. EVERY 300 FEET, TEE OFF FROM WIRE ALIGNMENT AND INSTALL A LINE SURGE ARRESTOR W/ GROUNDING ROD 8' FROM WIRE ALIGNMENT. ALSO INSTALL A LINE SURGE ARRESTOR W/ GROUNDING ROD AT END OF WIRE RUN THAT TERMINATES IN THE FIELD.
2. SURGE ARRESTOR AND GROUNDING ROD CAN BE LOCATED WITHIN THE REMOTE CONTROL VALVE BOX

City of Aurora
 Parks, Recreation and Open Space Dept.
 Date: October 2020



**LINE SURGE ARRESTOR
 W/ GROUNDING ROD**

**PROS
 I-3.7**

STANDARD RECTANGULAR VALVE BOX, TOP TO BE T-TOP, GREEN FOR POTABLE SYSTEM, PURPLE FOR NON-POTABLE SYSTEM. BLANK COVER TO BE BRANDED PER BRANDING LEGEND. SET TOP OF COVER FLUSH WITH GRADE.

AGGREGATE BASE, 4" DEEP MIN., EXTEND 3" BEYOND EDGES OF BOX, COMPACT BEFORE SETTING BOX; ENCASE WITH GEOTEXTILE FABRIC

SCH 40 PVC PIPE, 6" DIA., EXTEND 3" ABOVE SURFACE OF COMPACTED AGGREGATE. PROVIDE 3" CLEARANCE BETWEEN TOP OF PIPE AND BOTTOM OF VALVE BOX LID. SET PIPE IN SHROUD AROUND 2" OPERATING NUT.

LEEMCO SELF-RESTRAINED GATE VALVE WITH RESILIENT WEDGE, SPIGOT x BELL, SQUARE NUT OPERATED, SIZE TO MATCH MAIN LINE

LEEMCO SELF-RESTRAINED "T" ON MAIN LINE, BELL x BELL x BELL, SIZE TO MATCH MAIN LINE

NOTE

IF ISOLATION VALVE IS SHOWN NOT ADJACENT TO A LEEMCO "T", CONSULT PROJECT MANAGER FOR INSTALLATION REQUIREMENTS

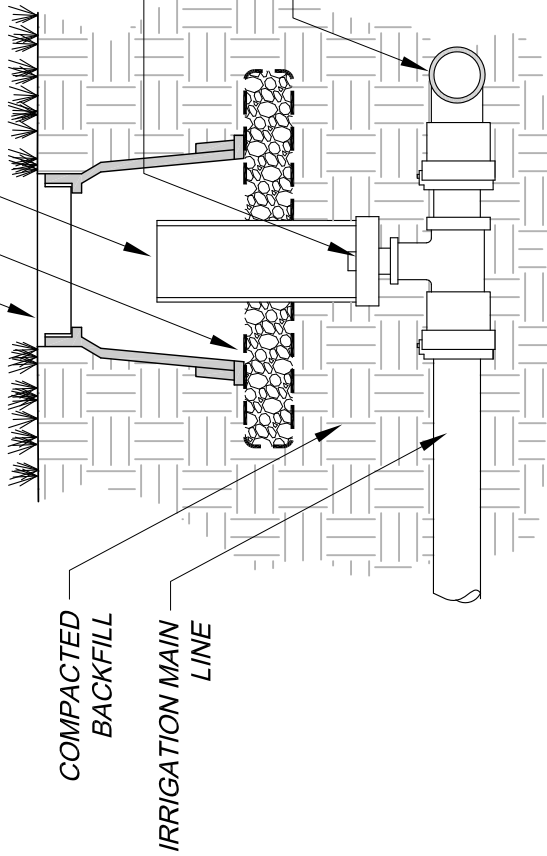

COMPACTED BACKFILL

IRRIGATION MAIN LINE



City of Aurora
Parks, Recreation & Open Space Dept.
Date: October 2020

ISOLATION VALVE

PROS I-4.0

NOTES:

1. CONTRACTOR SHALL CONSTRUCT ONE VALVE ASSEMBLY FOR INSPECTION AND APPROVAL PRIOR TO PROCEEDING WITH OTHER VALVE INSTALLATIONS
2. SPARE WIRES SHALL BE LOOPED AND ACCESSIBLE AT EACH VALVE (PER WIRING NOTES)
3. VALVE TO BE EQUIPPED WITH PRESSURE REGULATOR EXCEPT FOR DRIP ZONES

- PVC SCH. 80 NIPPLE
- PVC SCH. 80 UNION, FPT x FPT
- PVC SCH. 40 MALE ADAPTER
- CUT NOTCH IN BOX FOR LATERAL; 1" CLEARANCE

CLASS 200 PVC LATERAL: SIZE TO MATCH VALVE

28"-32"
1'-6"
135°

2" MIN. CLEAR

PLAN VIEW

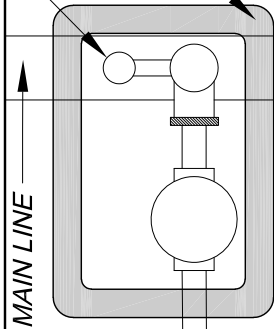

ELECTRIC REMOTE CONTROL VALVE; SEE IRRIGATION LEGEND AND PLANS FOR SIZE AND TYPE

- QUICK COUPLING VALVE -- ATTACH TO LEEMCO ANGLE VALVE CONNECTION WITH BRASS STREET 90 AND 1" X CLOSE BRASS NIPPLE WHEN SHOWN ON PLANS
- JUMBO RECTANGULAR BLACK VALVE BOX; TOP TO BE T-TOP, GREEN FOR POTABLE SYSTEMS, PURPLE FOR NON-POTABLE SYSTEMS; BLANK COVER TO BE BRANDED PER BRANDING LEGEND; SET TOP OF COVER FLUSH WITH GRADE; USE 3" OR 6" EXTENSION IF NEEDED.
- QUICK COUPLING VALVE (SEE PLANS)
- LEEMCO LV-218 ANGLE VALVE CONNECTION WITH LMN ADAPTER (SPIGOT x MPT, SIZE TO MATCH VALVE SIZE) AT OUTLET; USE EXTENSION WHEN NEEDED

SECTION

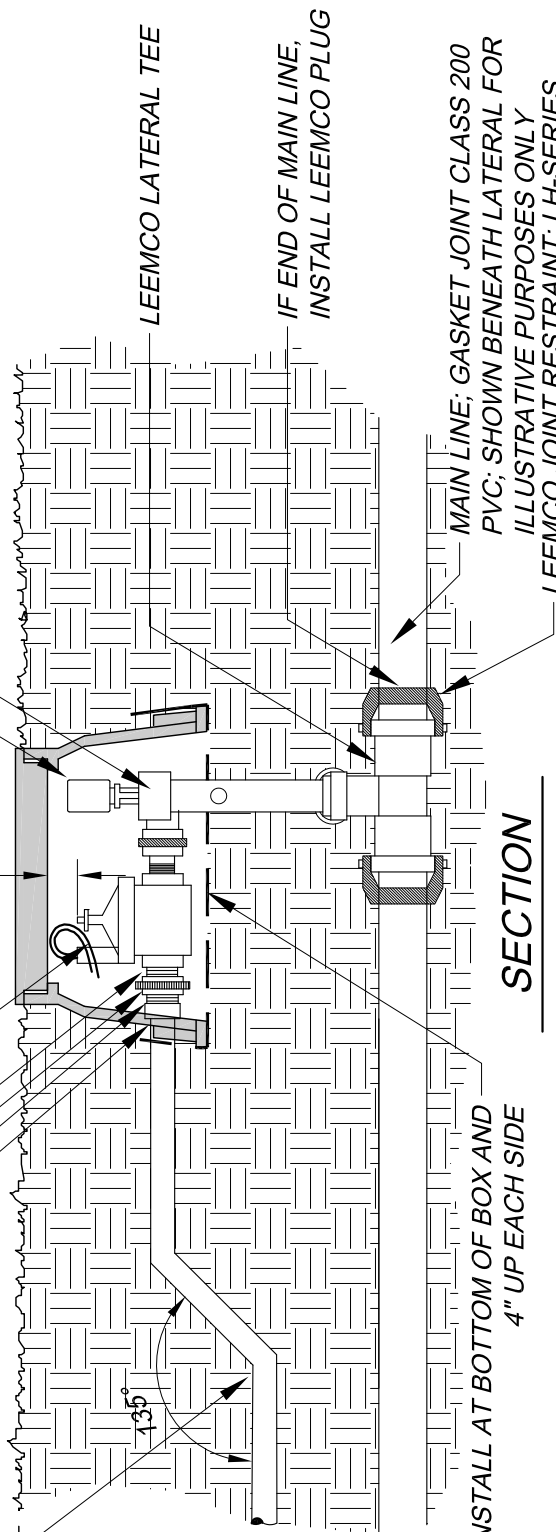

GEOTEXTILE FABRIC - INSTALL AT BOTTOM OF BOX AND 4" UP EACH SIDE

- LEEMCO LATERAL TEE
- IF END OF MAIN LINE, INSTALL LEEMCO PLUG
- MAIN LINE; GASKET JOINT CLASS 200 PVC; SHOWN BENEATH LATERAL FOR ILLUSTRATIVE PURPOSES ONLY
- LEEMCO JOINT RESTRAINT; LH-SERIES



City of Aurora
Parks, Recreation & Open Space Dept.
Date: October 2020

ELECTRIC REMOTE CONTROL VALVE

PROS I-4.1

STANDARD RECTANGULAR VALVE BOX. TOP TO BE T-TOP,
 GREEN FOR POTABLE SYSTEM, PURPLE FOR NON-POTABLE SYSTEM.
 BLANK COVER TO BE BRANDED PER BRANDING LEGEND. SET
 TOP OF COVER FLUSH WITH GRADE.

SCH. 40 PVC PIPE, 4" DIA., EXTEND 3" ABOVE SURFACE
 OF COMPACTED AGGREGATE. PROVIDE 3" CLEAR
 BETWEEN TOP OF PIPE AND BOTTOM OF VALVE BOX
 LID. CUT OUT OPENINGS FOR PIPE AND SET
 PIPE OVER VALVE.

1" CURB STOP VALVE (BRASS); FPT X MPT
 LEEMCO SERVICE "T" ON MAIN LINE
 WITH LH SERIES JOINT RESTRAINTS
 REQUIRED

1" x 4" BRASS NIPPLE

3' x 3' x 1' DEEP SUMP; WASHED GRAVEL OR RIVER
 ROCK, $\frac{3}{4}$ " TO 1-1/2" DIA.; ENCASE IN GEOTEXTILE
 FABRIC

COMPACTED
 SUBGRADE

GEOTEXTILE FABRIC -
 INSTALL AT BOTTOM OF BOX
 AND 4" UP EACH SIDE

SCH 40 PVC PIPE AND
 FITTINGS DOWNSTREAM
 OF VALVE

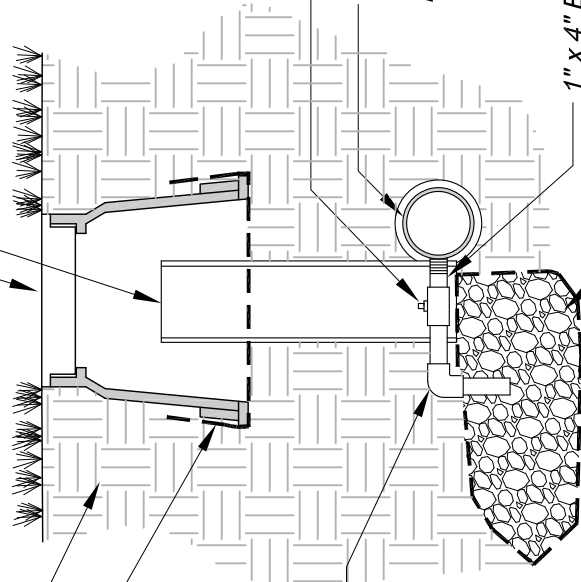

City of Aurora
 Parks, Recreation & Open Space Dept.
 Date: October 2020



MANUAL DRAIN VALVE

PROS
I-4.2

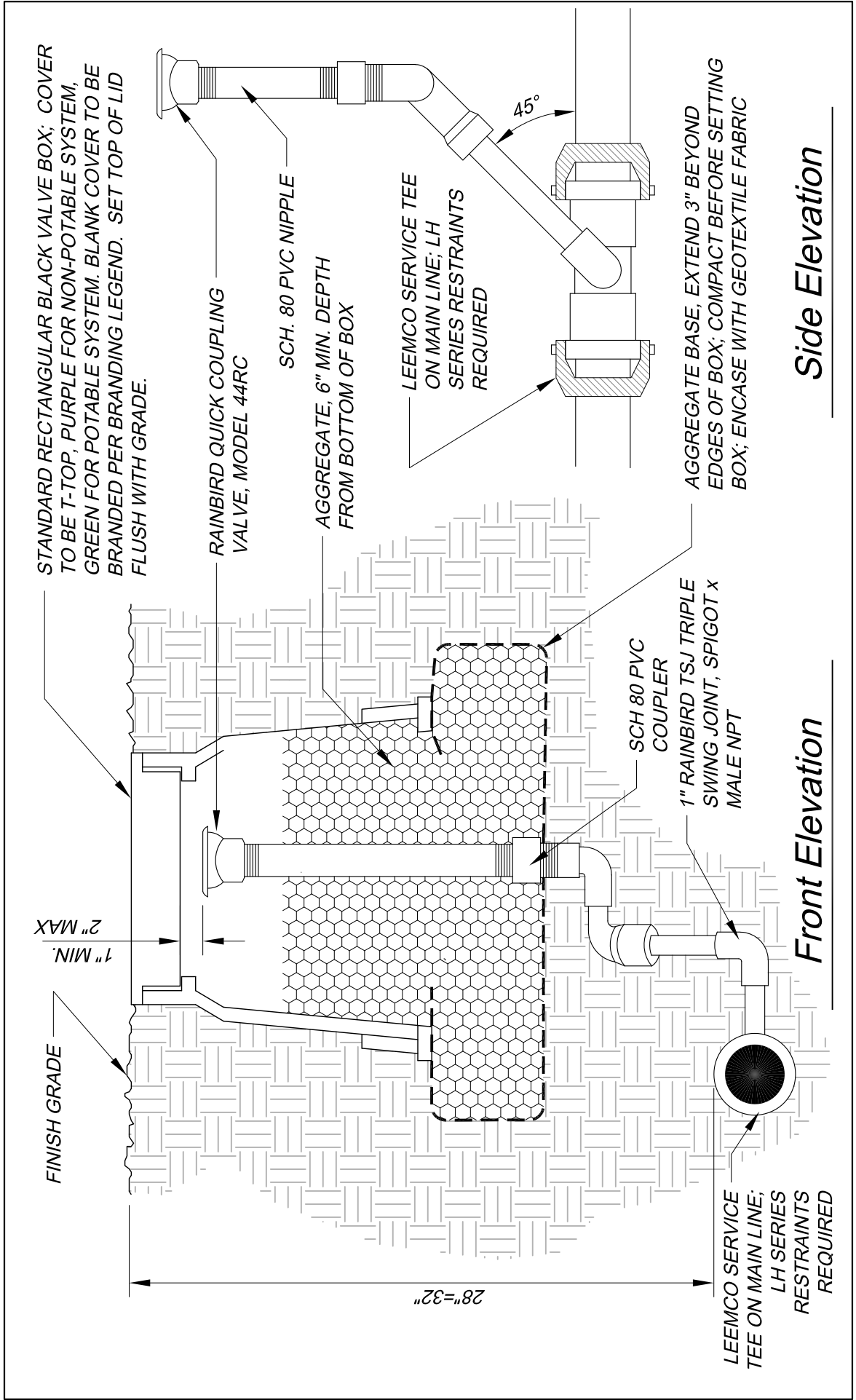

Front Elevation

Side Elevation

	<p>City of Aurora Parks, Recreation & Open Space Dept. Date: October 2020</p>	<p>QUICK COUPLING VALVE (not on lateral valve)</p>	<p>PROS I-4.3</p>
---	---	---	------------------------------

NOTES:

1. CONTRACTOR SHALL CONSTRUCT ONE VALVE ASSEMBLY FOR INSPECTION AND APPROVAL PRIOR TO PROCEEDING WITH OTHER VALVE INSTALLATIONS
2. EXTEND AGGREGATE UNDERNEATH AND BEYOND EDGES OF VALVE BOX

ALIGN LATERAL AT 90° TO MAIN LINE WHERE POSSIBLE; DO NOT LOCATE OVER AND PARALLEL TO MAIN LINE

ELECTRIC REMOTE CONTROL VALVE; SEE IRRIGATION LEGEND AND PLANS FOR SIZE AND TYPE

PVC SCH. 80 NIPPLE

PVC SCH. 80 UNION FPT x FPT

PVC SCH. 40 MALE ADAPTER

CUT NOTCH IN BOX FOR LATERAL LINE

CLASS 200 PVC LATERAL; SIZE TO MATCH VALVE

1'-6"

28"-32"

1.35"

2" MIN. CLEAR

JUMBO VALVE BOX

PLAN VIEW

DECODER; ALL WIRE CONNECTIONS TO BE DB CONNECTORS; SEE DETAIL BELOW
 QUICK COUPLING VALVE -- ATTACH TO LEEMCO ANGLE VALVE CONNECTION WITH BRASS STREET 90 AND 1" X CLOSE BRASS NIPPLE WHERE SHOWN ON PLANS
 JUMBO RECTANGULAR BLACK VALVE BOX; TOP TO BE T-TOP, GREEN FOR POTABLE SYSTEMS; PURPLE FOR NON-POTABLE SYSTEMS; BLANK COVER TO BE BRANDED PER BRANDING LEGEND; SET TOP OF COVER FLUSH WITH GRADE; USE 3" OR 6" EXTENSION IF NEEDED.

DECODER; ALL WIRE CONNECTIONS TO BE DB CONNECTORS
 QUICK COUPLING VALVE (SEE PLANS)
 LEEMCO LV-218 ANGLE VALVE CONNECTION WITH LMN ADAPTER (SPIGOT x NPT, SIZE TO MATCH VALVE SIZE) AT OUTLET; USE EXTENSION WHEN NEEDED

LEEMCO LATERAL TEE

IF END OF MAIN LINE, INSTALL LEEMCO PLUG

MAIN LINE; GASKET JOINT CLASS 200 PVC; SHOWN BENEATH LATERAL FOR ILLUSTRATIVE PURPOSES ONLY
 LEEMCO JOINT RESTRAINT; LH-SERIES

SECTION

GEOTEXTILE FABRIC - INSTALL AT BOTTOM OF BOX AND 4" UP EACH SIDE

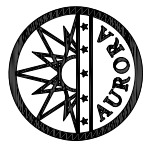

City of Aurora
 Parks, Recreation & Open Space Dept.
 Date: October 2020

ELECTRIC REMOTE CONTROL VALVE - 2 WIRE SYSTEM

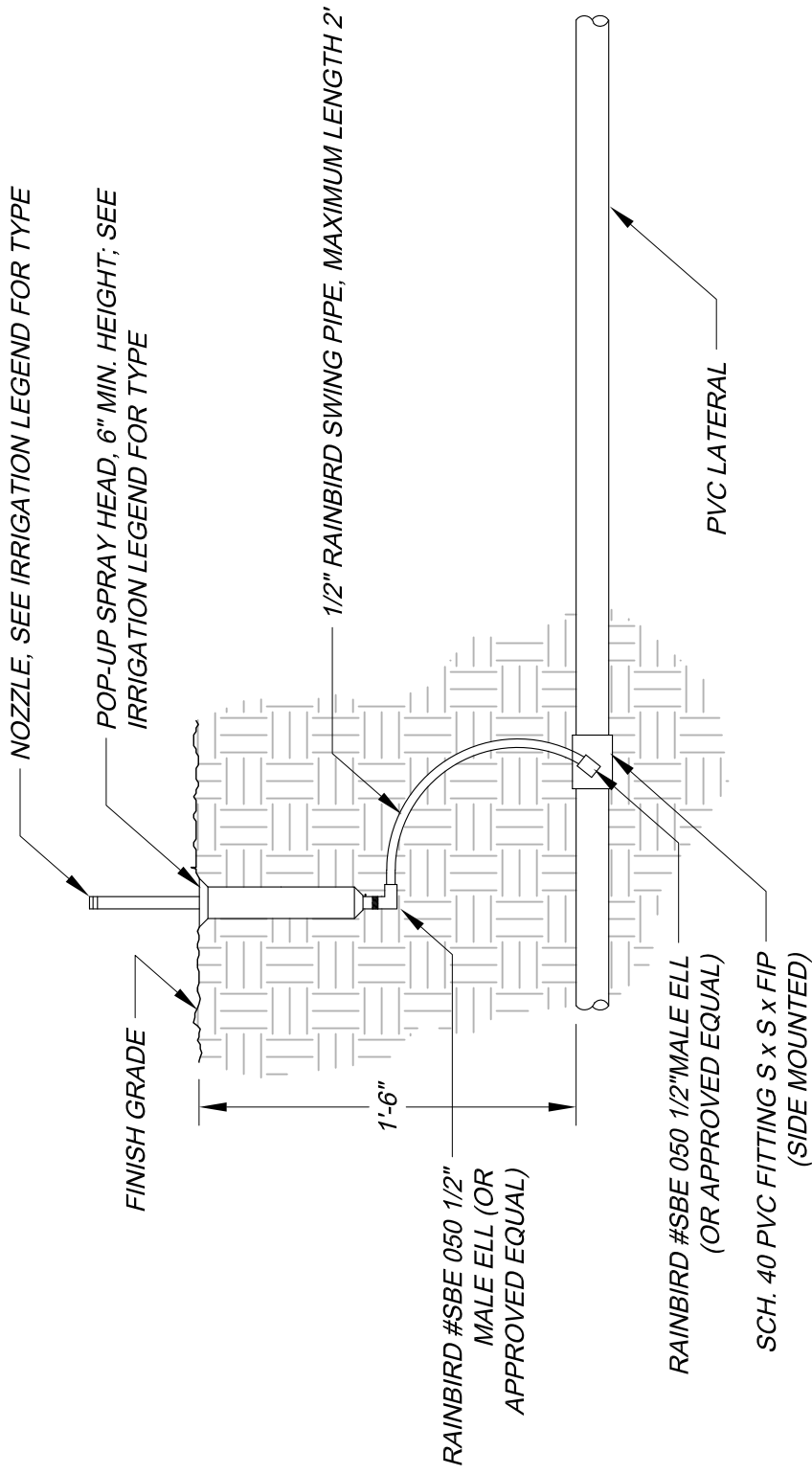

City of Aurora
 Parks, Recreation & Open Space Dept.
 Date: October 2020

POP-UP SPRAY HEAD

**PROS
 I-5.0**

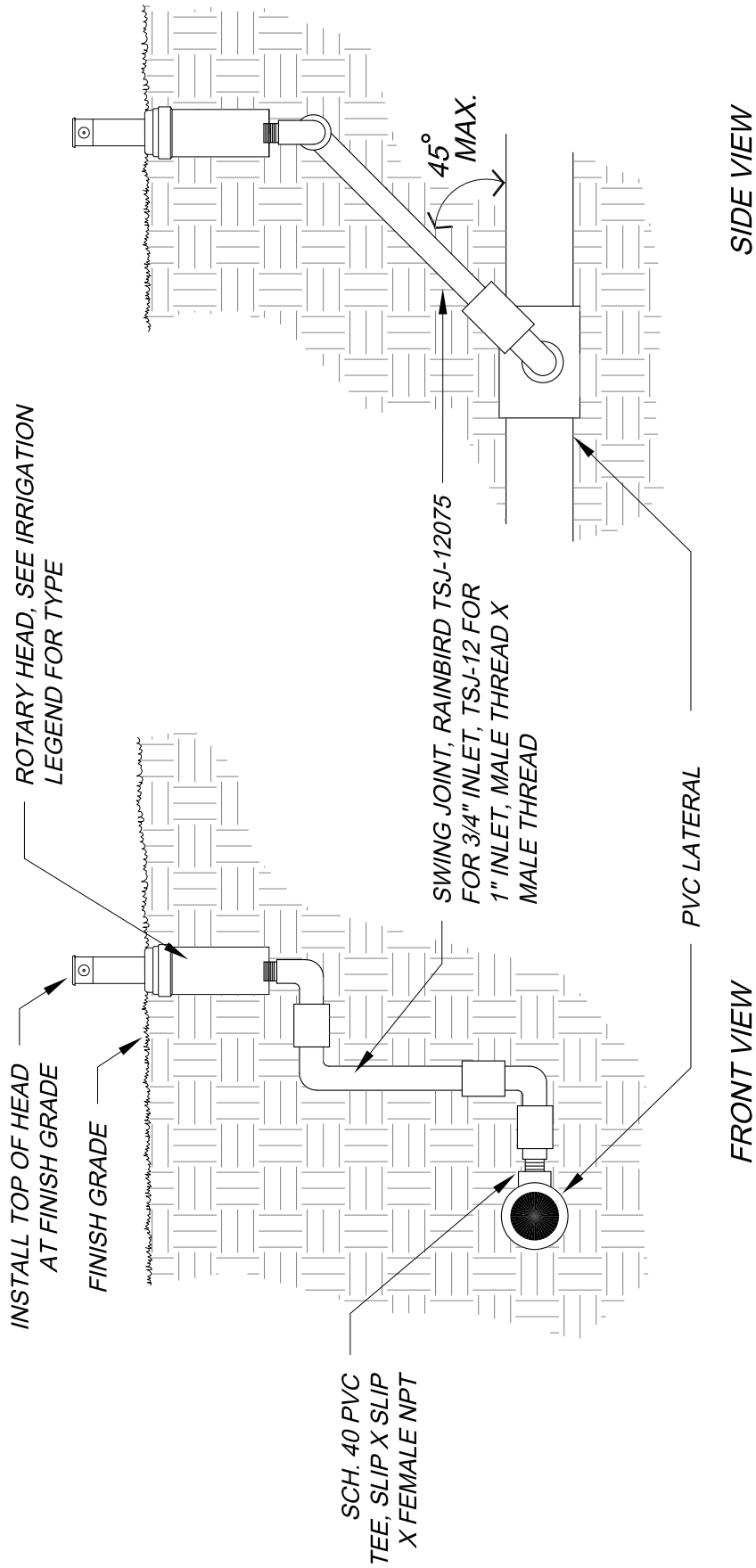

SIDE VIEW

FRONT VIEW

NOTE:

FOR ROTARY HEAD WITH 1/2" INLET, SEE POP-UP SPRAY HEAD DETAIL



City of Aurora
 Parks, Recreation & Open Space Dept.
 Date: October 2020

ROTARY HEAD

PROS I-5.1

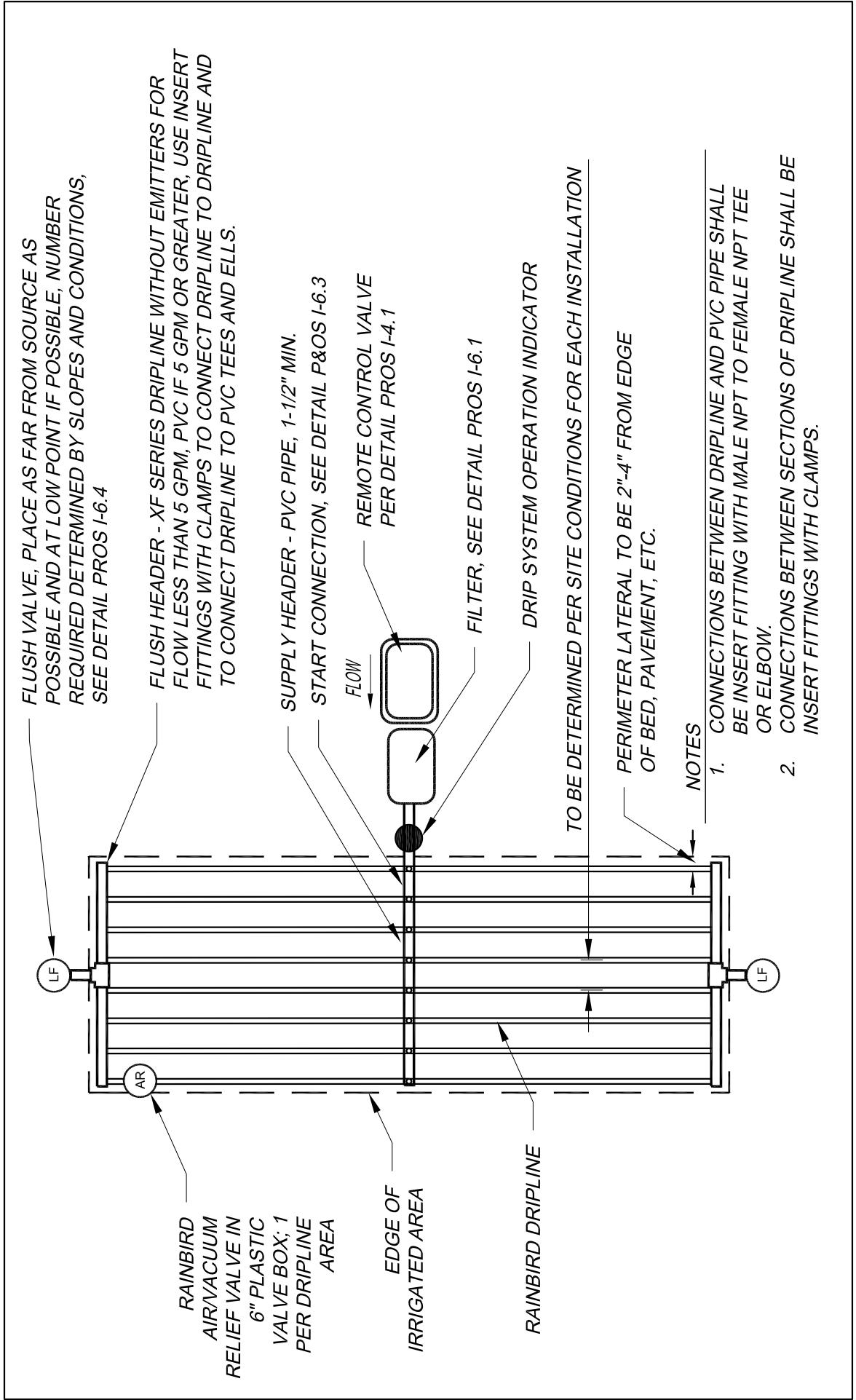



City of Aurora
Parks, Recreation & Open Space Dept.
Date: October 2020

**SUBSURFACE DRIP
LAYOUT**

**PROS
I-6.0**

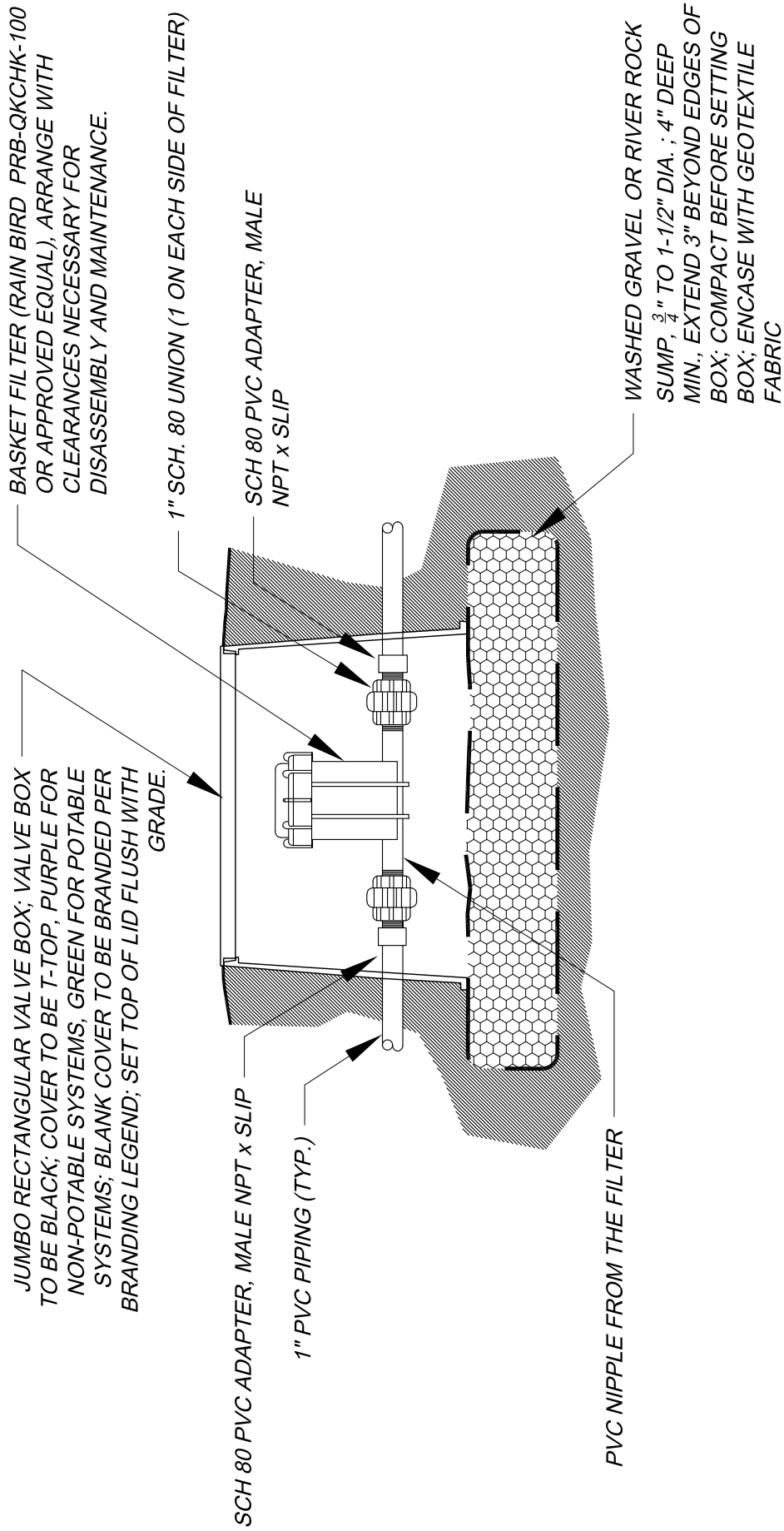



PROS
I-6.1

FILTER
(for drip irrigation)

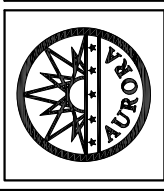
City of Aurora
Parks, Recreation & Open Space Dept.
Date: October 2020

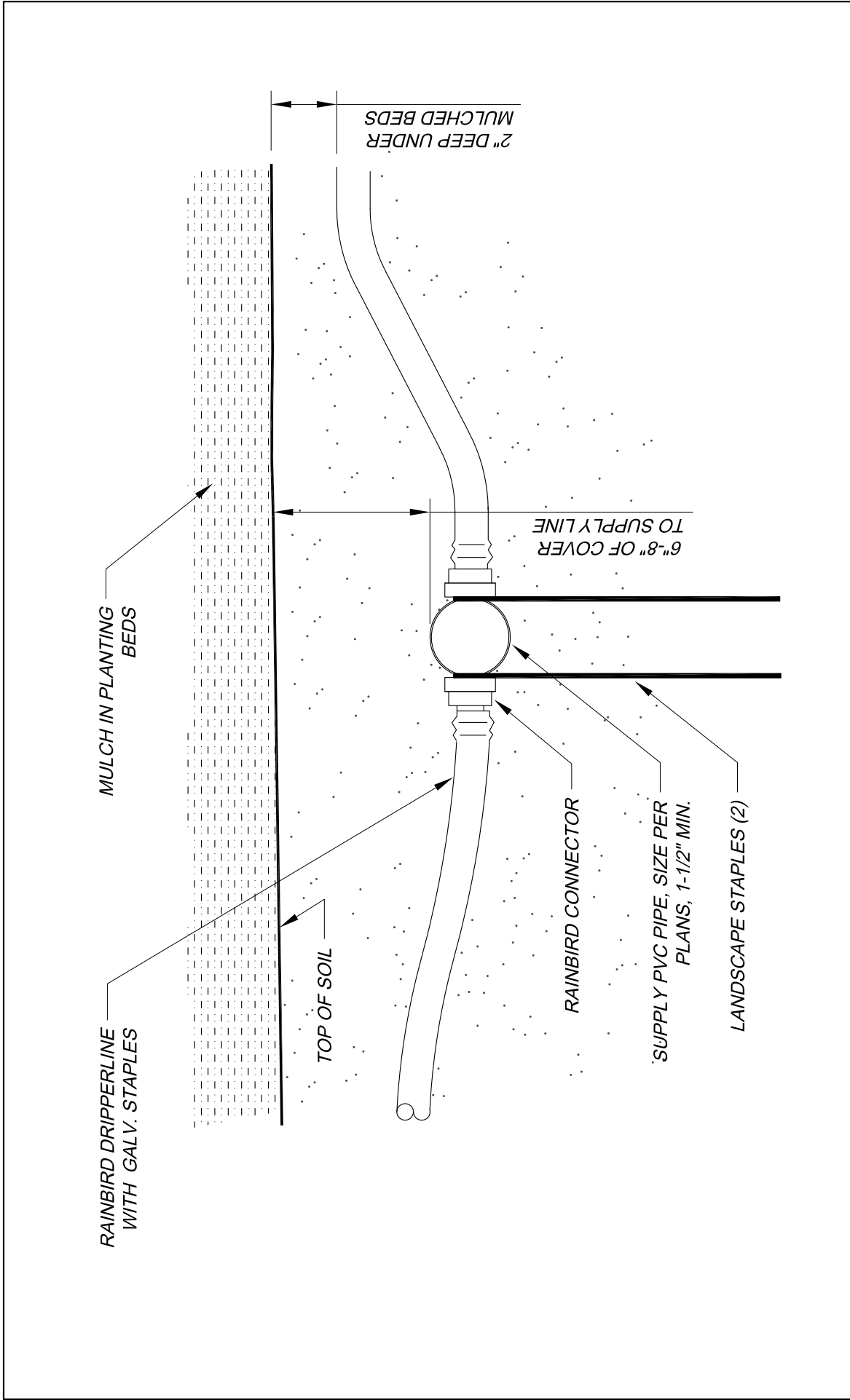



	<p>City of Aurora Parks, Recreation & Open Space Dept. Date: October 2020</p>	<p>DRIPPERLINE START CONNECTION</p>	<p>PROS I-6.3</p>
---	---	-------------------------------------	-------------------------------------

STANDARD RECTANGULAR, BLACK VALVE BOX, TOP TO BE T-TOP, GREEN FOR POTABLE SYSTEM, PURPLE FOR NON-POTABLE SYSTEM. BLANK COVER TO BE BRANDED PER BRANDING LEGEND. SET TOP OF COVER FLUSH WITH GRADE.

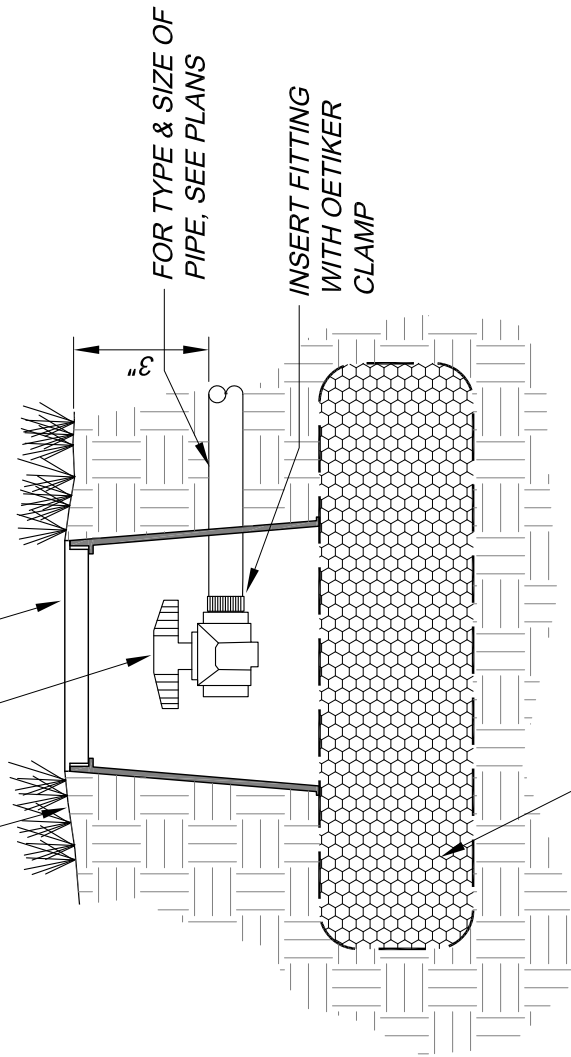

FOR TYPE & SIZE OF PIPE, SEE PLANS

INSERT FITTING WITH OETIKER CLAMP

WASHED GRAVEL OR RIVER ROCK BASE, $\frac{3}{4}$ " TO 1-1/2" DIA.; 4" DEEP MIN., EXTEND 3" BEYOND EDGES OF BOX. COMPACT BEFORE SETTING BOX; ENCASE IN GEOTEXTILE FABRIC.

City of Aurora
Parks, Recreation & Open Space Dept.
Date: October 2020



**SUBSURFACE
FLUSH VALVE**

**PROS
I-6.4**

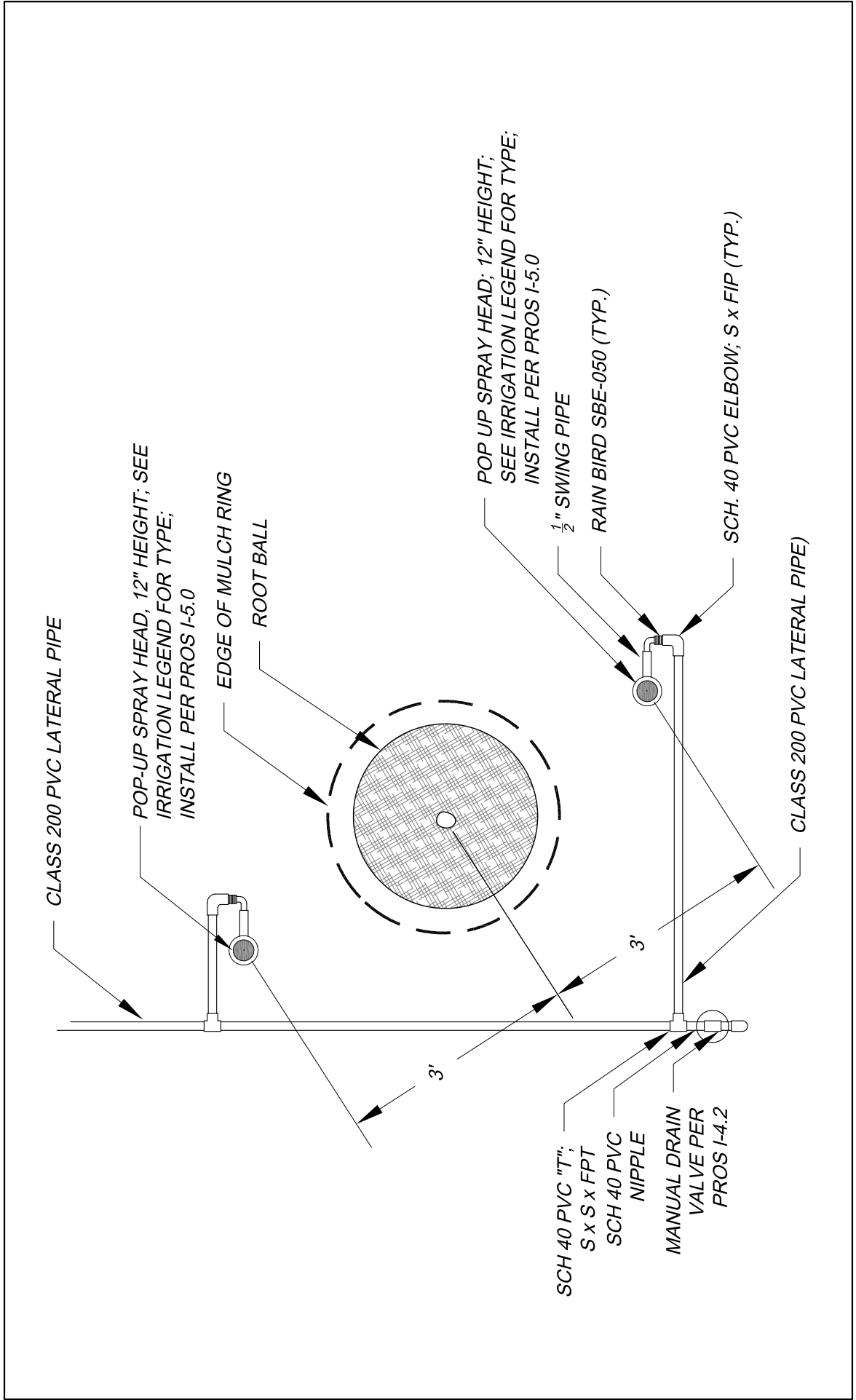

	<p>City of Aurora Parks, Recreation & Open Space Dept. Date: October 2020</p>	<p>SPRAY HEADS AT TREES</p>	<p>PROS I-6.6</p>
---	---	---------------------------------	------------------------------

PLANTING NOTES:

1. ALL EXISTING LANDSCAPE, IRRIGATION EQUIPMENT, CONCRETE OR FENCING, ON OR OFF SITE DISTURBED BY CONSTRUCTION OPERATIONS SHALL BE REPAIRED AND RESTORED BY THE CONTRACTOR TO CITY STANDARDS OR ORIGINAL CONDITION.
2. CONTRACTOR SHALL COORDINATE IRRIGATION AND PLANTING WORK SUCH THAT INSTALLED IRRIGATION EQUIPMENT SHALL NOT CAUSE ADJUSTMENT OF PLANTING LOCATIONS CONTRARY TO THE PLANS. IF IRRIGATION EQUIPMENT IS INSTALLED IN LOCATIONS OBSTRUCTING THE INTENDED LOCATIONS OF THE PLANTINGS, THE IRRIGATION EQUIPMENT SHALL BE RELOCATED.
3. ALL PLANT MATERIAL SHALL BE STAKED OR PLACED BY THE CONTRACTOR AND OBSERVED BY THE PROJECT MANAGER PRIOR TO PLANTING OPERATIONS. ALL PLANT MATERIAL SHALL BE OBSERVED AND APPROVED BY THE PROJECT MANAGER PRIOR TO INSTALLATION. FINAL LOCATION OF ALL PLANT MATERIAL SHALL BE SUBJECT TO THE APPROVAL OF THE PROJECT MANAGER.
4. CONTRACTOR SHALL HAND DIG ALL PLANTING PITS ADJACENT TO UTILITIES. IF UTILITIES ARE DAMAGED REPAIRS SHALL BE MADE AT THE CONTRACTOR'S COST.
5. PLANTING SHALL NOT BE DONE UNTIL IRRIGATION SYSTEM IS FULLY OPERATIONAL.
6. NEW TREES SHALL BE PLANTED A MINIMUM OF 20' AWAY FROM EACH OTHER AND 8' FROM WALKS, PATHS AND EDGES, UNLESS OTHERWISE DIRECTED BY PROJECT MANAGER. NO TREES SHALL BE PLANTED ABOVE IRRIGATION LINES OR UNDERGROUND UTILITIES.
7. ALL SHRUB/PERENNIAL PLANTING AREAS SHALL RECEIVE A 4" DEEP LAYER OF WOOD MULCH WITHOUT WEED BARRIER OR A 3" DEEP LAYER OF ROCK MULCH ON TOP OF WEED BARRIER. (SEE PLANS)
8. IF CONDITIONS DO NOT ALLOW STRICT CONFORMANCE TO THE NOTES, DETAILS AND SPECIFICATIONS, THE CONTRACTOR SHALL REQUEST APPROVAL FROM THE CITY OF AURORA PROJECT MANAGER OR PROJECT SUPERVISOR BEFORE PERFORMING WORK IN AN ALTERNATIVE MANNER.



*City of Aurora
Parks, Recreation & Open Space Dept.
Date: October 2020*

**PLANTING
NOTES**

**PROS
L-1.0**

DO NOT CUT OR DAMAGE LEADER. REMOVE BROKEN, DAMAGED AND DEAD BRANCHES. PERFORM NO OTHER PRUNING AT TIME OF PLANTING

12 GAUGE WIRE AND NYLON TREE STRAP AROUND TRUNK, ALLOW FOR LIMITED MOVEMENT OF TRUNK. PLACE SURVEYOR'S TAPE ON EACH GUY WIRE

WRAP TREE PER SPECIFICATION

INSTALL 2 STEEL 'T' STAKES 180 DEGREES APART, EITHER PARALLEL WITH STREET OR SIDEWALK OR WITH ONE STAKE ON UP-WIND SIDE. PLACE STAKES IN UNDISTURBED SOIL AND INSIDE MULCH RING. INSTALL PLASTIC HIGH-VISIBILITY CAP ON EACH STAKE.

REMOVE SOIL FROM TOP OF ROOT BALL TO ELEVATION OF TOP OF ROOT FLARE. PLANT TREE SO THAT TOP OF ROOT FLARE IS LEVEL WITH ADJACENT GRADE. DO NOT PLACE SOIL ABOVE TOP OF ROOT FLARE.

36"-48" WIDE RING OF SPECIFIED ORGANIC MULCH, 4" DEPTH. OUTER EDGE OF MULCH TO BE 2" BEYOND TREE STAKES; MULCH TO BE 3" FROM TRUNK.

FINISH GRADE 4:1 MAX. SLOPE ALL SIDES

REMOVE ALL CONTAINMENT MATERIALS FROM TOP 2/3 OF ROOT BALL. REMOVE ENTIRE WIRE BASKET OR PLASTIC POT FROM THE ROOT BALL. DAMAGED ROOT BALLS WILL BE REJECTED.

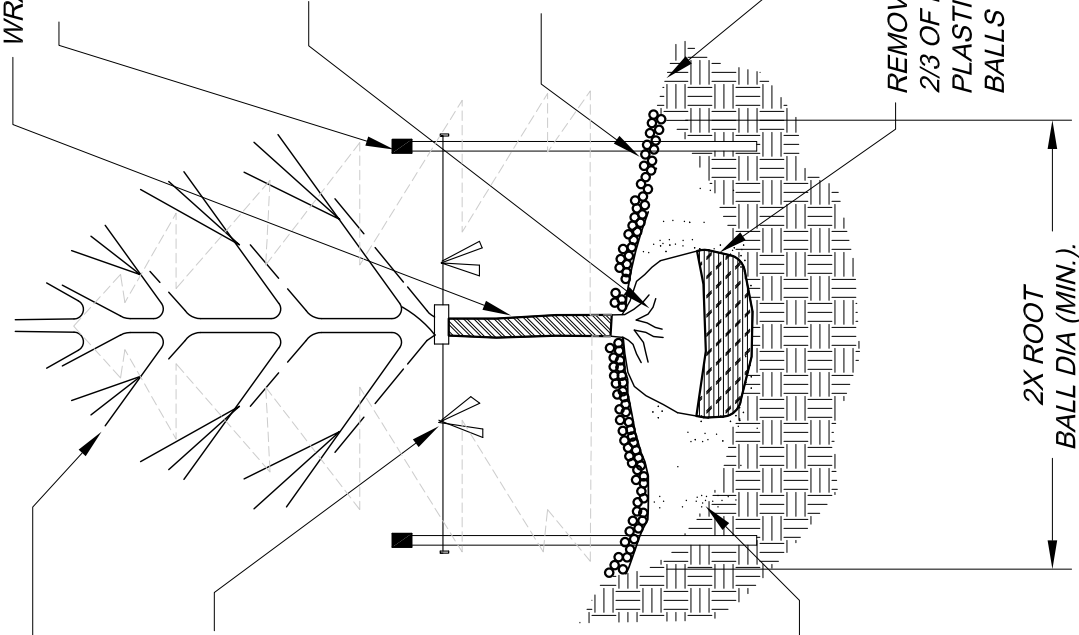

DIG TREE PIT AS SHOWN; SCARIFY SURFACE OF PIT; BOTTOM OF PIT TO BE NO DEEPER THAN NECESSARY; PLACE TREE ON A MAXIMUM OF TWO INCHES OF COMPACTED TOPSOIL SPREAD ON UNDISTURBED SUB-GRADE; PLANT PIT BACKFILL MIX SHALL BE PER SPECIFICATION



City of Aurora
Parks, Recreation & Open Space Dept.
Date: October 2020

DECIDUOUS &
EVERGREEN TREE

PROS
L-2.0

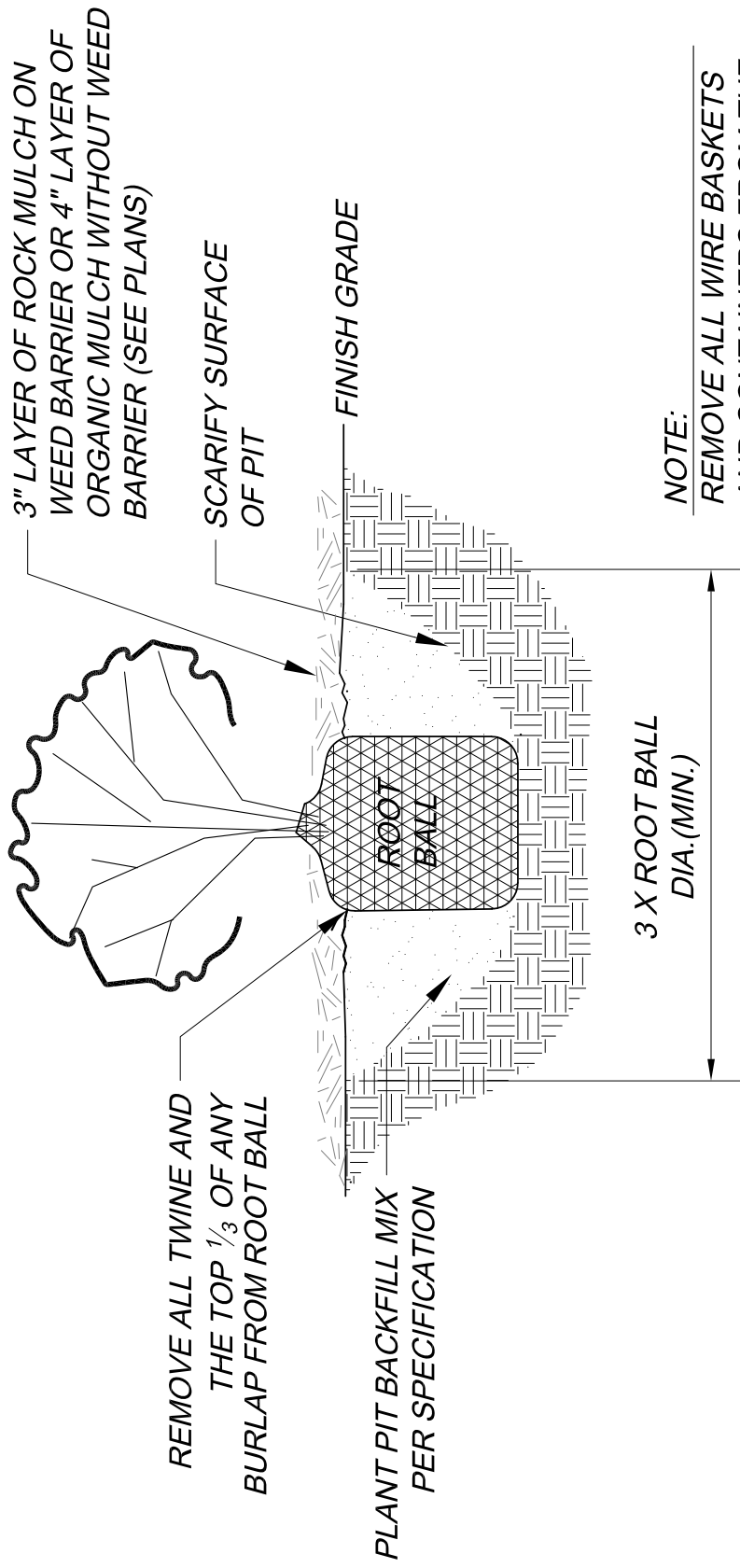

NOTE:
 REMOVE ALL WIRE BASKETS
 AND CONTAINERS FROM THE
 ROOT BALL.

City of Aurora
 Parks, Recreation & Open Space Dept.
 Date: October 2020

SHRUB

**PROS
 L-2.1**



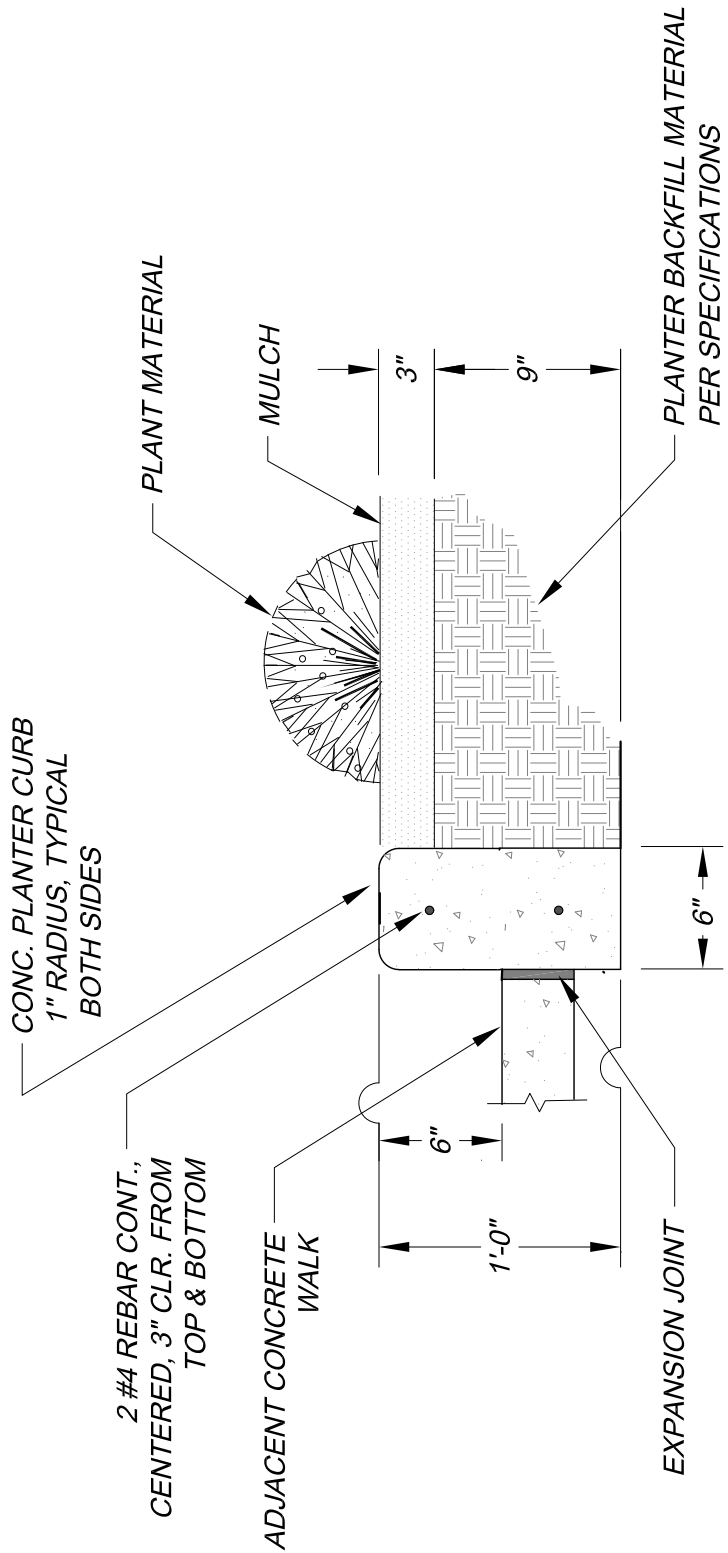

NOTE:

1/4" WIDE, FULL DEPTH EXPANSION JOINTS SHALL BE PLACED
IN MOW STRIP AT 30' O.C. JOINT SEALANT SHALL BE APPLIED WITHIN
EXPANSION JOINTS. CONTROL JOINTS TO BE PLACED EVERY 10' O.C.

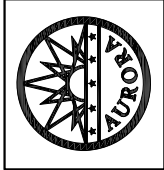

City of Aurora
Parks, Recreation & Open Space Dept.
Date: October 2020

**CONCRETE
PLANTER CURB**

**PROS
L-3.0**

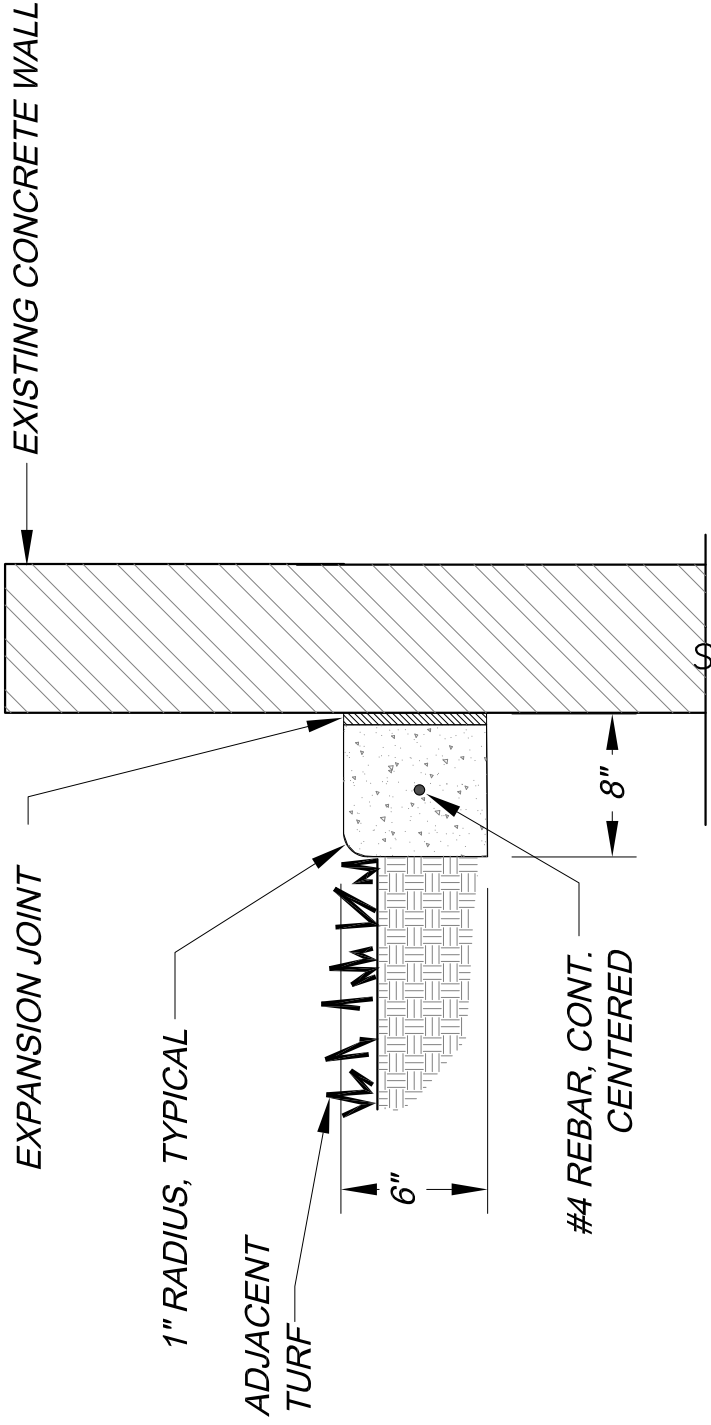

NOTE:

1/4" WIDE, FULL DEPTH EXPANSION JOINTS SHALL BE PLACED IN MOW STRIP AT 30' O.C. JOINT SEALANT SHALL BE APPLIED WITHIN EXPANSION JOINTS. CONTROL JOINTS TO BE PLACED EVERY 10' O.C.



City of Aurora
Parks, Recreation & Open Space Dept.
Date: October 2020

MOW STRIP

PROS
L-3.1

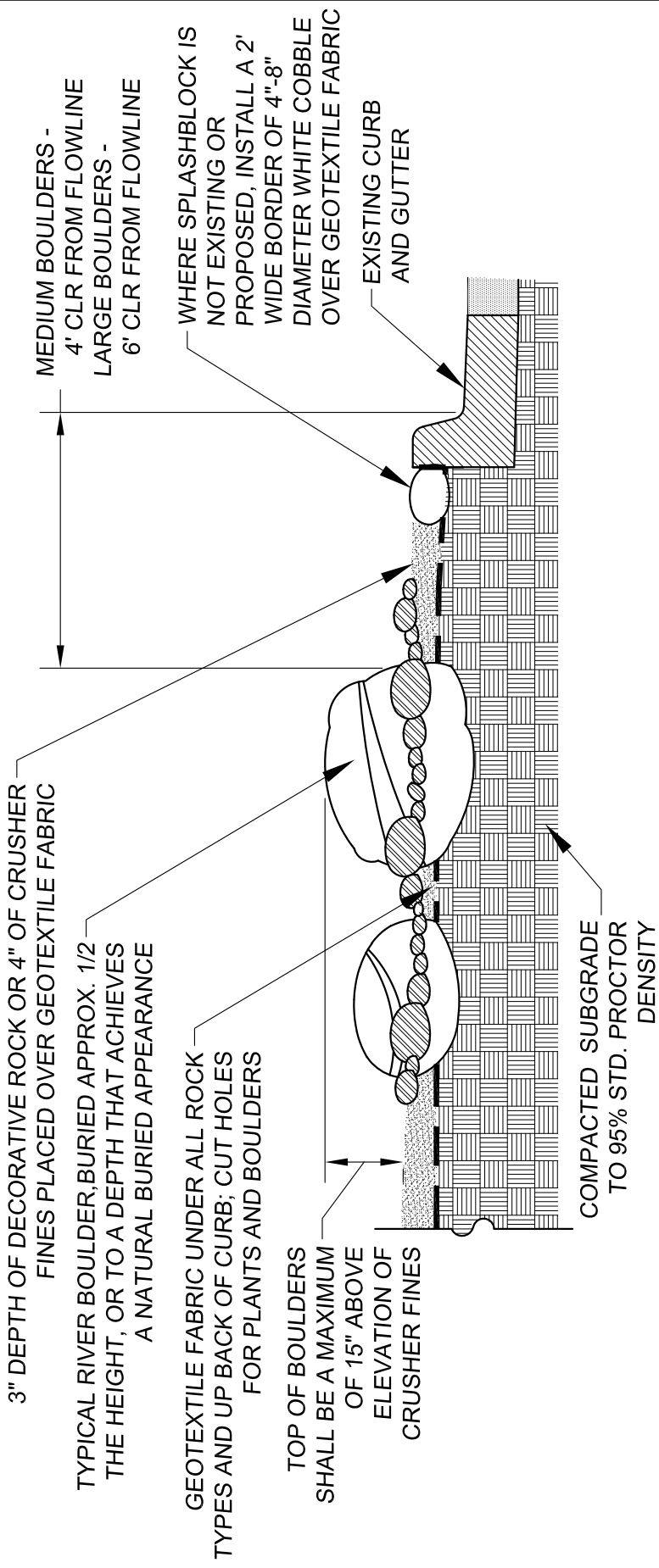

NOTES:

1. MEDIUM BOULDERS SHALL BE 2'-3' IN TWO DIMENSIONS; LARGE BOULDERS SHALL BE 3'-4' IN TWO DIMENSIONS.
2. BOULDERS SHALL BE EARTH-TONE COLORS (NO WHITE, RED OR PINK BOULDERS); COLORS THAT CONTRAST WITH THE COLOR OF ADJACENT ROCK TYPES ARE PREFERRED.
3. GEOTEXTILE FABRIC WITHIN MEDIANS SHALL BE MIRAFI 140N OR APPROVED EQUAL.



City of Aurora
 Parks, Recreation & Open Space Dept.
 Date: October 2020

**BOULDERS IN
 A MEDIAN**

**PROS
 M-1.2**

NOTES

1. INSTALL UNDERDRAIN IN THE LOCATIONS SHOWN ON THE PLANS.
2. MIN. SLOPE OF UNDERDRAIN PIPE SHALL BE 1%.
3. SEE SPECIFICATIONS FOR FURTHER INFORMATION REGARDING RESILIENT MATTING SURFACING.

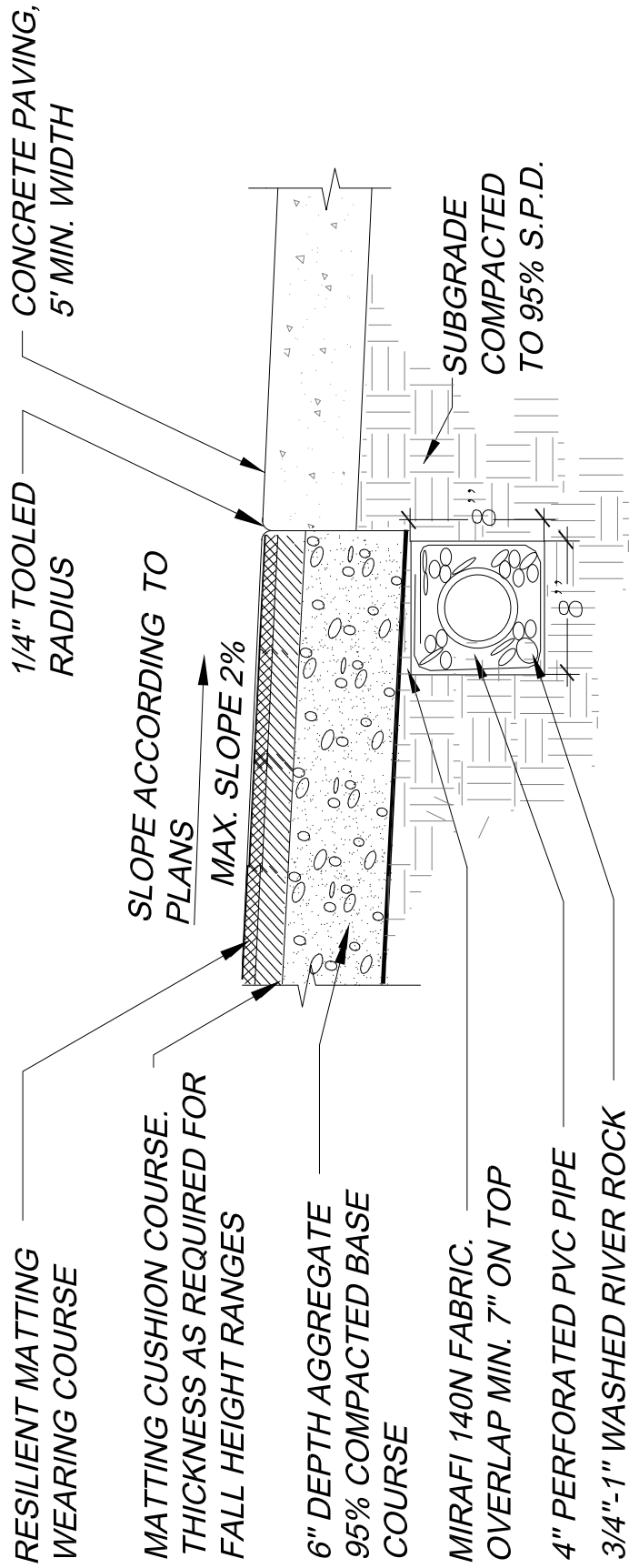

City of Aurora
Parks, Recreation & Open Space Dept.
Date: October 2020

PLAYGROUND SURFACING
AGAINST SIDEWALK

PROS
P-1.0

NOTES:

1. VENT PIPE MUST BE FACING TO THE SOUTH. DOOR ORIENTATION IS TOWARDS NORTH.
2. SEE SPECIFICATION SECTION 02800 FOR RESTROOM MANUFACTURER.
3. INSTALL PREFABRICATED VAULT RESTROOM AS PER MANUFACTURER'S INSTALLATION SPECIFICATIONS.

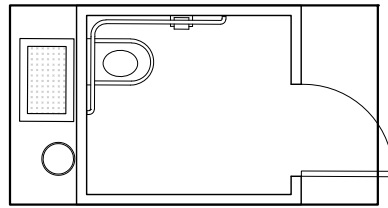
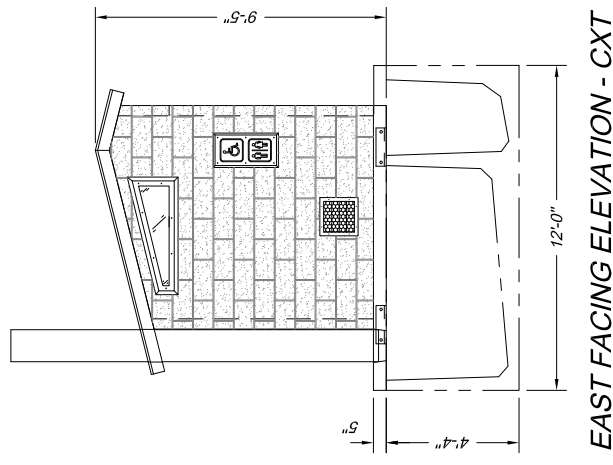
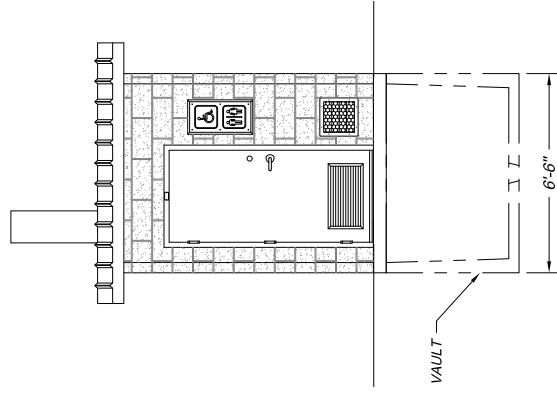
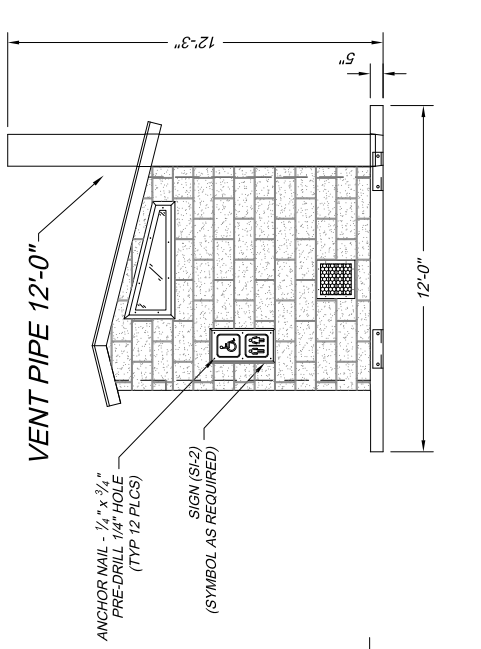
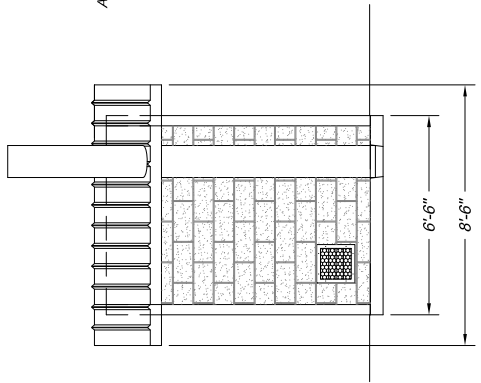

City of Aurora
 Parks, Recreation & Open Space Dept.
 Date: October 2020

**RESTROOM WITH
 VAULT TOILET**

**PROS
 R-1.0**

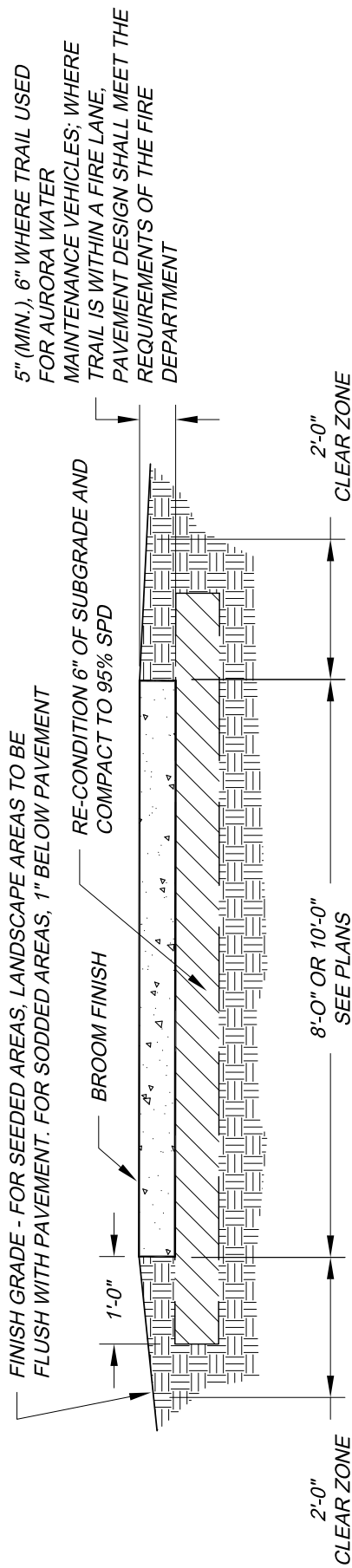

NOTES:

1. CONCRETE MIX TO BE CITY APPROVED 4500lb MIX WITH FIBERMESH REINFORCING. SEE PROS STANDARD SPECIFICATION FOR ADDITIONAL INFORMATION.
2. TRANSVERSE JOINTS TO BE SAWCUT (1/8" WIDE x 1-1/4" DEEP). SPACING TO MATCH WIDTH OF TRAIL OR AS DIRECTED. SAWCUT JOINT REQUIRED ON THE CENTERLINE IF TRAIL IS MORE THAN 10' WIDE.
3. EXPANSION JOINTS, WITH FILLER AND SEALANT, TO BE PLACED EVERY 200', WHERE PAVEMENT ABUTS EXISTING PAVEMENTS OR STRUCTURES, OR AS DIRECTED.
4. PROVIDE ADDITIONAL ROAD BASE AS NEEDED FOR CONSTRUCTION OR COMPACTION OF TRAIL SUBGRADE
5. COMPACT SUBGRADE UNDER AND 1' BEYOND EACH SIDE OF TRAIL, PRIOR TO PLACING FORMS
6. BACKFILL EDGES OF TRAIL WITH ON-SITE MATERIAL, PREPARE LANDSCAPE AREA PER SPECIFICATIONS, AND SEED OR SOD PER PLANS.
7. SLOPE ON TRAIL SHALL BE A MINIMUM OF 1.5% IN ONE DIRECTION AND SHALL PROVIDE POSITIVE DRAINAGE OFF OF THE TRAIL; MAXIMUM CROSS SLOPE SHALL BE 2%. LONGITUDINAL SLOPE SHALL BE LESS THAN 5%.
8. 2' WIDE CLEAR ZONE ON EACH SIDE OF TRAIL SHALL BE FREE OF OBSTRUCTIONS. SLOPE SHALL BE A MAXIMUM OF 2%. IF BEYOND THE 2' CLEAR ZONE THERE IS A BODY OF WATER OR A SLOPE OF 3:1 OR GREATER WITH A TOTAL HEIGHT OF 6' OR MORE, A 5' WIDE CLEAR ZONE OR A 54" HIGH RAILING IS REQUIRED.
9. WHERE REPLACING TRAIL OR INSTALLING NEW CONCRETE ABUTTING EXISTING TRAIL, INSTALL SMOOTH #4 DOWELS, 24" LONG, AT 24" O.C.; IF EXPANSION JOINT IS REQUIRED, GREASE AND WRAP ONE END OF EACH DOWEL; CITY INSPECTOR WILL DETERMINE IF EXPANSION JOINTS ARE REQUIRED ADJACENT TO EXISTING CONCRETE; DEPENDING ON SUBGRADE DISTURBANCE AND SITE CONDITIONS, CITY INSPECTORS MAY REQUIRE RE-COMPACTION OF SUBGRADE AND COMPACTION TESTING; IF MORE THAN ONE 10' LONG SECTION IS BEING REPLACED PER 30 LINEAR FEET OF TRAIL (2 PER 60LF, 3 PER 90LF, ETC.) WITH LESS THAN 30' BETWEEN SECTIONS BEING REPLACED, ALL CONCRETE BETWEEN THE SECTIONS BEING REPLACE MUST ALSO BE REPLACED.

5" (MIN.), 6" WHERE TRAIL USED FOR AURORA WATER MAINTENANCE VEHICLES; WHERE TRAIL IS WITHIN A FIRE LANE, PAVEMENT DESIGN SHALL MEET THE REQUIREMENTS OF THE FIRE DEPARTMENT



City of Aurora
 Parks, Recreation & Open Space Dept.
 Date: October 2020

MULTI-USE TRAIL

PROS T-1.0

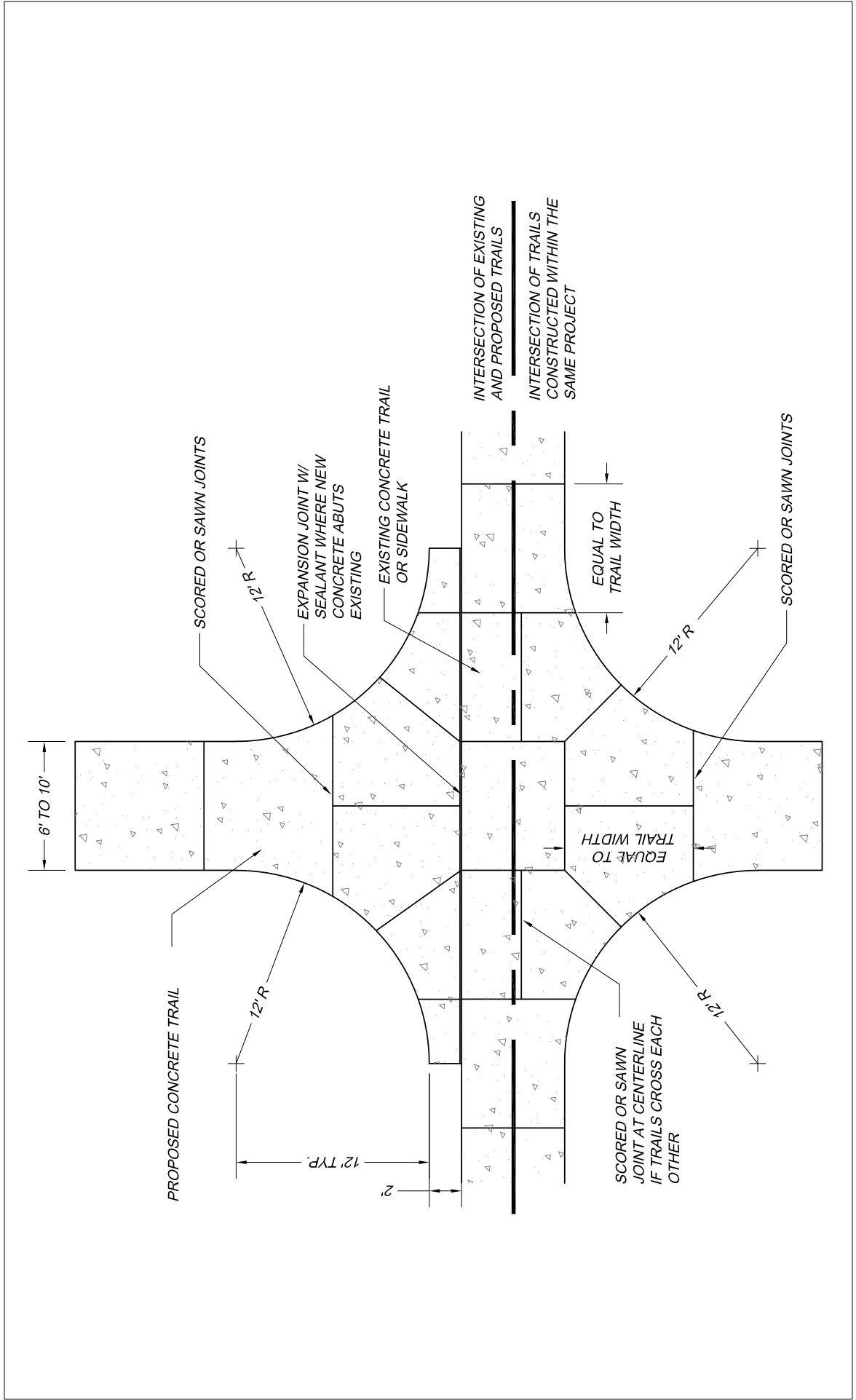



PROS
T-1.1

TRAIL
INTERSECTIONS

City of Aurora
Parks, Recreation & Open Space Dept.
Date: October 2020

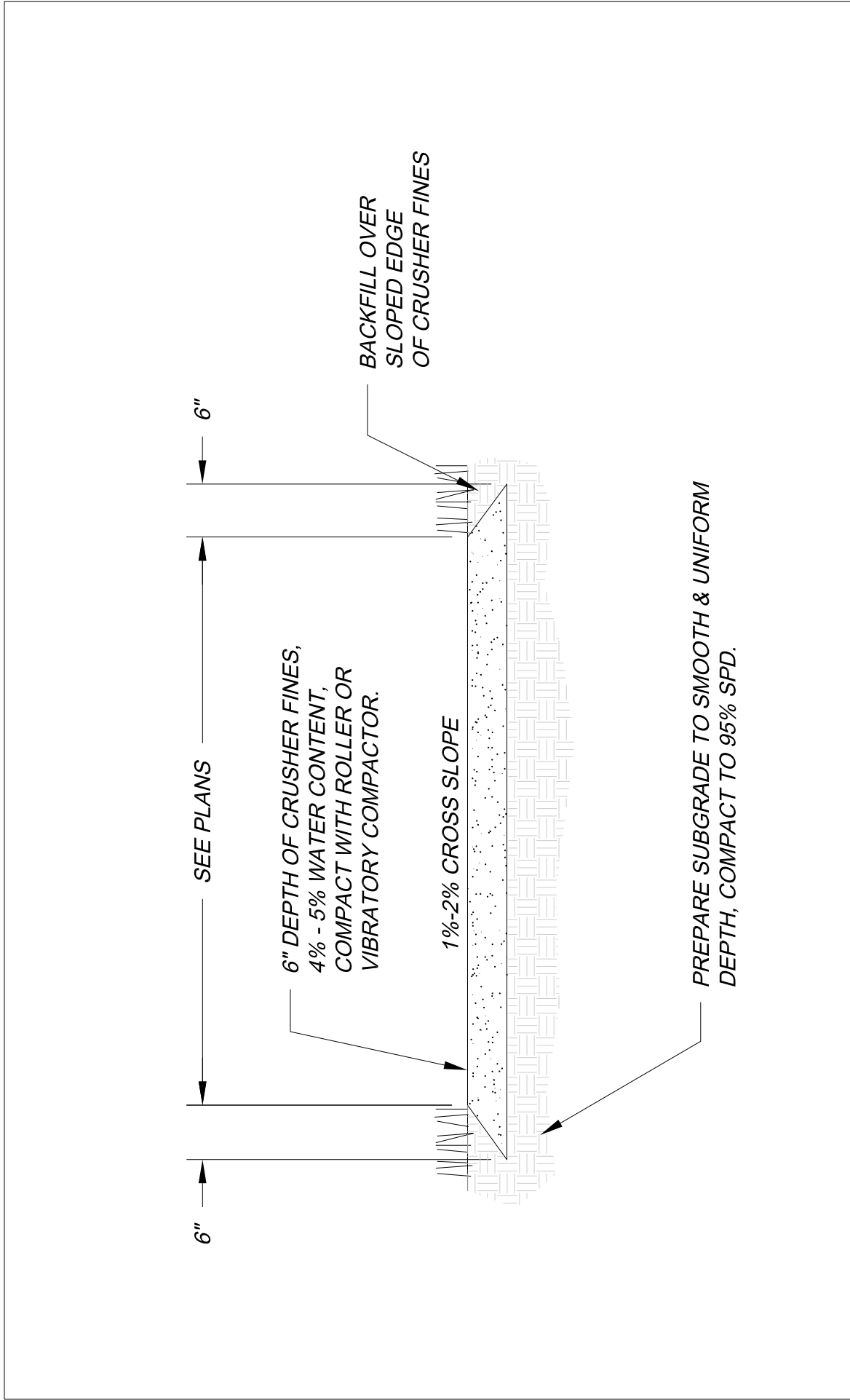



	<p>City of Aurora Parks, Recreation & Open Space Dept. Date: October 2020</p>	<p>CRUSHER FINES TRAIL</p>	<p>PROS T-2.0</p>
---	---	--------------------------------	-------------------------------------

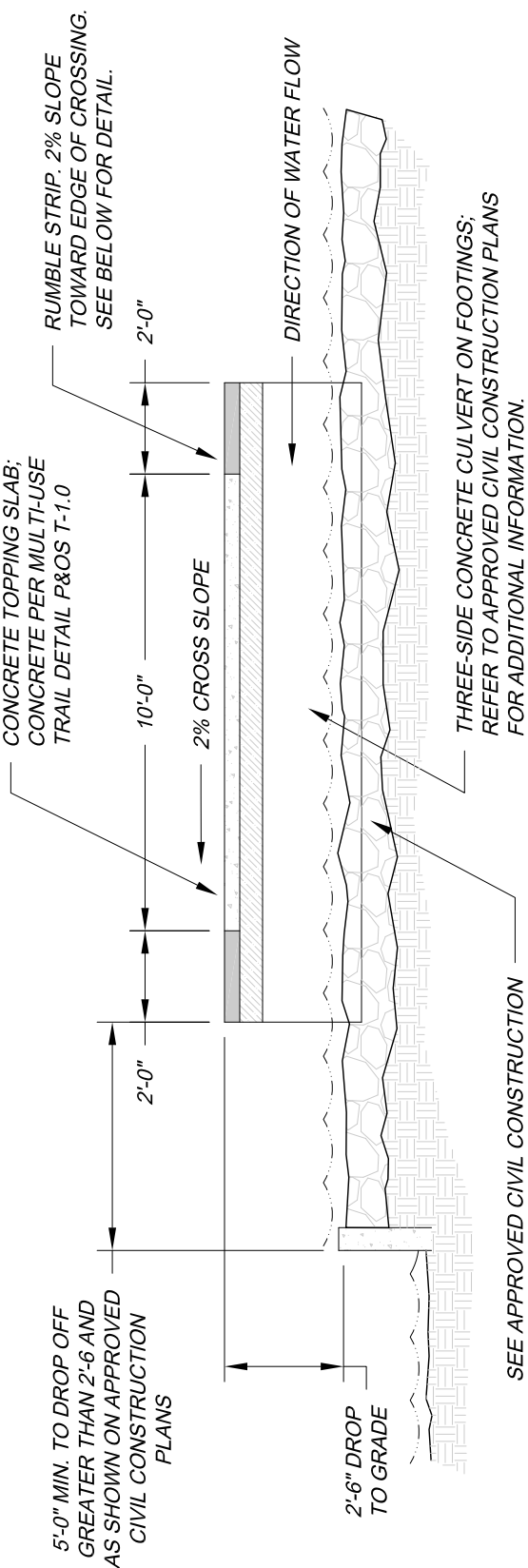

CROSS SECTION

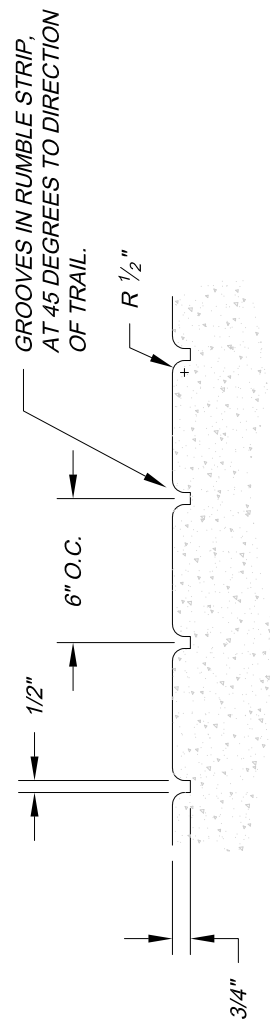

RUMBLE STRIP DETAIL

City of Aurora
 Parks, Recreation & Open Space Dept.
 Date: October 2020



LOW WATER
 TRAIL CROSSING

**PROS
 T-3.0**

TREE PROTECTION NOTES

1. PRIOR TO THE BEGINNING OF CONSTRUCTION, ESTABLISH THE TREE PROTECTION ZONE BY INSTALLING TREE PROTECTION FENCING AROUND ALL EXISTING TREES TO REMAIN. LOCATE FENCING AT THE OUTSIDE OF THE DRIP LINE OF THE TREES OR AT A DISTANCE FROM THE TREE TRUNK OF ONE(1) FOOT OF RADIUS FOR EVERY INCH OF TRUNK DIAMETER, WHICHEVER IS GREATER. FOR GROUPS OF TREES, THE MINIMUM DISTANCE BETWEEN THE TREE TRUNK AND THE FENCING SHALL BE ONE(1) FOOT FOR EACH INCH OF TRUNK DIAMETER. FOLLOWING INSTALLATION OF FENCING, REQUEST INSPECTION BY THE CITY OF AURORA PARKS & FORESTRY DIVISION (303-739-7177) OR AUTHORIZED DESIGNEE.
2. TREE PROTECTION FENCING SHALL BE 4' HEIGHT, ORANGE MESH FENCING ATTACHED TO 'T' POSTS. FENCING SHALL BE INSPECTED AND MAINTAINED DAILY.
3. CONTRACTORS SHALL BE RESPONSIBLE FOR ALL OF THEIR WORKERS, SUBCONTRACTORS AND SUPPLIERS UNDER THIS REQUIREMENT. WITHIN THE TREE PROTECTION ZONE, THE FOLLOWING CONSTRUCTION ACTIVITIES SHALL NOT BE ALLOWED EXCEPT AS NECESSARY TO EXECUTE DETAILS TP-2.0, 2.1, 3.1 & 3.2:
 - A. EQUIPMENT USE AND STORAGE
 - B. MATERIAL DELIVERY OR STORAGE
 - C. VEHICLE TRAFFIC, PARKING, USE OR STORAGE
 - D. SPREADING, EXCAVATING, COMPACTING OR STOCKPILING OF SOIL
 - E. CONCRETE WASH-OUT AREAS AND RUN-OFF FROM CONCRETE WASH-OUT AREAS
 - F. FOOT TRAFFIC
 - G. RUN-OFF CONTAINING HARMFUL LIQUIDS SUCH AS OIL, GAS, PAINT, SOLVENTS, FERTILIZER, ASPHALT, MORTAR, TAR OR SIMILAR MATERIALS
4. VIOLATION OF THE TREE PROTECTION ZONE SHALL RESULT IN A FINE OF \$500 PER INCIDENCE AND MAY BE INCREASED BASED ON THE PERCENTAGE OF THE ZONE AFFECTED MULTIPLIED BY THE FULL VALUE OF THE TREE (OR TREES) ESTABLISHED PRIOR TO CONSTRUCTION. IF MORE THAN 30% OF THE TREE PROTECTION ZONE IS DAMAGED, THE FINE SHALL BE THE FULL VALUE OF THE ADJACENT TREE (OR TREES). FOR THE PURPOSE OF THESE REQUIREMENTS, CONSTRUCTION FENCING (LOCATED AT THE LIMITS OF CONSTRUCTION) SHALL BE TREATED AS TREE PROTECTION FENCING AND SHALL ESTABLISH A TREE PROTECTION ZONE FOR NEARBY TREES.
5. DAMAGE TO THE MAIN TRUNKS OF TREES IS PROHIBITED. DAMAGE NOT PREVIOUSLY DOCUMENTED SHALL RESULT IN A FINE BASED ON THE PERCENTAGE OF THE CIRCUMFERENCE AFFECTED. DAMAGE GREATER THAN 30% OF THE CIRCUMFERENCE OR AFFECTING THE STRUCTURAL INTEGRITY OF THE TREE WILL RESULT IN A FINE EQUAL TO THE FULL VALUE OF THE TREE.
6. LIMB REMOVAL IS PROHIBITED, UNLESS APPROVED PRIOR TO CONSTRUCTION OR AS AUTHORIZED BY THE CITY OF AURORA PARKS & FORESTRY DIVISION. LIMB REMOVAL, IF APPROVED, SHALL BE DONE PRIOR TO THE START OF CONSTRUCTION. DAMAGED BRANCHES SHALL BE PRUNED WITHIN 10 DAYS OF THE OCCURRENCE UTILIZING ANSI A300 STANDARDS. UNAUTHORIZED LIMB DAMAGE OR REMOVAL CAN RESULT IN A FINE OF \$500 PER BRANCH AS MAY BE DETERMINED BY THE CONSTRUCTION MANAGER OR HIS FORESTRY CONSULTANT. LIMB REMOVAL AND ALL OTHER APPROVED PRUNING SHALL BE PERFORMED BY A PROFESSIONAL COMPANY THAT IS LICENSED BY THE CITY OF AURORA FORESTRY DIVISION.
7. IF ROOTS GREATER THAN ONE(1) INCH DIAMETER REQUIRE CUTTING/REMOVAL, A CLEAN CUT SHALL BE ACCOMPLISHED USING A SHARP HAND TOOL. A MAXIMUM OF TWO(2) 3-INCH DIAMETER ROOTS PER TREE ARE PERMITTED FOR REMOVAL. THE REMOVAL OF ADDITIONAL ROOTS 3-INCHES OR GREATER IN DIAMETER REQUIRES APPROVAL OF THE CITY FORESTER OR AUTHORIZED DESIGNEE.
8. EXISTING TREES DAMAGED BY CONSTRUCTION ACTIVITIES SHALL BE IMMEDIATELY REPAIRED AND IF DAMAGED BEYOND REPAIR, REPLACED PER THE MITIGATION SPECIFICATIONS OUTLINED IN SECTION IV, SUBSECTION A, ITEM 3 OF THE TREE PRESERVATION POLICY. THE MITIGATION PLAN FOR THESE TREES SHALL FOLLOW THAT APPROVED THROUGH THE SITE PLAN SUBMITTAL.



City of Aurora
Parks, Recreation & Open Space Dept.
Date: October 2020

TREE PROTECTION NOTES

PROS
TP-1.0

FORMULA FOR LIMIT OF DISTURBANCE:

ROOT ZONE DISTURBANCE SHALL NOT BE ALLOWED CLOSE TO THE TRUNK OF ANY TREE TO BE PRESERVED. MINIMUM DISTANCE BETWEEN THE TRUNK AND THE DISTURBANCE SHALL BE EQUAL TO 1/2 OF THE TREE'S DIAMETER CONVERTED TO FEET. (FOR EXAMPLE, FOR A TREE WITH A 15" DIAMETER TRUNK, THE DISTURBANCE CAN NOT BE CLOSER THAN 7.5 FEET FROM THE TRUNK.

REQUIRED TREATMENTS:

1. APPLY PREVENTATIVE SPRAY FOR MOUNTAIN PINE BEETLE (MPB) AND IPS TO PONDEROSA, AUSTRIAN & SCOTCH PINES. TREAT ALL BARK SURFACES, INCLUDING TOP BRANCHES.
2. IF DISTURBANCE LEAVES A CUT SLOPE, IMMEDIATELY APPLY MULCH AND WATER. IF DISTURBANCE IS A TRENCH, IMMEDIATELY BACKFILL AND WATER.
3. ONCE PER MONTH, EVALUATE TREE TO DETERMINE IF TREE IS LEANING OR IF BRANCHES / LEAVES ARE AFFECTED BY ROOT LOSS.
4. DO NOT FERTILIZE.
5. INSPECT TREE 2-3 TIMES PER YEAR FOR WATER NEEDS AND MONITOR FOR INSECTS.
6. PROVIDE SUPPLEMENTAL WATERING DURING 1-3 WINTERS.

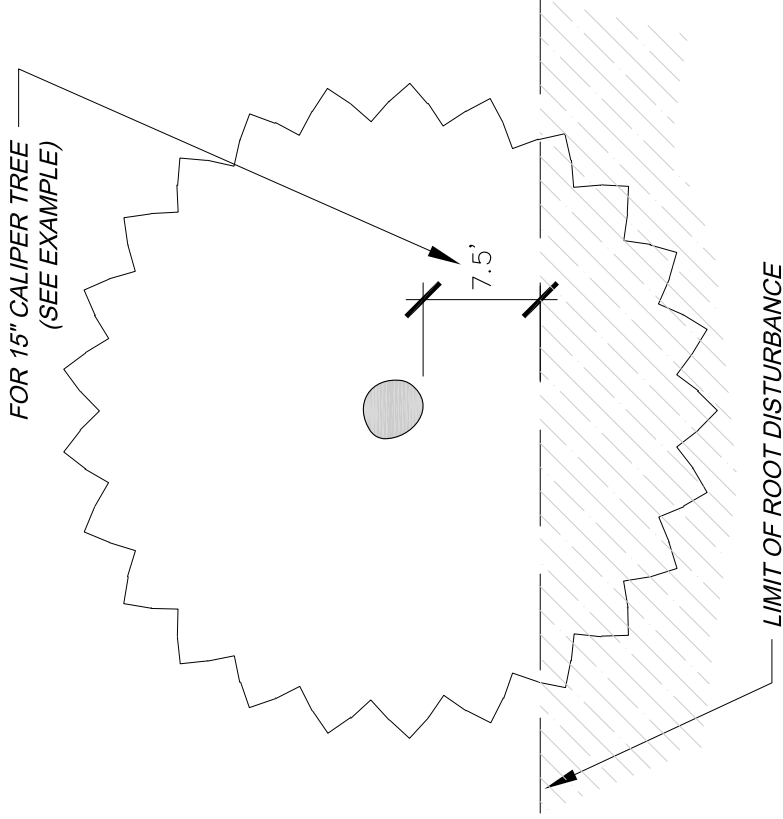

City of Aurora
Parks, Recreation & Open Space Dept.
Date: October 2020

**TREE PRESERVATION
MEASURES -- 1 SIDE**

**PROS
TP-2.0**

LIMITATIONS OF ROOT ZONE DISTURBANCE:

ROOT ZONE DISTURBANCE WITHIN THE DRIP LINE SHALL BE LIMITED TO ONE SIDE OF THE TRUNK OF TREES TO BE PRESERVED. MINIMUM DISTANCE BETWEEN THE TRUNK AND THE DISTURBANCE SHALL BE EQUAL TO 1/2 OF THE TREE'S DIAMETER CONVERTED TO FEET. (FOR EXAMPLE; FOR A TREE WITH A 15" DIAMETER TRUNK, THE DISTURBANCE CAN NOT BE CLOSER THAN 7.5 FEET FROM THE TRUNK.

REQUIRED TREATMENTS:

1. APPLY PREVENTATIVE SPRAY FOR MOUNTAIN PINE BEETLE (MPB) AND IPS TO PONDEROSA, AUSTRIAN & SCOTCH PINES. TREAT ALL BARK SURFACES, INCLUDING TOP BRANCHES.
2. IF DISTURBANCE LEAVES A CUT SLOPE WITHIN THE DRIFLINE, IMMEDIATELY APPLY MULCH AND WATER.
3. APPLY 3"-5" OF ORGANIC MULCH OVER THE AREA WITHIN THE DRIFLINE
4. EVERY 1-2 WEEKS, APPLY 50-100 GALLONS OF SUPPLEMENTAL WATER.
5. PROVIDE SUPPLEMENTAL WATER DURING 1-3 WINTERS
6. REGULARLY EVALUATE TREE TO DETERMINE IF TREE IS LEANING OR IF BRANCHES / LEAVES ARE AFFECTED BY ROOT LOSS.
7. INSPECT TREE 2-3 TIMES PER YEAR FOR WATER NEEDS AND MONITOR FOR INSECTS.
8. INSTALL STAKING OR SUPPORT FOR SMALLER PINE TREES.

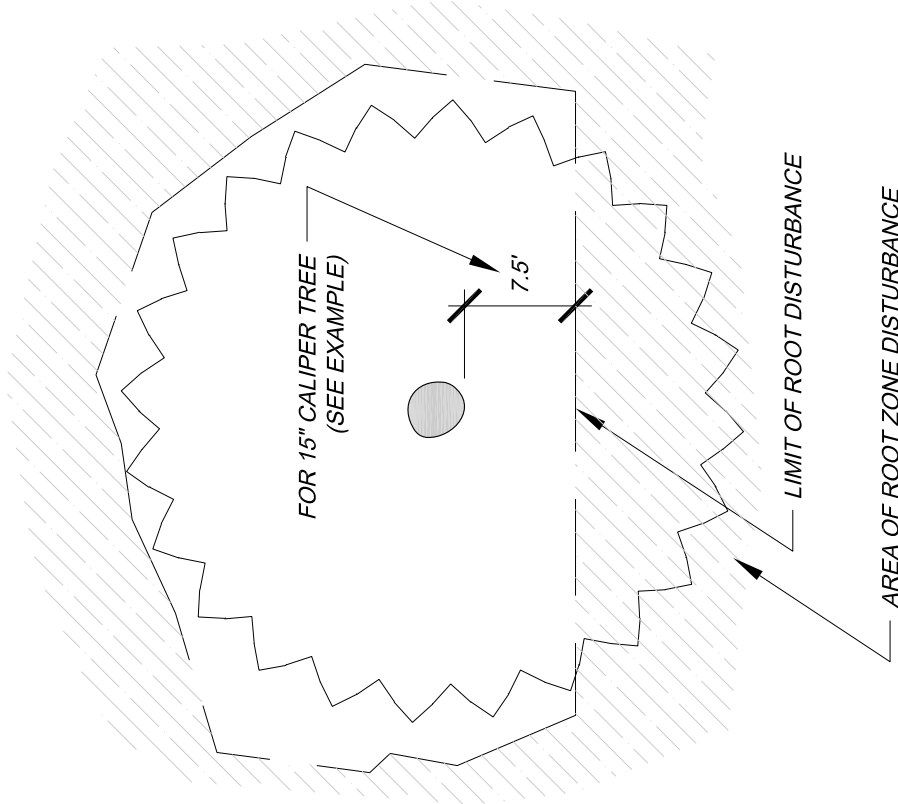

City of Aurora
Parks, Recreation & Open Space Dept.
Date: October 2020



**TREE PROTECTION
MEASURES -- 2+ SIDES**

**PROS
TP-2.1**

EXISTING TREE TO BE PROTECTED DURING CONSTRUCTION.

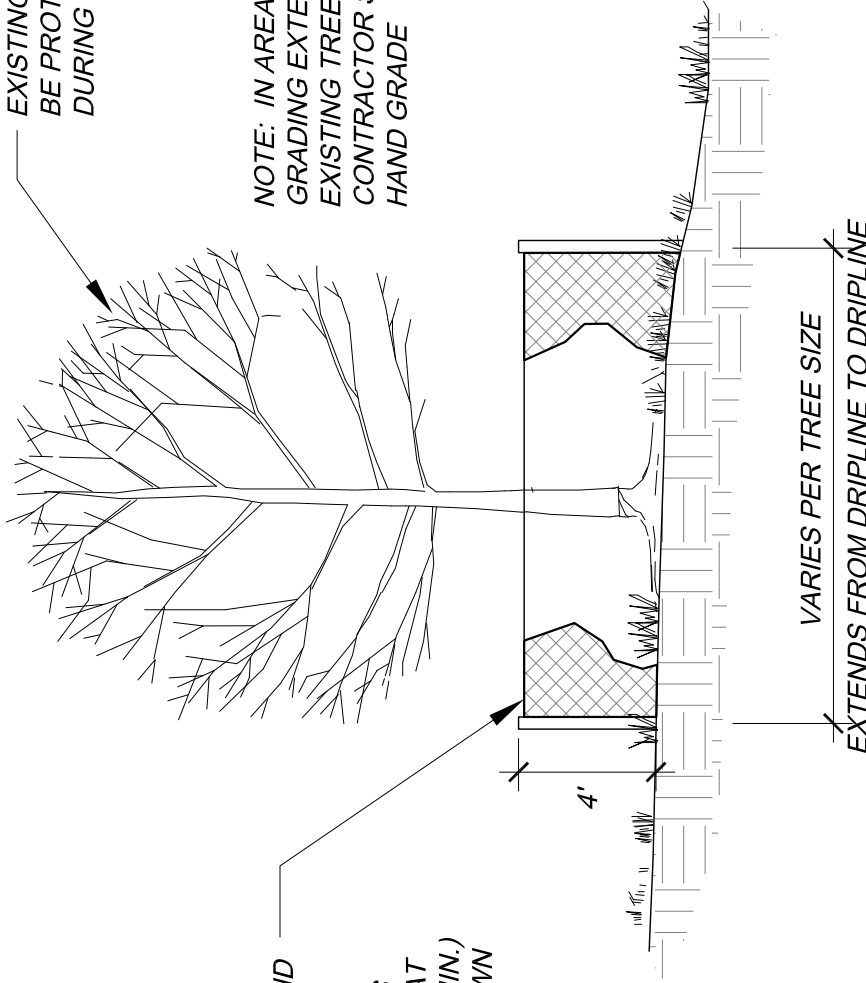

NOTE: IN AREAS WHERE GRADING EXTENDS INTO EXISTING TREE DRILINES, CONTRACTOR SHALL HAND GRADE

PROVIDE AND INSTALL BARRICADE FENCING AS SPECIFIED AT DRILINE (MIN.) OR AS SHOWN ON PLANS

VARIES PER TREE SIZE EXTENDS FROM DRILINE TO DRILINE

City of Aurora
Parks, Recreation & Open Space Dept.
Date: October 2020



TREE PROTECTION FENCING

**PROS
TP-3.0**

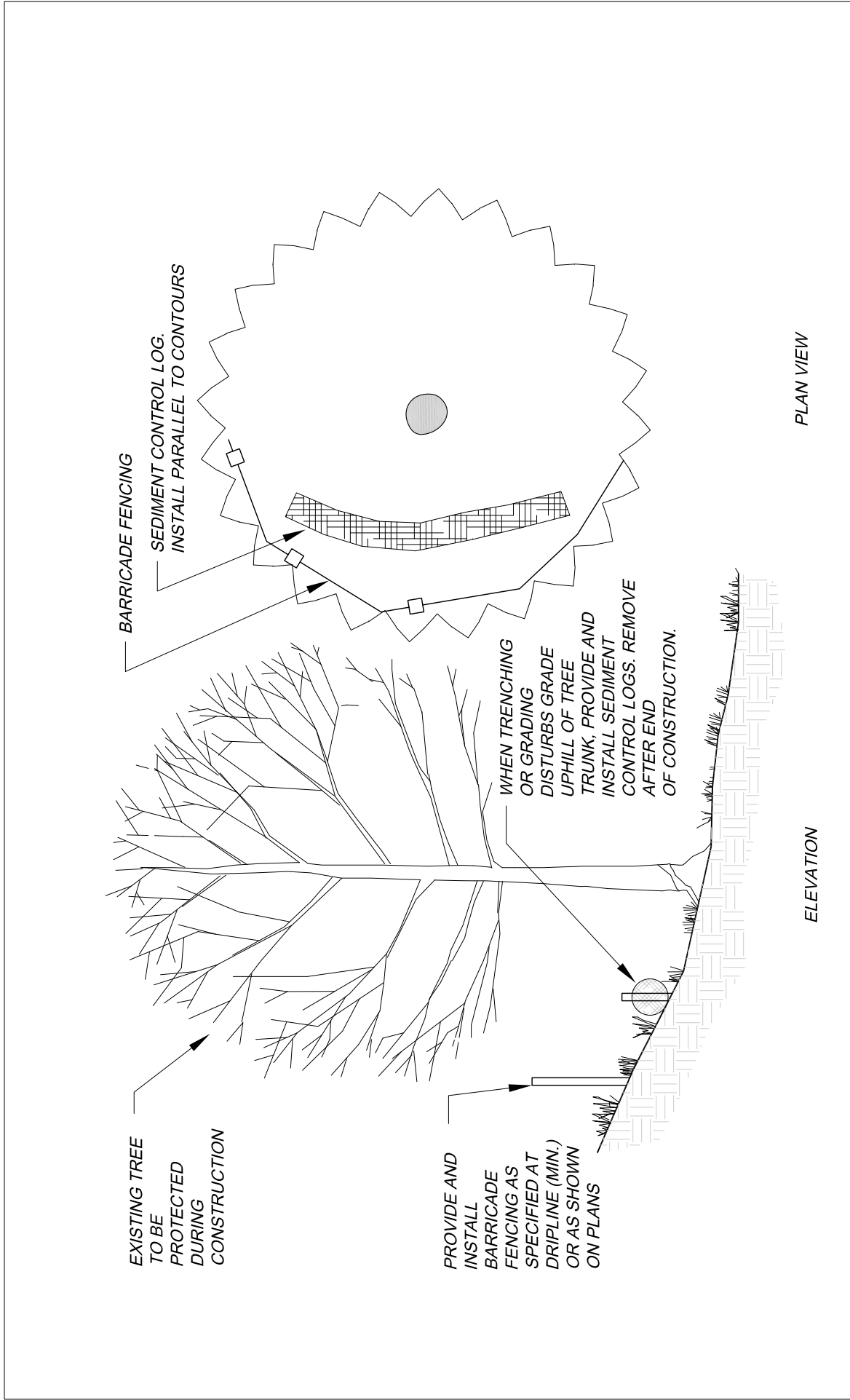

	<p>City of Aurora Parks, Recreation & Open Space Dept. Date: October 2020</p>	<p>TREE PROTECTION ON A SLOPE</p>	<p>PROS TP-3.1</p>
---	---	---------------------------------------	--------------------------------------

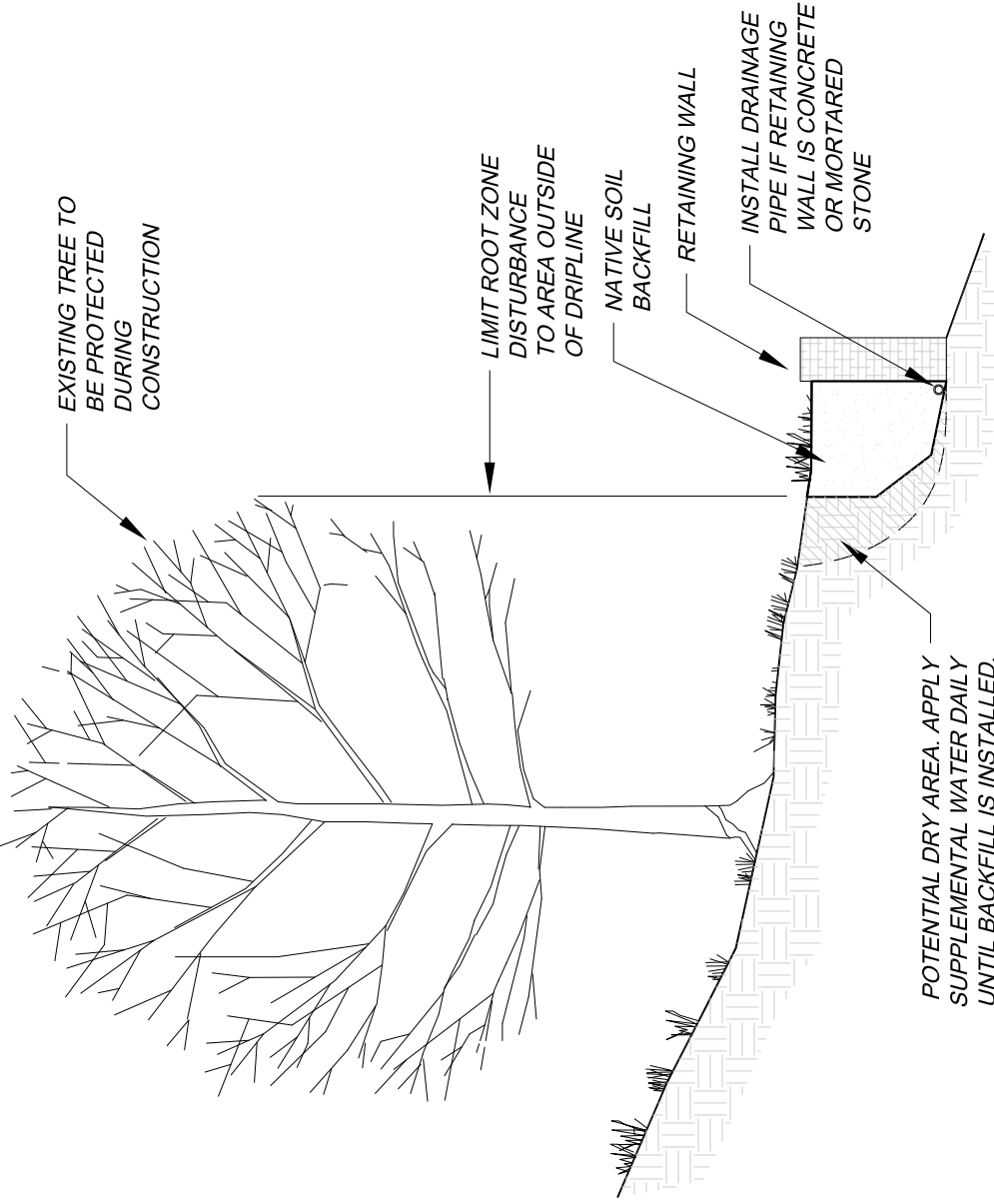

City of Aurora
 Parks, Recreation & Open Space Dept.
 Date: October 2020

**RETAINING WALL
 AT EXISTING TREE**

**PROS
 TP-3.2**

